

Fiyat Listesi / Şubat 2019

Let's Connect.



Weidmüller 

Weidmüller Fiyat Listesi / Şubat 2019

İçindekiler ve Önsöz	A + B	İçindekiler
W Serisi Ray Klemensleri ve Aksesuarları - Vida Bağlantı Teknolojisi	1 - 8	Klemens ve Aksesuarları
WMF Serisi Marshalling Ray Klemensleri - Vida Bağlantı Teknolojisi	9 - 10	
Z Serisi Ray Klemensleri ve Aksesuarları - Yay Bağlantı Teknolojisi	11 - 16	
Klippon Connect PUSH IN Klemens Serisi	17 - 24	
PUSH IN Serisi Ray Klemensleri ve Aksesuarları	25 - 27	
Marshalling, Güç Dağıtım Klemensleri ve Aksesuarları	28	
Mini Ray Klemensleri ve Aksesuarları (15 mm'lik Ray İçin)	29	
Klemens ve Bağlantı Aksesuarları	30 - 32	
Raylar ve Aksesuarları	33	
Pano içi LED Aydınlatma Ürünleri	34	
Markalama	35 - 49	Markalama PCB Fiş Soket El Aletleri
PCB - Baskılı Devre Klemensleri	50 - 52	
Rockstar Sanayi Tipi Fiş Soket	53 - 58	
El Aletleri	59 - 66	
Kutular	67 - 70	Kutu Yüksük Papuç SKP Kanal Spiral Kablo Bağ
Yüksükler ve Papuçlar	71 - 74	
Kablo Kanalları - Spiral Hortum ve Rakorlar	75 - 76	
Kablo Bağları	77 - 78	
U-Remote I/O Modülleri	79 - 85	U-Remote PLC I/O SAI Endüstriyel Ethernet Frontcom
SAI - Sensör Aktuatör Arayüzleri	86 - 89	
Endüstriyel Ethernet	90 - 96	
Frontcom® Vario	97 - 98	
Röleler ve Optokuplörler	99 - 112	Röleler ve Optokuplörler Analog Sinyal Dönüştürücü
Analog Sinyal Dönüştürücüler	113 - 118	
Enerji Analizörleri	119 - 120	Enerji Analizörleri Güç Kaynağı Parafudr PV Sistem
Güç Kaynakları	121 - 126	
Aşırı Gerilim Koruma Modülleri	127 - 130	
PV Sistemler için Ürünler ve Çözümler	131 - 133	
Sıralı Liste	134 - 148	Ürün Sıralı Listesi
Yetkili Bayilerimiz ve Otomasyon Partnerlerimiz	150 - 151	

Şirket Profili

Weidmüller, elektriksel bağlantılar, sinyal, veri, güç dağıtım ve işlenmesi konularında endüstriyel ortamlarda sunduğu çözümler ile sektöründe lider konuma sahip global bir firmadır.

Firmamız, genel merkezinin de bulunduğu Almanya / Detmold yerleşkesi ve üç kıtaya yayılan diğer fabrikalarında araştırma, geliştirme ve üretim faaliyetlerini yürütmekte olup, ürettiği elektronik ve elektriksel bağlantı ürünlerinin tüm dünya geneline satışını gerçekleştirmektedir. Bunun yanı sıra Weidmüller uzmanlardan oluşturduğu teknik ağ yapısı ile uygulamaya özel çözümler üreten mühendislik hizmetlerini de müşterilerine sunmaktadır.

Komple ürün ve hizmet portföyüyle toplam çözüm tedarikçisi olmayı amaçlayan Weidmüller, zengin ürün ve hizmetleriyle müşterilerin rekabetçi avantajlar kazanmalarını ve faaliyetlerine değer katmalarını sağlar.

Weidmüller, dünya genelinde 80'den fazla ülkede faaliyet gösteren üretim tesisleri, satış ofisleri ve temsilcilikleri ile müşterilerine hizmet vermektedir.

W Serisi Ray Klemensleri - Vida Bağlantı Teknolojisi

Weidmüller'in W serisi olan vida bağlantılı ray klemensleri uzun bir zamandan beri standartları belirlemektedir. Detaylarına kadar mükemmelleştirilmiş bir çok üstün özellikleri bu seriye zirvede bir pozisyonu garanti eder.

W serisi 0.06'dan 300 mm²'ye iletkenler için tüm genel elektrik uygulamalarına uygun bağlantı çözümü sunmaktadır.

W serisinin diğer bir avantajı da vidalı WQV serisi üst köprülerin yanında ZQV serisi vidasız üst köprülerde kullanılabilmesidir.

- ZQV serisi vidasız köprü kullanılması ile diğer vida bağlantılı klemensler ile karşılaştırıldığında önemli ölçüde zamandan kazanç sağlar.
- ZQV serisi vidasız köprüler 2.5 ve 4 mm² klemensler için 10 kutup'a kadar standarttır.
- 50 Kutuplu olarak tercih edilerek istenilen kutup sayısında kesilerek kullanılabilir.

Weidmüller'in patentli tasarımı sayesinde W serisi klemenslere aynı çapta iki iletken kolaylıkla bağlanabilir.

W Serisi Şu Klemens Tiplerini Kapsar ;

- **WDU** - Geçiş Klemensleri
- **WPE** - Topraklama Klemensleri
- **WNT** - Nötr Klemensleri
- **WDL** - Üç İletkenli Dağıtım Klemensleri
- **WTR** - Ölçme Ayırma Klemensleri
- **WSI** - Sigortalı Klemensler
- **WDK** - Çok Katlı Klemensler

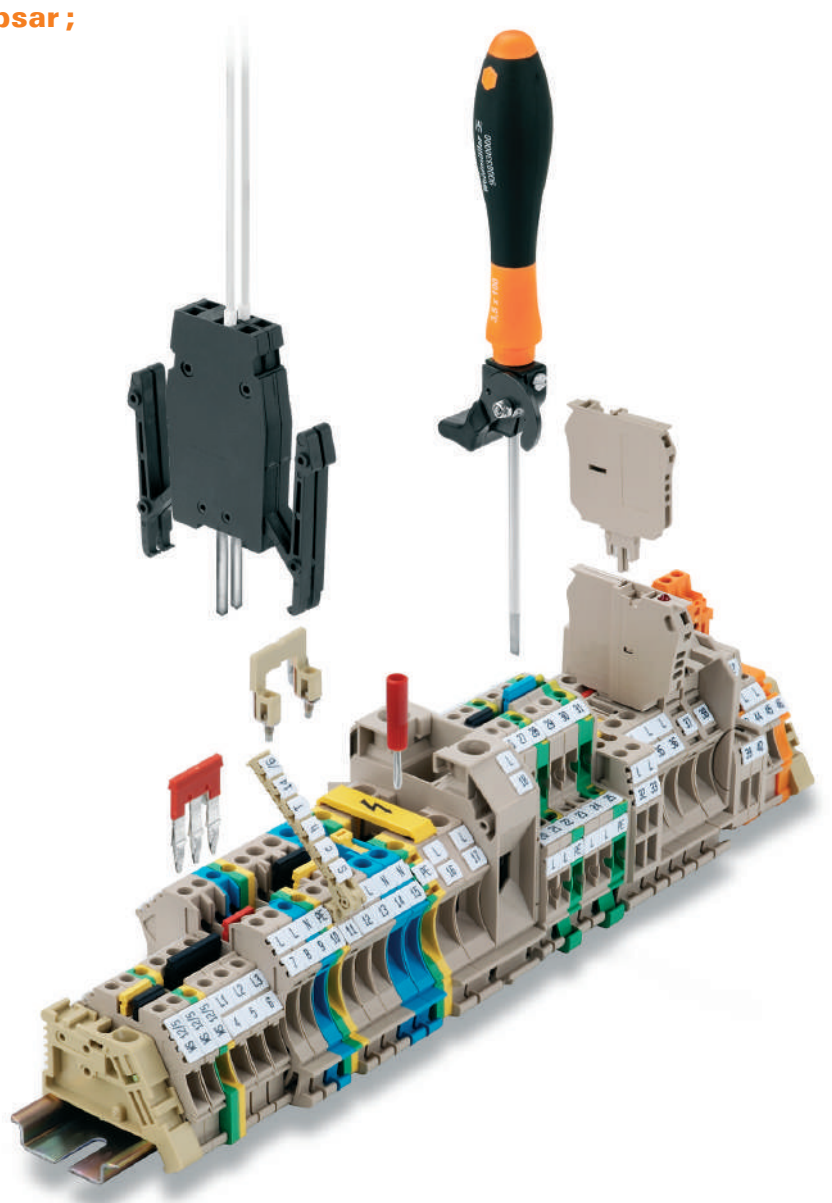

W Serisi Ray Klemensleri - Vida Bağlantı Teknolojisi



WDU 2.5



WDU 2.5 BL

Tip	V / A	Kesit - mm ² (Yüksüksüz)	Sipariş No	Fiyat/Birim	Ambalaj
Geçiş Klemensleri					
WDU 2.5	800 / 24	0.05 - 4 mm ²	1020000000	3,60 TL	100
WDU 2.5 BL	800 / 24	0.05 - 4 mm ²	1020080000	3,60 TL	100
WDU 4	800 / 32	0.5 - 6 mm ²	1020100000	4,45 TL	100
WDU 4 BL	800 / 32	0.5 - 6 mm ²	1020180000	4,45 TL	100
WDU 6	800 / 41	0.5 - 10 mm ²	1020200000	7,55 TL	100
WDU 6 BL	800 / 41	0.5 - 10 mm ²	1020280000	7,55 TL	100
WDU 10	1000 / 57	1.5 - 16 mm ²	1020300000	10,25 TL	50
WDU 10 BL	1000 / 57	1.5 - 16 mm ²	1020380000	10,25 TL	50
WDU 16	1000 / 76	1.5 - 25 mm ²	1020400000	13,85 TL	50
WDU 16 BL	1000 / 76	1.5 - 25 mm ²	1020480000	13,85 TL	50
WDU 35	1000 / 125	2.5 - 50 mm ²	1020500000	31,10 TL	40
WDU 35 BL	1000 / 125	2.5 - 50 mm ²	1020580000	31,10 TL	40
WDU 70/95	1000 / 232	16 - 120 mm ²	1024600000	248,55 TL	10
WDU 70/95 BL	1000 / 232	16 - 120 mm ²	1024680000	248,55 TL	10
WDU 120/150	1000 / 269	35 - 150 mm ²	1024500000	349,85 TL	10
WDU 120/150 BL	1000 / 269	35 - 150 mm ²	1024580000	349,85 TL	10
WDU 240	1000 / 415	70 - 240 mm ²	1802780000	378,55 TL	2
WDU 240 BL	1000 / 415	70 - 240 mm ²	1822210000	378,55 TL	2

Renk Tipleri



WDU 2.5	102000	102008	102006	103771	102002	102009	102004	102001	103770	103680
WDU 4	102010	102018	103676	103781	102012	102016	102014	102011	103782	103670
WDU 6	102020	102028	102026	-	104022	102029	102024	102021	-	-
WDU 10	102030	102038	102036	-	-	-	102034	102031	-	-
WDU 16	102040	102048	-	-	-	-	-	-	-	-
WDU 35	102050	102058	-	-	-	-	-	-	-	-

Not: Renkli klemenslerde fiyat farklılıkları bulunmaktadır, bilgi için lütfen fiyat talebinde bulununuz.



WDU 2.5/1.5/ZR

Tip	V / A	Kesit - mm ² (Yüksüksüz)	Sipariş No	Fiyat/Birim	Ambalaj
İkili Geçiş Klemensleri					
WDU 2.5/1.5/ZR	800 / 24	0.5 - 4 mm ² / 2 x 0.5 - 1.5 mm ²	1024700000	21,55 TL	100
WDU 1.5/ZZ	800 / 17.5	0.5 - 2.5 mm ²	1031400000	21,55 TL	100
WDU 4/ZR	800 / 32	0.5 - 6 mm ²	1905140000	22,95 TL	50
WDU 4/ZZ	800 / 32	1.5 - 6 mm ²	1905060000	25,40 TL	50
WDU 10/ZR	800 / 57	1.5 - 16 mm ²	1042400000	34,40 TL	50

İki Katlı Klemensler (Her İki Kat Köprülenebilir)

WDK 2.5	400 / 24	0.5 - 4 mm ²	1021500000	14,10 TL	100
WDK 2.5 BL	400 / 24	0.5 - 4 mm ²	1021580000	14,10 TL	100
WDK 2.5V	400 / 24	0.5 - 4 mm ²	1022300000	46,30 TL	100
WDK 10	800 / 57	1.5 - 16 mm ²	1186740000	49,75 TL	50
WDK 10 BL	800 / 57	1.5 - 16 mm ²	1186750000	49,75 TL	50

Üç Katlı Klemensler (Her Üç Kat Köprülenebilir)

DLD 2.5 DB	250 / 24	0.5 - 4 mm ²	1784180000	31,50 TL	50
DLD 2.5/PE DB	250 / 24	0.5 - 4 mm ²	1783790000	36,80 TL	50
WDL 2.5/S/N/L/PE	400 / 24	0.5 - 4 mm ²	1030700000	31,50 TL	50
WDL 2.5/S/L/L/PE	400 / 24	0.5 - 4 mm ²	1031100000	30,65 TL	50
WDL 2.5/N/L/PE	400 / 24	0.5 - 4 mm ²	1029900000	39,20 TL	50
WDL 2.5/L/L/PE	400 / 24	0.5 - 4 mm ²	1030200000	37,75 TL	50



WDK 2.5



DLD 2.5 DB



DLI 2.5 DB



MAK 2.5 DB



WPE 2.5



WTR 2.5



WDK 2.5/TR-DU



WDK 2.5/TR-DU-PE



WTL 6/1



WTL 6/2

Tip	V / A	Kesit - mm ² (Yüksüksüz)	Sipariş No	Fiyat/Birim	Ambalaj
Sensör - Aktüatörler için Köprülenebilir Beslemeli, Üç Katlı Klemensler					
DLI 2.5 DB	250 / 24	0.5 - 4 mm ²	1783820000	34,90 TL	100
DLI 2.5/LD-RT/PNP +- DB	30 / 24	0.5 - 4 mm ²	1783980000	65,95 TL	100
DLI 2.5/LD-RT/NPN +- DB	30 / 24	0.5 - 4 mm ²	1783950000	65,95 TL	100
DLA 2.5 DB	250 / 17.5	0.5 - 4 mm ²	1783560000	44,50 TL	100
DLA 2.5/LD-RT DB	30 / 17.5	0.5 - 4 mm ²	1783600000	61,65 TL	100
DLA 2.5/D DB	250 / 17.5	0.5 - 4 mm ²	1783590000	42,50 TL	100
Dört Katlı Klemens (3 Faz + Toprak, Motor Bağlantıları İçin)					
MAK 2.5 DB	500 / 24	0.5 - 4 mm ²	7917030000	57,85 TL	50
VLI 1.5 DB	250 / 17.5	0.5 - 2.5 mm ²	1784120000	28,70 TL	50
VLI 1.5/PE DB	250 / 17.5	0.5 - 2.5 mm ²	1784130000	41,65 TL	50
Topraklama Klemensleri					
WPE 2.5	800	0.05 - 4 mm ²	1010000000	15,05 TL	100
WPE 4	800	0.5 - 6 mm ²	1010100000	19,80 TL	100
WPE 6	1000	0.5 - 10 mm ²	1010200000	26,25 TL	50
WPE 10	1000	1.5 - 16 mm ²	1010300000	27,20 TL	50
WPE 16	1000	1.5 - 25 mm ²	1010400000	39,70 TL	50
WPE 35	800	2.5 - 50 mm ²	1010500000	63,10 TL	25
WPE 70/95	1000	16 - 95 mm ²	1037300000	359,35 TL	10
WPE 120/150	1000	95 - 150 mm ²	1019700000	514,00 TL	10
Nötr (N) - Ayrırma Klemensleri (10x3 mm'lik Baralar İçin)					
WNT 2.5 10X3	400 / 24	0.13 - 4 mm ²	1010680000	25,40 TL	100
WNT 4 10X3	400 / 32	0.5 - 6 mm ²	1010780000	25,85 TL	100
WNT 6 10X3	400 / 41	0.5 - 10 mm ²	1010880000	29,15 TL	50
WNT 10 10X3	400 / 57	1.5 - 16 mm ²	1010980000	34,40 TL	50
WNT 16N 10X3	400 / 76	1.5 - 25 mm ²	1019000000	42,05 TL	50
Ölçme Ayrırma Klemensleri					
WTR 2.5	500 / 24	0.5 - 2.5 mm ² / Test ayırma	1855610000	32,00 TL	100
WTR 2.5 STB2.3	500 / 24	0.5 - 2.5 mm ² / Test ayırma / Test Soket	1855620000	35,90 TL	100
WTR 2.5/ZZ	400 / 14	0.5 - 2.5 mm ² / Test ayırma / iki giriş, iki çıkış	1039900000	39,70 TL	100
WTR 4	400 / 32	0.5 - 4 mm ² / Test ayırma	7910180000	37,75 TL	50
WTR 4 STB	400 / 32	0.5 - 4 mm ² / Test ayırma / Test Soket	7910210000	42,05 TL	50
WTR 4/ZZ	500 / 27	0.5 - 4 mm ² / Test ayırma / iki giriş, iki çıkış	1905090000	45,85 TL	50
WTR 4/ZZ STB	500 / 27	0.5 - 4 mm ² / Test ayırma / Test Soket / İki giriş, iki çıkış	1905100000	51,10 TL	50
WDK 2.5/TR-DU	690 / 24	0.5 - 2.5 mm ² / Test ayırma / İki Katlı	1247290000	55,90 TL	50
WDK 2.5/TR-DU STB	690 / 24	0.5 - 2.5 mm ² / Test ayırma / Test Soket / İki Katlı	1247310000	63,10 TL	50
WDK 2.5/TR-DU-PE	690 / 24	0.5 - 2.5 mm ² / Test ayırma / Üç Katlı	1247420000	89,85 TL	50
WDK 2.5/TR-DU-PE STB	690 / 24	0.5 - 2.5 mm ² / Test ayırma / Test Soket / Üç Katlı	1247430000	99,35 TL	50
WTL 4	500 / 32	0.5 - 4 mm ² / Sürgü ayırma	1754960000	36,30 TL	50
WTL 4/STB	500 / 32	0.5 - 4 mm ² / Sürgü ayırma / Test Soket	1754970000	39,20 TL	50
WTL 6/1 EN	630 / 41	0.5 - 6 mm ² / Sürgü ayırma	1934810000	42,50 TL	50
WTL 6/1 EN STB	630 / 41	0.5 - 6 mm ² / Sürgü ayırma / Test Soket	1934820000	52,10 TL	50
WTL 6/1	400 / 41	0.5 - 6 mm ² / Sürgü ayırma	1016700000	33,95 TL	50
WTL 6/1/STB	400 / 41	0.5 - 6 mm ² / Sürgü ayırma / Test Soket	1016900000	34,40 TL	50
WTD 6/1 EN	630 / 41	0.5 - 6 mm ² / Direk Besleme	1934830000	37,15 TL	50
WTL 6/2	500 / 41	0.5 - 6 mm ² / Sürgü ayırma / Test Soket	1017700000	45,35 TL	50
WTL 6/3	500 / 41	0.5 - 6 mm ² / Sürgü ayırma	1018800000	54,95 TL	50
WTL 6/3/STB	500 / 41	0.5 - 6 mm ² / Sürgü ayırma / Test Soket	1018600000	74,10 TL	50

W Serisi Ray Klemensleri - Vida Bağlantı Teknolojisi



WSI 4



KDKS 1/35 DB



WSI 25/1 10x38



WTR 2.5/SI



WDK 2.5 1D A.2



WDU 1.5/BLZ 5.08



WDU 2.5N

Tip	V / A	Kesit - mm ² (Yüksüksüz)	Sipariş No	Fiyat/Birim	Ambalaj
Sigortalı Klemensler					
WSI 4/2	500 / 6.3	0.5 - 4 mm ² / G25 Sigorta	1880430000	21,05 TL	25
WSI 4/2/LD 10-36V AC/DC	500 / 6.3	0.5 - 4 mm ² / G25 Sigorta / LED	1880410000	48,75 TL	25
WSI 4/2/LD 30-70V AC/DC	500 / 6.3	0.5 - 4 mm ² / G25 Sigorta / LED	1880440000	48,75 TL	25
WSI 4/2/LD 60-150V AC/DC	500 / 6.3	0.5 - 4 mm ² / G25 Sigorta / LED	1880420000	48,75 TL	25
WSI 4/2/LD 140-250V AC/DC	500 / 6.3	0.5 - 4 mm ² / G25 Sigorta / LED	1880390000	48,75 TL	25
WSI 4	500 / 6.3	0.5 - 4 mm ² / G20 Sigorta	1886580000	41,05 TL	50
WSI 4/LD 10-36V AC/DC	500 / 6.3	0.5 - 4 mm ² / G20 Sigorta / LED	1886590000	63,10 TL	50
WSI 4/LD 30-70V AC/DC	500 / 6.3	0.5 - 4 mm ² / G20 Sigorta / LED	1886560000	63,10 TL	50
WSI 4/LD 60-150V AC/DC	500 / 6.3	0.5 - 4 mm ² / G20 Sigorta / LED	1886570000	63,10 TL	50
WSI 4/LD 140-250V AC/DC	500 / 6.3	0.5 - 4 mm ² / G20 Sigorta / LED	1886550000	63,10 TL	50
KDKS 1/35 DB	500 / 6.3	0.5 - 4 mm ² / G20 Sigorta / İki katlı / LED	9532440000	55,90 TL	50
WSI 6	500 / 6.3	0.5 - 6 mm ² / G20 Sigorta	1011000000	24,75 TL	50
WSI 6/LD 10-36V DC/AC	500 / 6.3	0.5 - 4 mm ² / G20 Sigorta / LED	1011300000	60,75 TL	50
WSI 6/LD 30-70V DC/AC	500 / 6.3	0.5 - 4 mm ² / G20 Sigorta / LED	1012200000	60,75 TL	50
WSI 6/LD 60-150V DC/AC	500 / 6.3	0.5 - 4 mm ² / G20 Sigorta / LED	1012300000	60,75 TL	50
WSI 6/LD 250AC	500 / 6.3	0.5 - 4 mm ² / G20 Sigorta / LED	1012400000	60,75 TL	50
WSI 25/1 10x38	690 / 32	0.5 - 25mm ² / Buşon Sigorta / 1 Kutup	1966020000	61,65 TL	12
WSI 25/2 10x38	690 / 32	0.5 - 25mm ² / Buşon Sigorta / 2 Kutup	1966090000	113,75 TL	6
WSI 25/3 10x38	690 / 32	0.5 - 25mm ² / Buşon Sigorta / 3 Kutup	1966080000	185,90 TL	4
WSI 25/1 10x38/LED	690 / 32	0.5 - 25mm ² / Buşon Sigorta / 1 Kutup / LED	1966060000	106,10 TL	12
WSI 25/1 10x38 1KV	1000 / 32	0.5 - 25mm ² / Buşon Sigorta / 1 Kutup	1137790000	134,30 TL	12
WSI 25/1 10x38/LED 1KV	1000 / 32	0.5 - 25mm ² / Buşon Sigorta / 1 Kutup / LED	1137780000	249,00 TL	12
WTR 2.5/SI	400 / 6.3	0.5 - 2.5 mm ² / G20 Sigorta	1763940000	52,10 TL	25
WTR 2.5/SI LD 36V	400 / 6.3	0.5 - 2.5 mm ² / G20 Sigorta / LED	1763950000	93,20 TL	25
WTR 4 SI	400 / 6.3	0.5 - 4 mm ² / G20 Sigorta	7910240000	59,80 TL	25
WTR 4/SI LD 36V	400 / 6.3	0.5 - 4 mm ² / G20 Sigorta / LED	7914370000	104,15 TL	25
WTR 4/SI LD 70V	400 / 6.3	0.5 - 4 mm ² / G20 Sigorta / LED	7914380000	104,15 TL	25
WTR 4/SI LD 150V	400 / 6.3	0.5 - 4 mm ² / G20 Sigorta / LED	7914390000	104,15 TL	25
WTR 4/SI LD 250V	400 / 6.3	0.5 - 4 mm ² / G20 Sigorta / LED	7914400000	104,15 TL	25
BEST/D	Max 250	WTR 2.5/ 1N4007 diyotlu fiş	1878560000	52,10 TL	50
Sigortalı					
G 20/0.25A/F	0.25	Sigorta	0430500000	9,00 TL	10
G 20/0.50A/F	0.5	Sigorta	0430600000	9,00 TL	10
G 20/1.00A/F	1	Sigorta	0430700000	9,00 TL	10
G 20/2.00A/F	2	Sigorta	0430900000	9,00 TL	10
Diyotlu Klemensler					
WDK 2.5 1D A.2	400 / 10	0.05 - 4 mm ²	1023300000	58,30 TL	25
WDK 2.5 1D A.1	400 / 10	0.05 - 4 mm ²	1023400000	58,30 TL	25
WDK 2.5 2D	400 / 10	0.05 - 4 mm ²	1023500000	58,30 TL	25
WDK 2.5 2D 2.A	400 / 10	0.05 - 4 mm ²	1022600000	58,30 TL	25
WDK 2.5 LD RT 24VDC +-	.24 / 10	0.05 - 4 mm ²	1023600000	81,75 TL	25
Soket Bağlantılı Klemensler					
WDU 1.5/BLZ 5.08	250 / 16	0.5 - 4 mm ² /2xBLZ Soket	1577340000	19,55 TL	100
WDK 2.5/BLZ/5.08/ZA	250 / 16	0.5 - 4 mm ² /2xBLZ Soket	1034400000	25,40 TL	100
WT4 4AN/2	800 / 32	0.5 - 6 mm ² /2xZP Soket	1107680000	27,20 TL	50
Kompakt (Küçük) Tip Klemensler / Geçiş Klemensleri					
WDU 2.5N	500 / 24	0.05 - 4 mm ²	1023700000	4,30 TL	100
WDU 2.5N BL	500 / 24	0.05 - 4 mm ²	1023780000	4,30 TL	100
WDU 4N	500 / 32	0.5 - 6 mm ²	1042600000	9,60 TL	100

Serinin devamı sayfa 5



WDK 2.5N



WPE 2.5N



WPE 50N



WFF 35



WEW 35/2



ZEW 35



WAP 2.5-10



WAP 2.5-10 BL

Tip	V / A	Kesit - mm ² (Yüksüksüz)	Sipariş No	Fiyat/Birim	Ambalaj
WDU 4N BL	500 / 32	0.5 - 6 mm ²	1042680000	9,60 TL	100
WDU 16N	690 / 76	1.5 - 25 mm ²	1036100000	23,40 TL	50
WDU 16N BL	690 / 76	1.5 - 25 mm ²	1036180000	23,40 TL	50
WDU 35N	500 / 125	2.5 - 50 mm ²	1040400000	49,75 TL	20
WDU 35N BL	500 / 125	2.5 - 50 mm ²	1040480000	49,75 TL	20
WDU 50N	1000 / 150	16 - 70 mm ²	1820840000	125,20 TL	10
WDU 50N BL	1000 / 150	16 - 70 mm ²	1820850000	125,20 TL	10
WDU 70N/35	1000 / 192	35 - 95 mm ²	9512190000	169,20 TL	10
WDU 70N/35 BL	1000 / 192	35 - 95 mm ²	9512420000	169,20 TL	10
WDU 95N/120N	1000 / 269	16.0 - 150 mm ²	1820550000	218,35 TL	5
WDU 95N/120N BL	1000 / 269	16.0 - 150 mm ²	1820560000	218,35 TL	5

Kompakt (Küçük) İki Katlı Klemensler (Her İki Kat Köprülenebilir)

WDK 2.5N	800 / 24	0.05 - 4 mm ²	1041600000	17,70 TL	100
WDK 2.5N BL	800 / 24	0.05 - 4 mm ²	1041680000	17,70 TL	100
WDK 2.5N V	800 / 24	0.5 - 4 mm ² - İki kat köprülü	1041610000	55,40 TL	100
WDK 2.5N DU-PE	800 / 24	0.5 - 4 mm ² - Alt kat topraklama	1041650000	48,75 TL	100
WDK 4N	800 / 32	0.5 - 6 mm ²	1041900000	20,60 TL	100
WDK 4N BL	800 / 32	0.5 - 6 mm ²	1041980000	20,60 TL	100
WDK 4N V	800 / 32	0.5 - 6 mm ² - İki kat köprülü	1041910000	55,90 TL	100
WDK 4N DU-PE	800 / 32	0.5 - 6 mm ² - Alt kat topraklama	1041950000	48,25 TL	100

Kompakt (Küçük) Topraklama Klemensleri

WPE 2.5N	500	0.05 - 4 mm ²	1016200000	34,90 TL	100
WPE 4N	500	0.13 - 6 mm ²	1042700000	35,90 TL	100
WPE 16N	400	1.50 - 25 mm ²	1019100000	64,05 TL	50
WPE 35N	400	2.50 - 50 mm ²	1717740000	87,50 TL	20
WPE 50N	1000	10.0 - 70 mm ²	1846040000	238,50 TL	10
WPE 70N/35	1000	10.0 - 95 mm ²	9512200000	320,20 TL	10
WPE 95N/120N	1000	16.0 - 150 mm ²	1846030000	360,85 TL	5

Papuç Bağlantılı Klemensler

WFF 35	1100 / 109	2.5...50 mm ²	1028300000	109,90 TL	10
WFF 35 BL	1100 / 109	2.5...50 mm ²	1028380000	109,90 TL	10
WFF 70	1100 / 167	2.5...95 mm ²	1028400000	153,45 TL	10
WFF 70 BL	1100 / 167	2.5...95 mm ²	1028480000	153,45 TL	10
WFF 120	1100 / 234	16...150 mm ²	1028500000	219,85 TL	5
WFF 120 BL	1100 / 234	16...150 mm ²	1028580000	219,85 TL	5
WFF 185	1100 / 307	25...240 mm ²	1028600000	301,60 TL	4
WFF 185 BL	1100 / 307	25...240 mm ²	1028680000	301,60 TL	4
WFF 300	1100 / 425	50...300 mm ²	1028700000	357,95 TL	4

Tip	Açıklama	Sipariş No	Fiyat/Birim	Ambalaj
Klemens Durdurucuları				
EW 35	Vidalı Küçük Tip	0383560000	4,45 TL	50
WEW 35/1	Vidalı Tip	1059000000	30,10 TL	50
WEW 35/2	Vidalı Tip	1061200000	18,85 TL	100
WEW 35/2 SW	Vidalı Tip Siyah	1061210000	18,85 TL	100
ZEW 35	Vidasız Tip 6mm Kalınlık	9540000000	4,50 TL	20
ZEW 35/2	Vidasız Tip 8mm Kalınlık	8630740000	5,20 TL	20
ZEW 35/2 SW	Vidasız Tip 8mm Kalınlık Siyah	1162610000	5,75 TL	20

Nihayet Plakaları

WAP 2.5-10	WDU 2.5-10 / WPE / WSI / WTR Serisi	1050000000	3,30 TL	50
WAP 2.5-10 BL	WDU 2.5-10 / WPE / WSI / WTR Serisi Mavi	1050080000	3,30 TL	50

Serinin devamı sayfa 6

W Serisi Ray Klemensleri - Vida Bağlantı Teknolojisi



WAP 16+35 WTW 2.5-10



ZAP/TW 1



WAP WDK 2.5N/TR-DU



WAH 35



WQV 2.5/2



WQV 2.5/10

Tip	Açıklama	Sipariş No	Fiyat/Birim	Ambalaj	
WAP 16+35 WTW 2.5-10	WDU 16-35 Serisi	1050100000	4,70 TL	20	
WAP 16+35 WTW 2.5-10 BL	WDU 16-35 Serisi Mavi	1050180000	4,70 TL	20	
WAP WDU/WTR4/ZR	WTR4/ZR Serisi	1905070000	6,55 TL	50	
WAP WDU/WTR4/ZZ	WTR4/ZZ Serisi	1905150000	6,55 TL	50	
WAP WDK2.5	WDK 2.5 Serisi	1059100000	6,35 TL	20	
WAP WDK2.5 BL	WDK 2.5 Serisi Mavi	1059180000	6,35 TL	20	
WAP WDK10	WDK 10 Serisi	1186720000	14,20 TL	20	
WAP WDK10 BL	WDK 10 Serisi Mavi	1186730000	14,20 TL	20	
AP DLI2.5 DB	DLI / DLA Serisi	1783550000	10,00 TL	20	
AP DLD2.5 DB	DLD Serisi	1784210000	10,00 TL	20	
WAP WDL2.5	WDL Serisi	1067800000	6,00 TL	20	
AP MAK2.5 DB	MAK Serisi	7917000000	12,00 TL	20	
AP VLI1.5 DB	VLI 1.5 Serisi	1784150000	7,00 TL	20	
AP VLI1.5/PE DB	VLI 1.5/PE Serisi	1784160000	7,45 TL	20	
WAP WTR2.5/ZZ	WTR2.5/ZZ Serisi	1074600000	6,15 TL	20	
ZAP/TW 1	ZDU 2.5	1608740000	3,60 TL	50	
WAP WTL4/2	WTL 4/2 Serisi	1881640000	7,65 TL	50	
WAP WTL6/1 EN	WTL 6/1 ENSerisi	1957710000	7,15 TL	20	
WAP WTL6/1	WTL 6/1 Serisi	1068300000	5,75 TL	20	
WAP WDK 2.5N/TR-DU	WDK 2.5N/TR-DU Serisi	1839850000	8,10 TL	50	
WAP WSI4/2	WSI 4/2 Serisi	1880450000	2,75 TL	50	
AP KDKS1 DB	KDKS 1/35 Serisi	9532470000	13,00 TL	20	
WAP WDU2.5N/4N	WDU N Serisi 2.5-4	1060000000	3,90 TL	50	
WAP WDU2.5N/4N BL	WDU N Serisi 2.5-4 Mavi	1060080000	3,90 TL	50	
WAP WDK2.5/4 N	WDK N Serisi 2.5-4	1084000000	7,00 TL	20	
WAP WDK2.5/4 N BL	WDK N Serisi 2.5-4 Mavi	1084080000	7,00 TL	20	
TW SAKD2.5N	WDU2.5N Serisi Ayırma Plakası	0191860000	7,00 TL	20	
WTW EN	WDU16N-35N Serisi Ayırma Plakası	1058800000	23,40 TL	20	
WTW WTL6/1 DB	WTL6/1 Serisi Ayırma Plakası	1068400000	9,05 TL	20	
WHP 2.5-35N/10x3 BL	WNT Serisi Bara Tutucu (10x3 mm Bara)	1050280000	7,30 TL	20	
WFF Serisi Üst Kapak					
WAH 35	WFF 35 Üst Kapak	1064460000	17,70 TL	20	
WAH 35 BL	WFF 35 Üst Kapak Mavi	1064480000	17,70 TL	20	
WAH 70 BE	WFF 70 Üst Kapak	1064560000	21,05 TL	20	
WAH 70 BL	WFF 70 Üst Kapak Mavi	1064580000	21,05 TL	20	
WAH 120	WFF 120 Üst Kapak	1064660000	25,40 TL	20	
WAH 120 BL	WFF 120 Üst Kapak Mavi	1064680000	25,40 TL	20	
WAH 185/300 BE	WFF 185/300 Üst Kapak	1064760000	38,95 TL	10	
WAH 185/300 BL	WFF 185/300 Üst Kapak Mavi	1064780000	38,95 TL	10	
Vidalı Klemens Üst Köprü					
WQV 2.5/2	32	2 Kutup	1053660000	7,15 TL	50
WQV 2.5/3	32	3 Kutup	1053760000	10,05 TL	50
WQV 2.5/4	32	4 Kutup	1053860000	11,00 TL	50
WQV 2.5/5	32	5 Kutup	1053960000	12,90 TL	10
WQV 2.5/6	32	6 Kutup	1054060000	14,85 TL	10
WQV 2.5/7	32	7 Kutup	1054160000	17,15 TL	10
WQV 2.5/8	32	8 Kutup	1054260000	19,55 TL	10
WQV 2.5/9	32	9 Kutup	1054360000	21,95 TL	10
WQV 2.5/10	32	10 Kutup	1054460000	27,20 TL	20

Serinin devamı sayfa 7



Tip	A	Kutup Sayısı	Sipariş No	Fiyat/Birim	Ambalaj
WQV 2.5/15	32	15 Kutup	1059660000	37,75 TL	10
WQV 2.5/20	32	20 Kutup	1577570000	52,10 TL	10
WQV 2.5/32	32	32 Kutup	1577600000	82,20 TL	10
WQV 4/2	41	2 Kutup	1051960000	9,05 TL	50
WQV 4/3	41	3 Kutup	1054560000	13,35 TL	50
WQV 4/4	41	4 Kutup	1054660000	17,15 TL	50
WQV 4/5	41	5 Kutup	1057860000	19,10 TL	10
WQV 4/6	41	6 Kutup	1057160000	22,75 TL	10
WQV 4/7	41	7 Kutup	1057260000	26,35 TL	10
WQV 4/10	41	10 Kutup	1052060000	40,55 TL	20
WQV 6/2	57	2 Kutup	1052360000	9,05 TL	50
WQV 6/3	57	3 Kutup	1054760000	13,25 TL	50
WQV 6/4	57	4 Kutup	1054860000	17,15 TL	50
WQV 6/5	57	5 Kutup	1062660000	21,80 TL	50
WQV 6/6	57	6 Kutup	1062670000	25,85 TL	50
WQV 6/7	57	7 Kutup	1062680000	29,65 TL	50
WQV 6/10	57	10 Kutup	1052260000	40,55 TL	20
WQV 10/2	57	2 Kutup	1052560000	10,05 TL	50
WQV 10/3	57	3 Kutup	1054960000	14,30 TL	50
WQV 10/4	57	4 Kutup	1055060000	21,05 TL	50
WQV 10/10	57	10 Kutup	1052460000	46,25 TL	20
WQV 16/2	101/76	2 Kutup	1053260000	12,15 TL	50
WQV 16/3	101/76	3 Kutup	1055160000	16,65 TL	50
WQV 16/4	101/76	4 Kutup	1055260000	22,40 TL	50
WQV 16/10	101/76	10 Kutup	1053360000	50,65 TL	10
WQV 16N/2	101/76	2 Kutup	1636560000	12,00 TL	50
WQV 16N/3	101/76	3 Kutup	1636570000	16,65 TL	50
WQV 16N/4	101/76	4 Kutup	1636580000	22,40 TL	50
WQV 35/2	112	2 Kutup	1053060000	16,65 TL	50
WQV 35/3	112	3 Kutup	1055360000	22,40 TL	50
WQV 35/4	112	4 Kutup	1055460000	32,00 TL	50
WQV 35/10	112	10 Kutup	1053160000	76,00 TL	10
WQV 35N/2	101	2 Kutup	1079200000	24,85 TL	20
WQV 35N/3	101	3 Kutup	1079300000	34,90 TL	20
WQV 35N/4	101	4 Kutup	1079400000	49,25 TL	20
WQV 50N/2	150	2 Kutup	1834060000	48,75 TL	5
WQV 50N/3	150	3 Kutup	1834070000	68,40 TL	5
WQV 50N/4	150	4 Kutup	1834080000	89,35 TL	5
WQV 70N/2	192	2 Kutup	9512240000	63,10 TL	5
WQV 70N/3	192	3 Kutup	9512250000	91,80 TL	5
WQV 70N/4	192	4 Kutup	9531290000	115,70 TL	5
WQV 70/95/2	192	2 Kutup	1063500000	151,95 TL	5
WQV 70/95/3	192	3 Kutup	1063600000	246,60 TL	5
WQV 95N/120N/2	269	2 Kutup	1826890000	94,65 TL	5
WQV 95N/120N/3	269	3 Kutup	1826900000	131,50 TL	5
WQV 95N/120N/4	269	4 Kutup	1826910000	173,45 TL	5
WQV 120/2	269	2 Kutup	1063300000	183,55 TL	5
WQV 120/3	269	3 Kutup	1063400000	257,10 TL	5

W Serisi Ray Klemensleri - Vida Bağlantı Teknolojisi



ZQV 2.5N/2 GE



ZQV 2.5N/4 GE



ZQV 2.5N/10 GE



QL 4 SAK6N



STB 35 IH/GE



WKS 1/2



VQB 1.5/50 BL

Tip	A	Kutup Sayısı	Sipariş No	Fiyat/Birim	Ambalaj
Vidalı Klemens Tarak Üst Köprü					
ZQV 2.5N/2 GE	24	2 Kutup	1693800000	3,65 TL	60
ZQV 2.5N/3 GE	24	3 Kutup	1693810000	6,35 TL	60
ZQV 2.5N/4 GE	24	4 Kutup	1693820000	9,05 TL	60
ZQV 2.5N/5 GE	24	5 Kutup	1693830000	11,25 TL	20
ZQV 2.5N/6 GE	24	6 Kutup	1693840000	14,20 TL	20
ZQV 2.5N/7 GE	24	7 Kutup	1693850000	16,90 TL	20
ZQV 2.5N/8 GE	24	8 Kutup	1693860000	19,70 TL	20
ZQV 2.5N/9 GE	24	9 Kutup	1693870000	22,40 TL	20
ZQV 2.5N/10 GE	24	10 Kutup	1693880000	25,40 TL	20
ZQV 2.5N/20 GE	24	20 Kutup	1909000000	50,20 TL	20
ZQV 4N/2 GE	32	2 Kutup	1758250000	7,15 TL	60
ZQV 4N/3 GE	32	3 Kutup	1762630000	10,25 TL	60
ZQV 4N/4 GE	32	4 Kutup	1762620000	14,30 TL	60
ZQV 4N/10 GE	32	10 Kutup	1758260000	33,95 TL	20
ZQV 4N/20 GE	32	20 Kutup	1909020000	56,35 TL	20

Tip	A	Kutup Sayısı	Sipariş No	Fiyat/Birim	Ambalaj
WSI 6 Serisi Bara Köprü					
QL 2 SAK6N	24	2 Kutup	0194300000	2,75 TL	50
QL 3 SAK6N	24	3 Kutup	0194400000	3,40 TL	50
QL 4 SAK6N	24	4 Kutup	0194500000	4,10 TL	50
QL 10 SAK6N	24	10 Kutup	0338300000	9,90 TL	20
KISC M3X5	24	Köprü Vidası	1052100000	1,10 TL	100
WAW 2	Klemens Köprü Açma El Aleti		9004510000	743,00 TL	1

Tip	Açıklama	Sipariş No	Fiyat/Birim	Ambalaj
WTL 6/1 Serisi Aksesuar				
STB 25 IH/GE	Test Soketi Girişli Ölçüm Alma Vidası - Sarı	0267200000	15,00 TL	50
BS 25 IH/GE SAKT1	Ayırma Vidası - Sarı	0335700000	7,95 TL	50
STB 35 IH/GE	Test Soketi Girişli Ayırma Vidası - Sarı	0389000000	18,15 TL	50
STB 14/D6/4/M3 SAK10	Ölçüm Kovanı - Vidalı	0169900000	3,30 TL	50
VH 19/6/4.2 SAKT1	Vida Kovanı	0318000000	8,55 TL	50
SSP 3 SAKT1	İzolasyon Kapağı	0531760000	5,55 TL	100
QVS 2 SAKT1+2	Sürgülü Ölçme-Ayırma Köprüsü	0307300000	21,55 TL	20
QB 58/8/9/WI	Tarak Köprü - Kablo Bağlantı Noktasından	0545300000	78,00 TL	10
ISPF QB58 SW	Köprü İzolasyonu	0546000000	12,90 TL	10
WKS 1/2	WTL 6/2 Sürgü Köprü - İki Kutup - 1017700000 için	1604270000	17,15 TL	50

Tip	Kutup Sayısı	Sipariş No	Fiyat/Birim	Ambalaj
MAK / VLI Serisi Klemens Tarak Köprü				
VQB 1.5/50 BL	50 Kutup - Mavi	1633280000	110,00 TL	5
VQB 1.5/50 RT	50 Kutup - Kırmızı	1633290000	91,80 TL	5



WMF 2.5 DI



WMF 2.5



WMF 2.5 FU SW



WMF 2.5 BLZ



WDK 2.5/TR-DU



WDK 2.5/TR-DU-PE



SIHA 3/G20/LD 10-36V

Tip	V / A	Kesit (Yüksüksüz)	Sipariş No	Fiyat/Birim	Ambalaj
WMF Serisi Geçiş Klemensleri					
WMF 2.5	800 / 24	0.5 - 4 mm ² / Geçiş Klemensi	1143070000	12,00 TL	50
WMF 2.5 BL	800 / 24	0.5 - 4 mm ² / Geçiş Klemensi / Mavi	1270040000	12,00 TL	50
WMF 2.5 DI	800 / 24	0.5 - 4 mm ² / Ayırma Klemensi	1143020000	44,00 TL	50
WMF 2.5 DI BL	800 / 24	0.5 - 4 mm ² / Ayırma Klemensi / Mavi	1270070000	44,00 TL	50
WMF 2.5 DI PE	800 / 24	0.5 - 4 mm ² / Ayırma Klemensi / Toprak	1143030000	78,45 TL	50
WMF 2.5 DI PE BL	800 / 24	0.5 - 4 mm ² / Ayırma Klemensi / Toprak / Mavi	1270080000	78,45 TL	50
Ayrma Sistem Sigortalı Klemens					
WMF 2.5 FU SW	250 / 6.3	0.5 - 4 mm ²	1162920000	66,90 TL	50
WMF 2.5 FU 10-36V SW	250 / 6.3	0.5 - 4 mm ² / 10-36V LED	1162930000	103,20 TL	50
WMF 2.5 FU 30-70V SW	250 / 6.3	0.5 - 4 mm ² / 30-70V LED	1162940000	103,70 TL	50
WMF 2.5 FU 60-150V SW	250 / 6.3	0.5 - 4 mm ² / 60-150V LED	1162950000	103,70 TL	50
WMF 2.5 FU 100-250V SW	250 / 6.3	0.5 - 4 mm ² / 100-250V LED	1162960000	103,20 TL	50
WMF 2.5 FU PE SW	250 / 6.3	0.5 - 4 mm ² / İki Kat Alt Toprak	1163040000	98,90 TL	50
WMF 2.5 FU PE 10-36V SW	250 / 6.3	0.5 - 4 mm ² / 10-36V LED / İki Kat Alt Toprak	1163050000	187,40 TL	50
WMF 2.5 FU PE 30-70V SW	250 / 6.3	0.5 - 4 mm ² / 30-70V LED / İki Kat Alt Toprak	1163060000	188,30 TL	50
WMF 2.5 FU PE 60-150V SW	250 / 6.3	0.5 - 4 mm ² / 60-150V LED / İki Kat Alt Toprak	1163070000	188,30 TL	50
WMF 2.5 FU PE 100-250V SW	250 / 6.3	0.5 - 4 mm ² / 100-250V LED / İki Kat Alt Toprak	1163080000	187,85 TL	50
BLZ Bağlantı Noktalı Geçiş ve Sigortalı Klemensler					
WMF 2.5 BLZ	250 / 24	0.5 - 4 mm ² / Geçiş Klemensi	1143050000	20,60 TL	50
WMF 2.5 DI BLZ	250 / 24	0.5 - 4 mm ² / Ayırma Klemensi	1143000000	49,75 TL	50
WMF 2.5 DI BLZ PE	250 / 24	0.5 - 4 mm ² / Ayırma Klemensi / Toprak	1143010000	92,25 TL	50
WMF 2.5 FU BLZ SW	250 / 24	0.5 - 4 mm ²	1162980000	86,00 TL	50
WMF 2.5 FU BLZ 10-36V SW	250 / 24	0.5 - 4 mm ² / 10-36V LED	1162990000	156,25 TL	50
WMF 2.5 FU BLZ 30-70V SW	250 / 24	0.5 - 4 mm ² / 30-70V LED	1163000000	156,25 TL	50
WMF 2.5 FU BLZ 60-150V SW	250 / 24	0.5 - 4 mm ² / 60-150V LED	1163010000	156,25 TL	50
WMF 2.5 FU BLZ 100-250V SW	250 / 24	0.5 - 4 mm ² / 100-250V LED	1163020000	156,25 TL	50
WMF 2.5 FU BLZ PE SW	250 / 24	0.5 - 4 mm ² / İki Kat Alt Toprak	1162820000	119,45 TL	50
WMF 2.5 FU BLZ PE 10-36V SW	250 / 24	0.5 - 4 mm ² / 10-36V LED / İki Kat Alt Toprak	1162830000	208,30 TL	50
WMF 2.5 FU BLZ PE 30-70V SW	250 / 24	0.5 - 4 mm ² / 30-70V LED / İki Kat Alt Toprak	1162840000	208,30 TL	50
WMF 2.5 FU BLZ PE 60-150V SW	250 / 24	0.5 - 4 mm ² / 60-150V LED / İki Kat Alt Toprak	1162850000	208,30 TL	50
WMF 2.5 FU BLZ PE 100-250V SW	250 / 24	0.5 - 4 mm ² / 100-250V LED / İki Kat Alt Toprak	1162860000	208,30 TL	50
İki ve Üç Katlı Ayırma ve Sigorta Sistem Klemensler					
WDK 2.5/TR-DU	690 / 24	0.5 - 2.5 mm ² / Test ayırma / İki Katlı	1247290000	55,90 TL	50
WDK 2.5/TR-DU STB	690 / 24	0.5 - 2.5 mm ² / Test ayırma / Test Soket / İki Katlı	1247310000	63,10 TL	50
WDK 2.5/TR-DU-PE	690 / 24	0.5 - 2.5 mm ² / Test ayırma / Üç Katlı	1247420000	89,85 TL	50
WDK 2.5/TR-DU-PE STB	690 / 24	0.5 - 2.5 mm ² / Test ayırma / Test Soket / Üç Katlı	1247430000	99,35 TL	50
WDK 2.5/TR-DU/o TNHE	690 / 24	0.5 - 4 mm ² / İki Kat / SIHA ve BEST modü	1833600000	49,25 TL	50
WDK 2.5/TR-DU/o TNHE StB	690 / 24	0.5 - 4 mm ² / İki Kat / SIHA ve BEST modü	1833610000	55,90 TL	50
WDK 2.5/TR-DU-PE/o TNHE	690 / 24	0.5 - 4 mm ² / Üç Kat / SIHA ve BEST modül / Toprak	1833640000	79,30 TL	50
SIHA 3/G20	400	Sigorta Modül	7921560000	23,90 TL	25
SIHA 3/G20/LD 10-36V	10 - 36	10-36V AC-DC Led Sigorta Modül	7921570000	52,10 TL	25
SIHA 3/G20/LD 140-250V	140 - 250	140-250V Led Sigorta Modül	7921600000	56,35 TL	25
BEST		Boş Modül	1833100000	39,20 TL	50
BEST/DRBR	400 / 41	Jumper Modül	1878570000	50,20 TL	50
BEST/D	Max 250	WTR 2.5/ 1N4007 diyotlu fiş	1878560000	52,10 TL	50

WMF Serisi Marshalling Ray Klemensleri - Vida Bağlantı Teknolojisi



AP WMF2.5



WAP WDK 2.5N/TR-DU



BLZP 5.08HC/04/90 SN OR BX

Tip	Açıklama	Sipariş No	Fiyat/Birim	Ambalaj
Nihayet Plakası - BLZ Klemensler				
AP WMF2.5	WMF Serisi	1142990000	7,85 TL	50
BLZ Klemensler				
WAP WDK 2.5N/TR-DU	WDK 2.5N/TR-DU Serisi	1839850000	8,10 TL	50
BLZP 5.08HC/02/90 SN OR BX	2 Kutup	1948000000	7,85 TL	180
BLZP 5.08HC/04/90 SN OR BX	4 Kutup	1948020000	15,80 TL	90
BLZP 5.08HC/08/90 SN OR BX	8 Kutup	1948060000	31,10 TL	42
BLZP 5.08HC/12/90 SN OR BX	12 Kutup	1948110000	46,85 TL	30
BLZP 5.08HC/16/90 SN OR BX	16 Kutup	1948150000	62,65 TL	18

Akım, Gerilim ve Test Klemensleri

Akım trafosu test ölçümlerinde, akım trafosu üzerinde empedans oluşabilmektedir.

Bu tip durumlar akım trafosunun zarar görmesine yol açar. Dolayısı ile bu durum bir iş ve mali yük oluşturmaktadır. Weidmüller bir çok geçiş klemensi ile bu tür bağlantılar için uygun çözümler sunmaktadır. WTL Akım, WTD gerilim klemensleri güvenli ölçüm alabileceğiniz yapıda üretilmiştir. Test esnasında sürgü köprü esnekliği ile akım trafosundaki empedansı toprağa aktarabilmektedir.

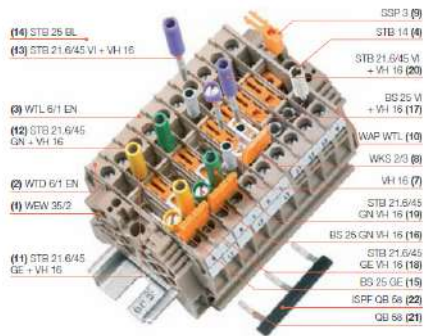

WTL 6/1 EN, WTD 6/1 EN Üç Fazlı Sistem İçin

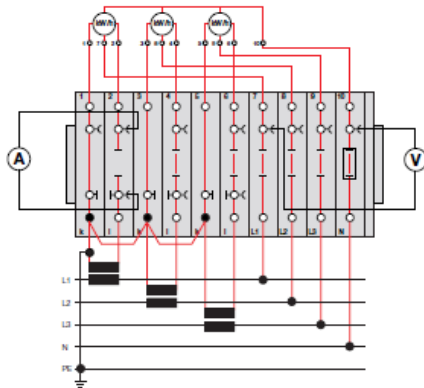

L1 için Örnek Ayırma ve Ölçme Şeması

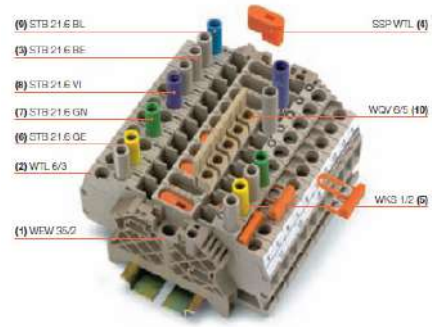

WTL 6/3 Üç Fazlı Sistem İçin

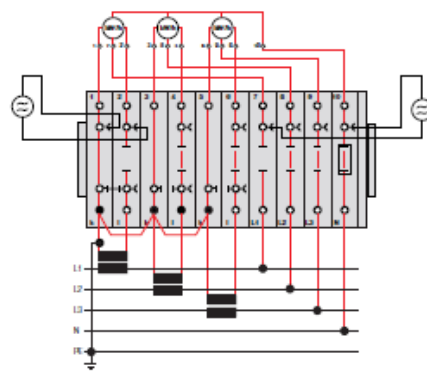

L1 için Harici Güç Kaynağı İle Test Alma

Z Serisi Ray Klemensleri - Yaylı Bağlantı Teknolojisi

0.13 - 35 mm² arası iletkenlerin Z serisi yaylı klemenslere bağlantısı pratik bir şekilde gerçekleştirilir.

Z serisi yay bağlantılı klemensler müşteri istekleri doğrultusunda tasarlanmıştır;

- Küçük Tasarım
- Geniş Markalama Alanları
- Klemensle Bütünleştirilmiş Test Noktaları
- Üst Köprüler Z Serisi ve Diğer Serilerle Kullanılabilir.

Z serisi klemensler oldukça geniş sıkıştırma kesiti aralığına sahiptir ve iki kanal köprüleme yapmaya olanak verir. Bu sayede istenilen sayıda köprüleme yapılabilir.

Aşağıdaki versiyonlarda üretilmişlerdir :

Z-Standart

- 0,05 - 35 mm² arası iletken kesiti
- Tornavida yönünün paralelinde üstten iletken girişi

Z-Installation

- 0,13 - 25 mm² arası iletken kesiti
- 10 x 3 mm nötr barası veya vidasız üstköprü ile bağlantı

Bazı Klemens Tipleri:

- **ZDU** - Geçiş Klemensleri
- **ZPE** - Topraklama Klemensleri
- **ZNT** - Nötr Klemensleri
- **ZDL** - Üç İletkenli Dağıtım Klemensleri
- **ZTR** - Ölçme Ayırma Klemensleri
- **ZSI** - Sigortalı Klemensler
- **ZDK** - Çok Katlı Klemensler

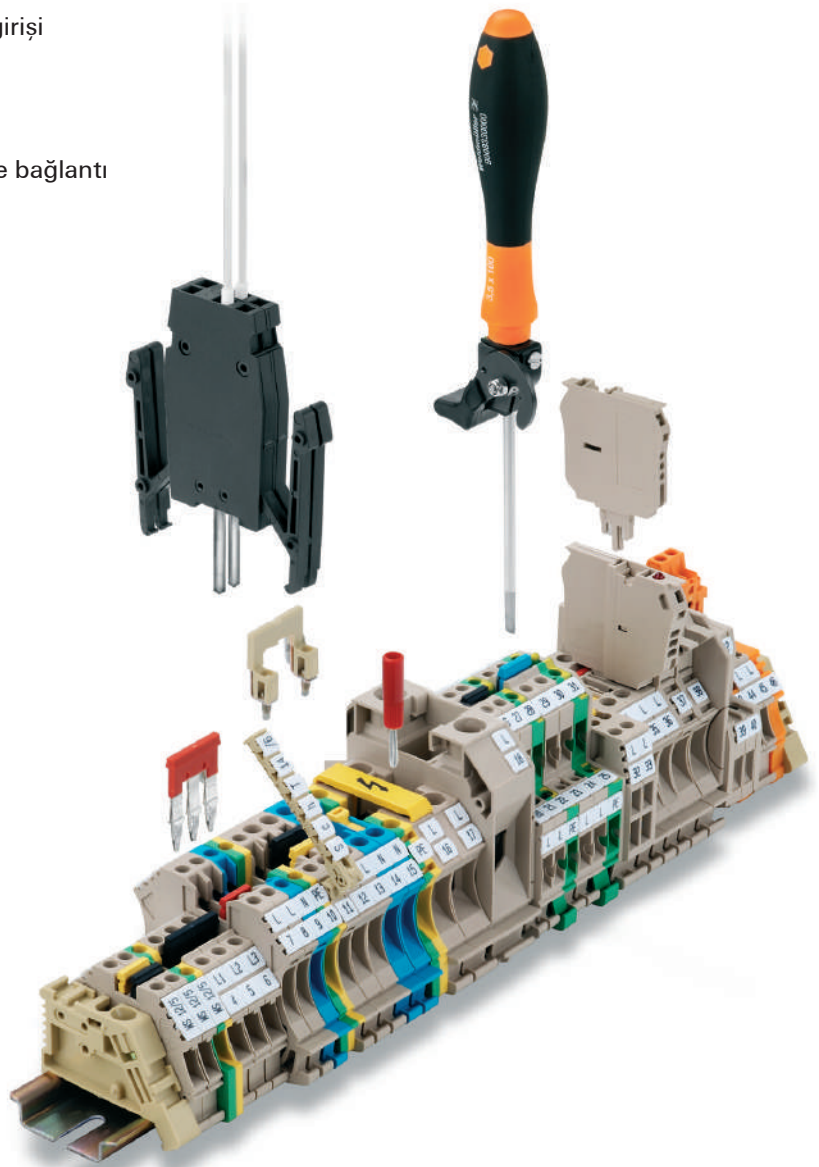

Z Serisi Ray Klemensleri - Yaylı Bağlantı Teknolojisi

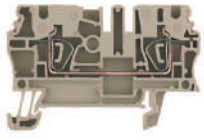

ZDU 2.5



ZDU 2.5 GE



ZDU 2.5 BL



ZDU 35



ZDU 2.5/3AN



ZDK 2.5



ZMAK 2.5

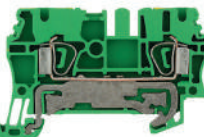

ZPE 2.5

Tip	V / A	Kesit (Yüksüksüz)	Sipariş No	Fiyat/Birim	Ambalaj
Z Serisi Geçiş Klemensleri					
ZDU 2.5	800 / 24	0.5 - 4 mm ²	1608510000	3,90 TL	100
ZDU 2.5 BL	800 / 24	0.5 - 4 mm ²	1608520000	3,90 TL	100
ZDU 1.5	500 / 17.5	0.5 - 1.5 mm ²	1775480000	4,80 TL	100
ZDU 1.5 BL	500 / 17.5	0.5 - 1.5 mm ²	1775490000	4,80 TL	100
ZDU 4	800 / 32	0.5 - 6 mm ²	1632050000	5,25 TL	100
ZDU 4 BL	800 / 32	0.5 - 6 mm ²	1632060000	5,25 TL	100
ZDU 6	800 / 41	1.5 - 10 mm ²	1608620000	8,85 TL	50
ZDU 6 BL	800 / 41	1.5 - 10 mm ²	1608630000	8,85 TL	50
ZDU 10	1000 / 57	1.5 - 16 mm ²	1746750000	12,60 TL	25
ZDU 10 BL	1000 / 57	1.5 - 16 mm ²	1746760000	12,60 TL	25
ZDU 16	1000 / 76	2.5 - 25 mm ²	1745230000	16,65 TL	25
ZDU 16 BL	1000 / 76	2.5 - 25 mm ²	1745240000	16,65 TL	25
ZDU 35	800 / 125	2.5 - 35 mm ²	1739620000	111,85 TL	10
ZDU 35 BL	800 / 125	2.5 - 35 mm ²	1739630000	111,85 TL	10

Renk Tipleri

	Bej	Mavi	Turuncu	Kahverengi	Sarı	Yeşil	Gri	Kırmızı	Siyah	Pembe	Beyaz
ZDU 2.5	160851	160852	163678	168330	168327	168328	168331	168326	168333	168329	168332
ZDU 4	163205	163206	163683	168362	168359	-	168363	168358	168365	-	168364
ZDU 6	160862	160863	163682	-	-	-	-	-	-	-	-
ZDU 10	174675	174676	183061	-	-	-	-	-	-	-	-
ZDU 16	174523	174524	183068	-	-	-	-	-	-	-	-
ZDU 35	173962	173963	183076	-	-	-	-	-	-	-	-

Not: Renkli klemenslerde fiyat farklılıkları bulunmaktadır, bilgi için lütfen fiyat talebinde bulununuz.

Tip	V / A	Kesit (Yüksüksüz)	Sipariş No	Fiyat/Birim	Ambalaj
İkili Geçiş Klemensleri					
ZDU 2.5/3AN	800 / 24	0.5 - 4 mm ²	1608540000	8,35 TL	100
ZDU 2.5/4AN	800 / 24	0.5 - 4 mm ²	1608570000	10,80 TL	100
ZDU 2.5/2X2AN	800 / 24	0.5 - 4 mm ²	1608600000	17,70 TL	100
ZDU 4/3AN	800 / 32	1.5 - 6 mm ²	7904180000	12,00 TL	50
ZDU 4/4AN	800 / 32	1.5 - 6 mm ²	7904290000	14,50 TL	50

İki Katlı Klemensler

ZDK 1.5	500 / 17.5	0.5 - 1.5 mm ²	1791100000	11,25 TL	100
ZDK 1.5DU-PE	500 / 17.5	0.5 - 1.5 mm ²	1791120000	28,20 TL	100
ZDK 2.5	800 / 24	0.5 - 2.5 mm ²	1674300000	13,45 TL	50
ZDK 2.5DU-PE	800 / 24	0.5 - 2.5 mm ²	1689970000	41,05 TL	50
ZDK 6S/L/L	800 / 41	1.5 - 6 mm ²	1733260000	41,05 TL	25

Üç Katlı Klemensler (Her Üç Kat Köprülenebilir)

ZDL 2.5-2N	500 / 20	0.5 - 2.5 mm ²	1782300000	32,55 TL	50
ZDL 2.5-2N/PE/L/L	500 / 20	0.5 - 2.5 mm ²	1131750000	55,90 TL	50
ZDL 2.5-2N/PE/L/N	500 / 20	0.5 - 2.5 mm ²	1131760000	55,90 TL	50
ZDL 2.5-2N PE	500 / 20	0.5 - 2.5 mm ² / Üç Kat Köprülü Toprak	1131740000	62,10 TL	50
ZVLD 2.5	250 / 24	0.5 - 2.5 mm ² / Dört Katlı Klemens	1208920000	59,25 TL	50
ZMAK 2.5	250 / 24	0.5 - 2.5 mm ² / Dört Katlı / 3 Faz - 1 PE	1768000000	59,25 TL	25

Topraklama Klemensleri

ZPE 2.5	800	0.5 - 4 mm ²	1608640000	17,50 TL	100
ZPE 4	800	0.5 - 6 mm ²	1632080000	22,35 TL	100
ZPE 6	800	1.5 - 10 mm ²	1608670000	27,70 TL	50
ZPE 10	800	1.5 - 16 mm ²	1746770000	34,90 TL	25
ZPE 16	800	2.5 - 25 mm ²	1745250000	45,85 TL	25
ZPE 35	800	2.5 - 35 mm ²	1739650000	180,65 TL	10

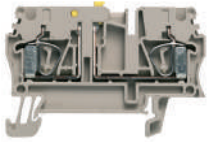

ZTR 2.5

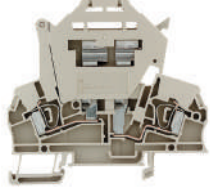

ZSI 2.5



ZSI 2.5-2/2X2AN/G20



ZTR 2.5/0.TNHE



SIHA 3/G20



ZPV 1.5



ZIA 1.5/3L-1S/LD-RT



ZVL 1.5

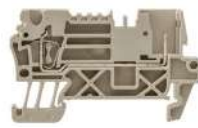

ZT 2.5/2AN/1

Tip	V / A	Kesit (Yüksüksüz)	Sipariş No	Fiyat/Birim	Ambalaj
Ölçme Ayırma Klemensleri					
ZTR 2.5	500 / 20	0.5 - 4 mm ²	1831280000	27,70 TL	100
ZTR 2.5/3AN	500 / 20	0.5 - 4 mm ²	8731720000	25,85 TL	100
ZDTR 2.5	400 / 16	0.5 - 4 mm ² / İki Kat / İki Kat Ayırma	1745400000	76,00 TL	20
ZTD 6	800 / 41	1.5 - 6 mm ² / Direk Besleme	1771810000	44,00 TL	20
ZTD 6/STB	800 / 41	1.5 - 6 mm ² / Direk Besleme / Test Soket	1771960000	40,55 TL	20
ZTL 6	800 / 41	1.5 - 6 mm ² / Sürgü Ayırma	1771800000	45,85 TL	20
ZTL 6/STB	800 / 41	1.5 - 6 mm ² / Sürgü Ayırma / Test Soket	1771950000	64,05 TL	20

Sigortalı Klemensler ve Modüller					
ZSI 2.5	500 / 6.3	0.5 - 4 mm ² / 5X20 Sigorta	1616400000	34,40 TL	50
ZSI 2.5/LD 28AC	... / 6.3	0.5 - 4 mm ² / 5X20 Sigorta / LED	1616440000	82,20 TL	50
ZSI 2.5/LD 60AC	... / 6.3	0.5 - 4 mm ² / 5X20 Sigorta / LED	1616430000	82,20 TL	50
ZSI 2.5/LD 120AC	... / 6.3	0.5 - 4 mm ² / 5X20 Sigorta / LED	1616420000	82,20 TL	50
ZSI 2.5/LD 250AC	... / 6.3	0.5 - 4 mm ² / 5X20 Sigorta / LED	1616410000	82,20 TL	50
ZSI 2.5/5X25	500 / 6.3	0.5 - 4 mm ² / 5X25 Sigorta	1730900000	36,80 TL	50
ZSI 2.5-2/2X2AN/G20	500 / 27	0.5 - 4 mm ² / 5X25 Sigorta / Hazardous Bölge	1826050000	64,05 TL	20
ZSI 6-2 2X2.5/G20	690 / 24	0.5 - 4 mm ² / 5X25 Sigorta / Hazardous Bölge	1820930000	64,05 TL	20
ZSI 2.5-2/2X2AN/G20/GL	690 / 24	0.5 - 4 mm ² / 5X25 Sigorta / Hazardous Bölge / Led	1826030000	104,65 TL	20
ZSI 6-2 2X2.5/G20/GL	690 / 24	0.5 - 4 mm ² / 5X25 Sigorta / Hazardous Bölge / Led	1820860000	104,65 TL	20
ZSI 6-2/FC	250 / 30	0.5 - 10 mm ² / Oto Sigorta Tip Klemens	1814690000	81,75 TL	25
ZSI 6-2/FC LD	250 / 30	0.5 - 10 mm ² / Oto Sigorta Tip Klemens / Led	1814700000	110,90 TL	25
ZTR 2.5/0.TNHE	500 / 20	SIHA ve BEST modül için	1831130000	24,35 TL	100
ZDL 2.5/SI/DU	500 / 20	SIHA ve BEST modül için / İki Katlı / Üst Kat Sigortalı	1763180000	64,05 TL	25
SIHA 3/G20	400	Sigorta Modül	7921560000	23,90 TL	25
SIHA 3/G20/LD 10-36V	10 - 36	10-36V AC-DC Led Sigorta Modül	7921570000	52,10 TL	25
SIHA 3/G20/LD 140-250V	140 - 250	140-250V Led Sigorta Modül	7921600000	56,35 TL	25
BEST		Boş Modül	1833100000	39,20 TL	50
BEST/DRBR	400 / 41	Jumper Modül	1878570000	50,20 TL	50
BEST/D	Max 250	WTR 2.5/ 1N4007 diyotlu fiş	1878560000	52,10 TL	50

Sigortalar					
G 20/0.25A/F	0.25	Sigorta	0430500000	9,00 TL	10
G 20/0.50A/F	0.5	Sigorta	0430600000	9,00 TL	10
G 20/1.00A/F	1	Sigorta	0430700000	9,00 TL	10
G 20/2.00A/F	2	Sigorta	0430900000	9,00 TL	10

Sensör - Aktüatörler için Köprü Gerektirmeyen Modüler Yaylı Klemensler					
ZPV 1.5	250 / 17.5	Dört Bölüm Boş Taban	1676630000	7,00 TL	100
ZIA 1.5/3L-1S	250 / 17.5	0.5 - 2.5 mm ² / İki Bölüm / İkilili Geçiş	1651980000	15,30 TL	100
ZIA 1.5/3L-1S/LD-RT	250 / 17.5	0.5 - 2.5 mm ² / İki Bölüm / İkilili Geçiş / Led	1651990000	46,85 TL	50
ZIA 1.5/3L-PE	250 / 17.5	0.5 - 2.5 mm ² / İki Bölüm / Toprak	1652000000	69,75 TL	20
ZIA 1.5/4L-1S	250 / 17.5	0.5 - 2.5 mm ² / Üç Bölüm / İkilili Geçiş	1652010000	16,25 TL	100
ZIA 1.5/4L-1S/LD	250 / 17.5	0.5 - 2.5 mm ² / Üç Bölüm / İkilili Geçiş / Led	1652020000	36,80 TL	50
ZIA 1.5/4L-PE	250 / 17.5	0.5 - 2.5 mm ² / Üç Bölüm / Toprak	1652030000	69,75 TL	20
ZVL 1.5	250 / 17.5	0.5 - 2.5 mm ² / Dağıtım Klemens	1649300000	7,00 TL	100
ZVL 1.5 BL	250 / 17.5	0.5 - 2.5 mm ² / Dağıtım Klemens / Mavi	1650360000	8,35 TL	100
ZVL 1.5 BR	250 / 17.5	0.5 - 2.5 mm ² / Dağıtım Klemens / Kahverengi	1650370000	8,35 TL	100
ZVL 1.5 O.QV	250 / 17.5	0.5 - 2.5 mm ² / Dağıtım Klemens	1711930000	8,55 TL	100
ZVL 1.5/PE GN/GE BED	250 / 17.5	0.5 - 2.5 mm ² / Dağıtım Klemens / Toprak	1651970000	8,35 TL	100

WeiCoS Sistemi Klemens Çözümleri / Geçiş Taban Modül					
ZT 2.5/2AN/1	500 / 24	0.5 - 4 mm ² / 1 Yay - 1 Soket Bağlantı	1815070000	9,40 TL	50
ZT 2.5/3AN/1	500 / 24	0.5 - 4 mm ² / 2 Yay - 1 Soket Bağlantı	1815090000	13,35 TL	50

Serinin devamı sayfa 14

Z Serisi Ray Klemensleri - Yaylı Bağlantı Teknolojisi



ZTPE 2.5/2AN/1



ZTPE 2.5/4AN/2



ZDT 2.5/2



ZP 2.5/1AN/1



ZP 2.5/1AN/10



ZEW 35

Tip	V / A	Kesit (Yüksüksüz)	Sipariş No	Fiyat/Birim	Ambalaj
ZT 2.5/4AN/2	500 / 24	0.5 - 4 mm ² / 2 Yay - 2 Soket Bağlantı	1815110000	15,80 TL	50
ZT 2.5/4AN/4	500 / 24	0.5 - 4 mm ² / 4 Soket Bağlantı	1815130000	13,35 TL	50
ZT 4/2AN/1	800 / 32	0.5 - 6 mm ² / 1 Yay - 1 Soket Bağlantı	1854960000	14,05 TL	50
ZT 4/4AN/2	800 / 32	0.5 - 6 mm ² / 2 Yay - 2 Soket Bağlantı	1848350000	22,95 TL	50

WeiCoS Sistemi Klemens Çözümleri / Toprak Taban Modül

ZTPE 2.5/2AN/1	500	0.5 - 4 mm ² / 1 Yay - 1 Soket Bağlantı	1815080000	17,40 TL	50
ZTPE 2.5/3AN/1	500	0.5 - 4 mm ² / 2 Yay - 1 Soket Bağlantı	1815100000	22,95 TL	50
ZTPE 2.5/4AN/2	500	0.5 - 4 mm ² / 2 Yay - 2 Soket Bağlantı	1815120000	24,35 TL	50
ZTPE 2.5/4AN/4	500	0.5 - 4 mm ² / 4 Soket Bağlantı	1815140000	22,95 TL	50
ZTPE 4/2AN/1	800	0.5 - 6 mm ² / 1 Yay - 1 Soket Bağlantı	1854970000	24,35 TL	50
ZTPE 4/4AN/2	800	0.5 - 6 mm ² / 2 Yay - 2 Soket Bağlantı	1848330000	39,70 TL	50

WeiCoS Sistemi Klemens Çözümleri / İki Katlı ve Ayrırma Taban Modül

ZDT 2.5/2	500 / 24	0.5 - 4 mm ² / Her Kat 1 Yay - 1 Soket Bağlantı	1815150000	22,95 TL	50
ZDT 2.5/2 DU-PE	500 / 24	0.5 - 4 mm ² / Her Kat 1 Yay - 1 Soket Bağlantı / Alt Toprak	1815160000	34,90 TL	50
ZTTR 2.5	400 / 16	0.5 - 4 mm ² / 2 Yay - 1 Soket Bağlantı / Ayrırma	1865510000	21,95 TL	50
ZTTR 2.5 0.TNHE	400 / 16	0.5 - 4 mm ² / 2 Yay - 1 Soket Bağlantı / SIHA - BEST	1905470000	20,60 TL	50

WeiCoS Sistemi Klemens Çözümleri Soketler

ZP 2.5/1AN/1	500 / 24	0.5 - 4 mm ² / 1 Kutup	1815430000	10,65 TL	50
ZP 2.5/1AN/2	500 / 24	0.5 - 4 mm ² / 2 Kutup	1815440000	18,65 TL	25
ZP 2.5/1AN/3	500 / 24	0.5 - 4 mm ² / 3 Kutup	1815450000	27,20 TL	25
ZP 2.5/1AN/4	500 / 24	0.5 - 4 mm ² / 4 Kutup	1815500000	34,90 TL	25
ZP 2.5/1AN/5	500 / 24	0.5 - 4 mm ² / 5 Kutup	1815510000	35,90 TL	25
ZP 2.5/1AN/6	500 / 24	0.5 - 4 mm ² / 6 Kutup	1815520000	39,20 TL	25
ZP 2.5/1AN/7	500 / 24	0.5 - 4 mm ² / 7 Kutup	1815530000	45,35 TL	25
ZP 2.5/1AN/8	500 / 24	0.5 - 4 mm ² / 8 Kutup	1815540000	51,10 TL	20
ZP 2.5/1AN/9	500 / 24	0.5 - 4 mm ² / 9 Kutup	1815550000	57,40 TL	20
ZP 2.5/1AN/10	500 / 24	0.5 - 4 mm ² / 10 Kutup	1815560000	80,75 TL	20
ZP 2.5/1AN/11	500 / 24	0.5 - 4 mm ² / 11 Kutup	1815570000	82,70 TL	20
ZP 2.5/1AN/12	500 / 24	0.5 - 4 mm ² / 12 Kutup	1815580000	83,15 TL	20
ZP 2.5/1AN/13	500 / 24	0.5 - 4 mm ² / 13 Kutup	1815590000	84,10 TL	10
ZP 2.5/1AN/14	500 / 24	0.5 - 4 mm ² / 14 Kutup	1815600000	88,40 TL	10
ZP 2.5/1AN/15	500 / 24	0.5 - 4 mm ² / 15 Kutup	1815610000	94,65 TL	10
ZP 2.5/1AN/16	500 / 24	0.5 - 4 mm ² / 16 Kutup	1815620000	100,85 TL	10
ZP 2.5/1AN/17	500 / 24	0.5 - 4 mm ² / 17 Kutup	1815180000	108,95 TL	10
ZP 2.5/1AN/QV/1	500 / 24	0.5 - 4 mm ² / 1 Kutup / Köprülenebilir	1815190000	11,45 TL	50
ZP 2.5/1AN/QV/2	500 / 24	0.5 - 4 mm ² / 2 Kutup / Köprülenebilir	1815200000	20,60 TL	25
ZP 2.5/1AN/QV/3	500 / 24	0.5 - 4 mm ² / 3 Kutup / Köprülenebilir	1815210000	27,20 TL	25
ZP 2.5/1AN/QV/4	500 / 24	0.5 - 4 mm ² / 4 Kutup / Köprülenebilir	1815220000	36,30 TL	25
ZP 2.5/1AN/QV/10	500 / 24	0.5 - 4 mm ² / 10 Kutup / Köprülenebilir	1815280000	80,75 TL	20
ZP 4/1AN/1	800 / 32	0.5 - 6 mm ² / 1 Kutup	1848340000	18,95 TL	50
ZP 4/1AN/2	800 / 32	0.5 - 6 mm ² / 2 Kutup	1854990000	32,00 TL	25
ZP 4/1AN/3	800 / 32	0.5 - 6 mm ² / 3 Kutup	1855000000	42,50 TL	25
ZP 4/1AN/4	800 / 32	0.5 - 6 mm ² / 4 Kutup	1855010000	55,40 TL	25
ZP 4/1AN/10	800 / 32	0.5 - 6 mm ² / 10 Kutup	1855070000	141,90 TL	10

Tip	Açıklama	Sipariş No	Fiyat/Birim	Ambalaj
Klemens Durdurucuları				
ZEW 35	Vidasız Tip 6mm Kalınlık	9540000000	4,50 TL	20
ZEW 35/2	Vidasız Tip 8mm Kalınlık	8630740000	5,20 TL	20
ZEW 35/2 SW	Vidasız Tip 8mm Kalınlık Siyah	1162610000	5,75 TL	20



ZAP/TW 1



ZAP/TW ZDU1.5/2AN



ZAP/TW 3



ZQV 1.5/2



ZQV 1.5/4



ZQV 2.5/2



ZQV 2.5/4



ZQV 2.5/20

Tip	Açıklama	Sipariş No	Fiyat/Birim	Ambalaj
Nihayet Plakaları				
ZAP/TW 1	ZDU 2.5	1608740000	3,60 TL	50
ZAP/TW 1 BL	ZDU 2.5 Mavi Serisi	1608750000	3,60 TL	50
ZAP/TW ZDU1.5/2AN	ZDU 1.5 Serisi	1776030000	3,25 TL	20
ZAP/TW ZDU1.5/2AN BL	ZDU 1.5 Mavi Serisi	1776040000	3,25 TL	20
ZAP/TW 4	ZDU 4 Serisi	1632090000	3,60 TL	50
ZAP/TW 4 BL	ZDU 4 Mavi Serisi	1632100000	3,60 TL	50
ZAP/TW 5	ZDU 6 Serisi	1608830000	3,60 TL	50
ZAP/TW 5 BL	ZDU 6 Mavi Serisi	1608840000	3,60 TL	50
ZAP/TW ZDU10	ZDU 10 Serisi	1748660000	4,05 TL	20
ZAP/TW ZDU10 BL	ZDU 10 Mavi Serisi	1764110000	3,90 TL	20
ZAP/TW ZDU16	ZDU 16 Serisi	1745150000	5,75 TL	20
ZAP/TW ZDU16 BL	ZDU 16 Mavi Serisi	1764100000	5,75 TL	20
ZAP/TW ZDK1.5	ZDK 1.5 Serisi	1791160000	3,65 TL	20
ZAP/TW ZDK2.5	ZDK 2.5 Serisi	1674730000	7,45 TL	20
ZAP/TW ZDK2.5 BL	ZDK 2.5 Mavi Serisi	1748800000	6,20 TL	20
ZAP/TW ZDL2.5-2N	ZDL 2.5 Serisi	1782340000	5,75 TL	20
ZAP ZVLD 2.5	ZVLD 2.5 Serisi	1210410000	5,55 TL	10
ZAP ZMAK2.5	ZMAK 2.5 Serisi	1768010000	9,05 TL	10
ZAP/TW 2 DB	ZTR 2.5 - ZDU 2.5/3 AN Serisi	1608770000	4,05 TL	50
ZAP/TW 3	ZSI 2.5 - ZDU 2.5/4 AN Serisi	1608800000	4,05 TL	50
ZAP/TW 4/3AN	ZDU 4/3AN Serisi	7904100000	5,55 TL	20
ZAP/TW4/4AN	ZDU 4/4AN Serisi	7904210000	5,55 TL	20
ZAP TNHE/ZSI2.5	ZSI 2.5 Serisi Sigorta Kapağı	1610840000	3,40 TL	25
ZAP ZDL2.5	ZDL 2.5 Serisi	1720910000	6,35 TL	20
ZTW ZTL6	ZTL 6 Serisi	1771870000	10,05 TL	20
ZAP/TW ZPV1.5	ZPV 1.5 Serisi	1674650000	4,95 TL	50
ZAP/TW ZIA1.5/3L	ZIA 1.5/3L Serisi	1649540000	5,75 TL	50
ZAP/TW ZIA1.5/4L	ZIA 1.5/4L Serisi	1649550000	5,75 TL	50
ZAP/TW ZT2.5/2AN	ZT 2.5/2AN Serisi	1816030000	3,25 TL	50
ZAP/TW ZT2.5/3AN	ZT 2.5/3AN Serisi	1816050000	3,25 TL	50
ZAP/TW ZT2.5/4AN/2	ZT 2.5/4AN/2 Serisi	1816070000	4,30 TL	50
ZAP/TW ZT2.5/4AN/4	ZT 2.5/4AN/4 Serisi	1816090000	4,30 TL	50

Tip	A	Kutup Sayısı	Sipariş No	Fiyat/Birim	Ambalaj
Z Serisi Klemens Üst Köprü					
ZQV 1.5/2	17.5	2 Kutup / ZDU 1.5 - ZDK 1.5 - ZEI 6 Seri	1776120000	3,40 TL	60
ZQV 1.5/3	17.5	3 Kutup / ZDU 1.5 - ZDK 1.5 - ZEI 6 Seri	1776130000	6,75 TL	60
ZQV 1.5/4	17.5	4 Kutup / ZDU 1.5 - ZDK 1.5 - ZEI 6 Seri	1776140000	9,05 TL	60
ZQV 1.5/5	17.5	5 Kutup / ZDU 1.5 - ZDK 1.5 - ZEI 6 Seri	1776150000	11,45 TL	20
ZQV 1.5/10	17.5	10 Kutup / ZDU 1.5 - ZDK 1.5 - ZEI 6 Seri	1776200000	29,15 TL	20
ZQV 2.5/2	24	2 Kutup / ZDU 2.5 - ZDK 2.5 - ZTR 2.5 Seri	1608860000	3,25 TL	60
ZQV 2.5/3	24	3 Kutup / ZDU 2.5 - ZDK 2.5 - ZTR 2.5 Seri	1608870000	5,80 TL	60
ZQV 2.5/4	24	4 Kutup / ZDU 2.5 - ZDK 2.5 - ZTR 2.5 Seri	1608880000	7,95 TL	60
ZQV 2.5/5	24	5 Kutup / ZDU 2.5 - ZDK 2.5 - ZTR 2.5 Seri	1608890000	11,45 TL	20
ZQV 2.5/6	24	6 Kutup / ZDU 2.5 - ZDK 2.5 - ZTR 2.5 Seri	1608900000	14,30 TL	20
ZQV 2.5/7	24	7 Kutup / ZDU 2.5 - ZDK 2.5 - ZTR 2.5 Seri	1608910000	16,90 TL	20
ZQV 2.5/8	24	8 Kutup / ZDU 2.5 - ZDK 2.5 - ZTR 2.5 Seri	1608920000	19,55 TL	20
ZQV 2.5/9	24	9 Kutup / ZDU 2.5 - ZDK 2.5 - ZTR 2.5 Seri	1608930000	22,40 TL	20
ZQV 2.5/10	24	10 Kutup / ZDU 2.5 - ZDK 2.5 - ZTR 2.5 Seri	1608940000	22,80 TL	20
ZQV 2.5/20	24	20 Kutup / ZDU 2.5 - ZDK 2.5 - ZTR 2.5 Seri	1908960000	53,05 TL	20
ZQV 4/2 GE	32	2 Kutup / ZDU 4 - ZDK 4/S - ZEI 6 Seri	1608950000	3,65 TL	60

Serinin devamı sayfa 16

Z Serisi Ray Klemensleri - Yaylı Bağlantı Teknolojisi



ZQV 2.5N/2 GE



ZQV 2.5N/4 GE



ZQV 2.5N/10 GE

Tip	A	Kutup Sayısı	Sipariş No	Fiyat/Birim	Ambalaj
ZQV 4/3 GE	32	3 Kutup / ZDU 4 - ZDK 4/S - ZEI 6 Seri	1608960000	6,35 TL	60
ZQV 4/4 GE	32	4 Kutup / ZDU 4 - ZDK 4/S - ZEI 6 Seri	1608970000	8,15 TL	60
ZQV 4/5 GE	32	5 Kutup / ZDU 4 - ZDK 4/S - ZEI 6 Seri	1608980000	12,10 TL	20
ZQV 4/6 GE	32	6 Kutup / ZDU 4 - ZDK 4/S - ZEI 6 Seri	1608990000	15,30 TL	20
ZQV 4/7 GE	32	7 Kutup / ZDU 4 - ZDK 4/S - ZEI 6 Seri	1609000000	18,15 TL	20
ZQV 4/8 GE	32	8 Kutup / ZDU 4 - ZDK 4/S - ZEI 6 Seri	1609010000	21,05 TL	20
ZQV 4/9 GE	32	9 Kutup / ZDU 4 - ZDK 4/S - ZEI 6 Seri	1609020000	24,35 TL	20
ZQV 4/10 GE	32	10 Kutup / ZDU 4 - ZDK 4/S - ZEI 6 Seri	1609030000	25,40 TL	20
ZQV 4/20 GE	32	20 Kutup / ZDU 4 - ZDK 4/S - ZEI 6 Seri	1909010000	56,35 TL	20
ZQV 6/2 GE	41	2 Kutup / ZDU 6 - ZDK 6/S - ZTL 6 Seri	1627850000	5,80 TL	60
ZQV 6/3 GE	41	3 Kutup / ZDU 6 - ZDK 6/S - ZTL 6 Seri	1627860000	10,55 TL	60
ZQV 6/4 GE	41	4 Kutup / ZDU 6 - ZDK 6/S - ZTL 6 Seri	1627870000	16,90 TL	60
ZQV 6/24 GE	41	24 Kutup / ZDU 6 - ZDK 6/S - ZTL 6 Seri	1908990000	77,40 TL	10
ZQV 10/2	57	2 Kutup / ZDU 10 Seri	1739680000	10,55 TL	25
ZQV 16/2	76	2 Kutup / ZDU 16 - ZPE 16 Seri	1739690000	11,00 TL	25
ZQV 35/2	125	2 Kutup / ZDU 35 - ZPE 35 Seri	1739700000	14,30 TL	10
ZQV 2.5N/2 GE	24	2 Kutup	1693800000	3,65 TL	60
ZQV 2.5N/3 GE	24	3 Kutup	1693810000	6,35 TL	60
ZQV 2.5N/4 GE	24	4 Kutup	1693820000	9,05 TL	60
ZQV 2.5N/5 GE	24	5 Kutup	1693830000	11,25 TL	20
ZQV 2.5N/6 GE	24	6 Kutup	1693840000	14,20 TL	20
ZQV 2.5N/7 GE	24	7 Kutup	1693850000	16,90 TL	20
ZQV 2.5N/8 GE	24	8 Kutup	1693860000	19,70 TL	20
ZQV 2.5N/9 GE	24	9 Kutup	1693870000	22,40 TL	20
ZQV 2.5N/10 GE	24	10 Kutup	1693880000	25,40 TL	20
ZVQ 2.5/1.5	24	ZDK 2,5 ve ZDLD için iki kat arası köprü	1720700000	6,35 TL	50

Klippon Connect PUSH-IN Klemens Serisi

Klippon® Connect'in size tüm pano yapım aşamalarında sunabileceği avantajları keşfedin.

Özel tasarlanmış işlevsel modüller ve PUSH IN teknolojisi sadece daha kısa planlama ve kurulum süreleri sağlamakla kalmaz, aynı zamanda Weidmüller Configurator ile sizlere dijital pano planlaması için gerekli ideal yazılım arayüzünü de sunar. Ayrıca entegre test noktası gibi ürün özellikleri, işletim sırasında verimliliği artırmaya somut bir şekilde yardımcı olur.

Size olağanüstü avantajlar sunabilmek için ürünlerimizi en küçük ayrıntılarına kadar titizlikle tasarladık. Bu nedenle A-Serisi Klippon® Connect kelemens bloklarımız benzerlerinden bir dizi önemli noktada ayrılarak öne çıkıyor. Yepyeni bir kazanımı ayrıntılı olarak inceleyin ve geniş kullanım avantajlarını keşfedin.

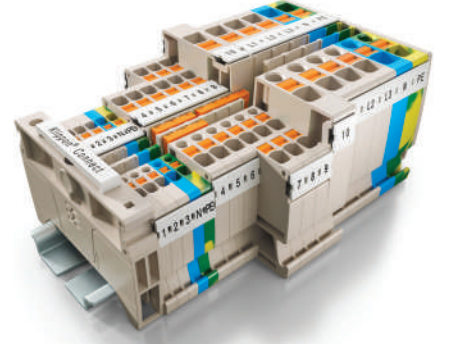
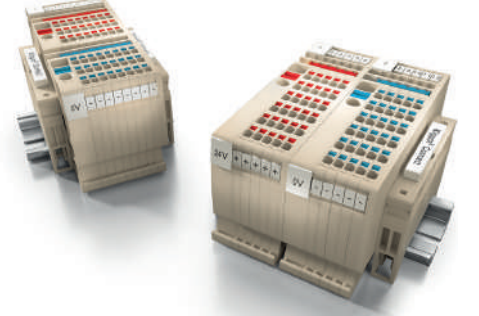

- Push-in bağlantı teknolojisi
- Kurulum için harcanan zamandan %50'ye varan oranda tasarruf
- Basit modifikasyon ve uzatma
- Daha hızlı bakım çalışması

PUSH IN teknolojisine sahip universal klemens bloklarımız kullanıcılarına üretim sürelerini minimize ederek maksimum kazanç sağlamayı garanti eder. Sistem modifikasyonları veya genişlemeler gibi yeniden kablolama gerektiren durumlarda el aleti kullanmaksızın montaj imkanı sunar. Push-in bağlantı teknolojisinin sunduğu yaylı tutunma sistemi sayesinde vibrasyonlara karşı stabil bir yapı oluşturulur ve maksimum ölçüde bağlantı güvenliği sağlanmış olur.



Klippon Connect PUSH IN Klemens Serisi



A2C 2.5

Tip	V / A	Kesit (Yüksüksüz)	Sipariş No	Fiyat/Birim	Ambalaj
Geçiş Klemensleri					
A2C 1.5	500/17.5	1.5 mm ²	1552790000	6,15 TL	100
A2C 1.5 BL	500/17.5	1.5 mm ²	1552820000	6,15 TL	100
A2C 2.5	800/24	2.5 mm ²	1521850000	4,45 TL	100
A2C 2.5 BL	800/24	2.5 mm ²	1521880000	4,45 TL	100
A2C 4	800/32	4 mm ²	2051180000	7,45 TL	100
A2C 4 BL	800/32	4 mm ²	2051210000	7,45 TL	100
A2C 6	800/41	6 mm ²	1992110000	10,25 TL	50
A2C 6 BL	800/41	6 mm ²	1991790000	10,25 TL	50
ALO 6	800/41	6 mm ²	1991780000	24,75 TL	20
ALO 6 BL	800/41	6 mm ²	2065120000	24,75 TL	20
A2C 10	1000/57	10 mm ²	2490360000	19,45 TL	25
A2C 10 BL	1000/57	10 mm ²	2490370000	19,45 TL	25

Renk Tipleri

Bej	Mavi	Turuncu	Kahverengi	Sarı	Yeşil	Gri	Kırmızı	Siyah	Lacivert	Beyaz

A2C 2.5	152185	152188	152193	250803	152194	152195	200311	152190	152198	250800	152197
A2C 4	205118	205121	205123	253437	205125	205126	205133	205122	205131	253438	205129
A2C 6	199211	199179	199180	-	-	-	-	-	-	-	-

Not: Renkli klemenslerde fiyat farklılıkları bulunmaktadır, bilgi için lütfen fiyat talebinde bulununuz.



A3C 2.5

Tip	V / A	Kesit (Yüksüksüz)	Sipariş No	Fiyat/Birim	Ambalaj
İkili Geçiş Klemensleri					
A4C 1.5	500/17.5	1.5 mm ²	1552690000	8,65 TL	100
A4C 1.5 BL	500/17.5	1.5 mm ²	1552700000	8,65 TL	100
A3C 2.5	800/24	2.5 mm ²	1521740000	8,90 TL	100
A3C 2.5 BL	800/24	2.5 mm ²	1521780000	8,90 TL	100
A4C 2.5	800/24	2.5 mm ²	1521690000	11,75 TL	100
A4C 2.5 BL	800/24	2.5 mm ²	1521700000	11,75 TL	100
A3C 4	800/32	4 mm ²	2051240000	14,90 TL	50
A3C 4 BL	800/32	4 mm ²	2051280000	14,90 TL	50
A4C 4	800/32	4 mm ²	2051500000	14,25 TL	50
A4C 4 BL	800/32	4 mm ²	2051520000	14,25 TL	50
A3C 6	800/41	6 mm ²	1991820000	20,00 TL	50
A3C 6 BL	800/41	6 mm ²	1991830000	20,00 TL	50
A3C 10	1000/57	10 mm ²	2490520000	30,65 TL	25
A3C 10 BL	1000/57	10 mm ²	2490510000	30,65 TL	25



A3C 6 BL

İki Katlı Klemensler

A2T 1.5	500/17.5	1.5 mm ²	2469370000	12,80 TL	50
A2T 1.5 BL	500/17.5	1.5 mm ²	2471430000	12,80 TL	50
A2T 1.5 FT-PE	500/17.5	1.5 mm ²	2469390000	29,45 TL	50
A2T 1.5 OR	500/17.5	1.5 mm ²	2471440000	12,80 TL	50
A2T 1.5 PE	500/	1.5 mm ²	2469410000	45,35 TL	50
A2T 1.5 VL	500/17.5	1.5 mm ²	2469400000	28,75 TL	50
A2T 1.5 VL BL	500/17.5	1.5 mm ²	2471450000	28,75 TL	50
A2T 1.5 VL OR	500/17.5	1.5 mm ²	2471460000	28,75 TL	50
A2T 2.5	800/24	2.5 mm ²	1547610000	12,80 TL	50
A2T 2.5 BL	800/24	2.5 mm ²	1547620000	22,20 TL	50
A2T 2.5 VL	800/24	2.5 mm ²	1547650000	26,45 TL	50
A2T 2.5 FT-PE	800/24	2.5 mm ²	1547640000	44,95 TL	50
A2T 2.5 PE	800/8	2.5 mm ²	1547680000	56,35 TL	50



A2T 2.5



A3T 2.5



AMC 2.5



A2C 2.5 PE



ADT 2.5 2C



AFS 2.5 CF 2C BK

Tip	V / A	Kesit (Yüksüksüz)	Sipariş No	Fiyat/Birim	Ambalaj
Üç Katlı Klemensler					
A3T 2.5	800/24	2.5 mm ²	2428510000	35,25 TL	50
A3T 2.5 BL	800/24	2.5 mm ²	2428520000	35,25 TL	50
A3T 2.5 VL	800/24	2.5 mm ²	2428540000	57,90 TL	25
A3T 2.5 FT-FT-PE	800/24	2.5 mm ²	2428530000	57,90 TL	50
A3T 2.5 N-FT-PE	800/24	2.5 mm ²	2428840000	57,90 TL	50
A3T 2.5 PE	800/8	2.5 mm ²	2428550000	73,25 TL	50
Dört Katlı Klemensler					
AMC 2.5	690/21	2.5 mm ²	2434340000	61,50 TL	50
AMC 2.5 800 V	800/21	2.5 mm ²	2434370000	67,90 TL	50
Topraklama Klemensleri					
A2C 1.5 PE	500/6	1.5 mm ²	1552680000	21,95 TL	50
A2C 2.5 PE	800/8	2.5 mm ²	1521680000	16,90 TL	50
A2C 4 PE	800/8	4 mm ²	2051360000	20,80 TL	50
A2C 6 PE	800/8	6 mm ²	1991810000	30,25 TL	50
A2C 10 PE	1000/	10 mm ²	2490440000	42,45 TL	25
A3C 1.5 PE	500/6	1.5 mm ²	1552670000	35,35 TL	50
A4C 1.5 PE	500/6	1.5 mm ²	1552660000	29,25 TL	50
A3C 2.5 PE	800/8	2.5 mm ²	1521670000	29,00 TL	50
A4C 2.5 PE	800/8	2.5 mm ²	1521540000	35,35 TL	50
A3C 4 PE	800/8	4 mm ²	2051410000	39,20 TL	50
A4C 4 PE	800/8	4 mm ²	2051560000	39,20 TL	50
A3C 6 PE	800/8	6 mm ²	1991850000	47,25 TL	50
A2C 2.5 PE /DT/FS	400/6		1989890000	24,85 TL	50
A3C 10 PE	1000/	10 mm ²	2490590000	61,90 TL	25
Ölçme Ayırma Klemensleri					
ADT 2.5 2C	400/20	2.5 mm ²	1989800000	23,50 TL	50
ADT 2.5 2C W/O DTLV	400/20	2.5 mm ²	1989930000	21,05 TL	50
A2C 2.5 /DT/FS	400/20	2.5 mm ²	1989900000	10,55 TL	100
ADT 2.5 3C	400/20	2.5 mm ²	1989830000	24,85 TL	50
ADT 2.5 3C W/O DTLV	400/20	2.5 mm ²	1989940000	23,75 TL	50
ADT 2.5 4C	400/20	2.5 mm ²	1989860000	28,50 TL	50
ADT 2.5 4C W/O DTLV	400/20	2.5 mm ²	1989950000	27,15 TL	50
ADT 4 2C	400/20	4 mm ²	2429850000	34,40 TL	50
ADT 4 2C BL	400/20	4 mm ²	2429880000	34,40 TL	50
ADT 4 2C OR	400/20	4 mm ²	2429890000	34,40 TL	50
Sigortalı Klemensleri					
AFS 2.5 CF 2C BK	400/10	2.5 mm ²	2466530000	27,70 TL	50
AFS 2.5 CF 2C 12V BK	400/10	2.5 mm ²	2466610000	64,05 TL	50
AFS 4 2C BK	250/6.3	4 mm ²	2429860000	43,20 TL	50
AFS 4 2C BK/BL	250/6.3	4 mm ²	2548140000	36,40 TL	50
AFS 4 2C 10-36V BK	250/6.3	4 mm ²	2429870000	103,60 TL	50
AFS 4 2C 30-70V BK	250/6.3	4 mm ²	2434350000	103,60 TL	50
AFS 4 2C 60-150V BK	250/6.3	4 mm ²	2434380000	103,60 TL	50
AFS 4 2C 100-250V BK	250/6.3	4 mm ²	2434390000	103,60 TL	50
Soket Bağlantılı Klemens Grupları					
APGTB 1.5 FT 2C/1	500/17.5	1.5 mm ²	2482160000	6,60 TL	50
APGTB 1.5 FT 2C/1 BL	500/17.5	1.5 mm ²	2482170000	6,60 TL	50
APGTB 1.5 PE 2C/1	500/	1.5 mm ²	2482220000	23,15 TL	50
APGTB 1.5 FT 3C/1	500/17.5	1.5 mm ²	2482180000	8,15 TL	50

Serinin devamı sayfa 20

Klippon Connect PUSH IN Klemens Serisi



APGTB 2.5 FT 2C/1



APGTB 2.5 FT 3C/1

Tip	V / A	Kesit (Yüksüksüz)	Sipariş No	Fiyat/Birim	Ambalaj
APGTB 1.5 FT 3C/1 BL	500/17.5	1.5 mm ²	2482190000	8,15 TL	50
APGTB 1.5 PE 3C/1	500/	1.5 mm ²	2482230000	28,80 TL	50
APGTB 1.5 FT 4C/2	500/17.5	1.5 mm ²	2482200000	9,20 TL	50
APGTB 1.5 FT 4C/2 BL	500/17.5	1.5 mm ²	2482210000	9,20 TL	50
APGTB 1.5 PE 4C/2	500/	1.5 mm ²	2482240000	30,85 TL	50
APGTB 1.5 2T 4C/2	500/17.5	1.5 mm ²	2485840000	12,80 TL	50
APGTB 1.5 2T 4C/2 BL	500/17.5	1.5 mm ²	2485850000	12,80 TL	50
APGTB 1.5 2T FT-PE 4C/2	500/17.5	1.5 mm ²	2485860000	29,45 TL	50
APGTB 1.5 2T PE 4C/2	500/	1.5 mm ²	2485870000	45,50 TL	50
APGTB 1.5 2T VL 4C/2	500/17.5	1.5 mm ²	2485920000	28,75 TL	50
APGTB 1.5 2T VL 4C/2 BL	500/17.5	1.5 mm ²	2485930000	28,75 TL	50
APGTB 2.5 FT 2C/1	800/24	2.5 mm ²	1513970000	7,15 TL	100
APGTB 2.5 FT 2C/1 BL	800/24	2.5 mm ²	1513990000	7,55 TL	100
APGTB 2.5 PE 2C/1	800/24	2.5 mm ²	1513870000	23,90 TL	50
APGTB 2.5 FT 3C/1	800/24	2.5 mm ²	1514000000	11,05 TL	50
APGTB 2.5 FT 3C/1 BL	800/24	2.5 mm ²	1514020000	9,40 TL	50
APGTB 2.5 PE 3C/1	800	2.5 mm ²	1513890000	36,00 TL	50
APGTB 2.5 FT 4C/2	800/24	2.5 mm ²	1514030000	14,70 TL	50
APGTB 2.5 FT 4C/2 BL	800/24	2.5 mm ²	1514040000	12,30 TL	50
APGTB 2.5 PE 4C/2	800/	2.5 mm ²	1513920000	37,35 TL	50
APGTB 2.5 2T 4C/2	800/24	2.5 mm ²	1548060000	13,25 TL	50
APGTB 2.5 2T 4C/2 BL	800/24	2.5 mm ²	1548070000	18,65 TL	50
APGTB 2.5 2T VL 4C/2	800/24	2.5 mm ²	1548140000	35,55 TL	50
APGTB 2.5 2T VL 4C/2 BL	800/24	2.5 mm ²	1548150000	37,40 TL	50
APGTB 2.5 2T FT-PE 4C/2	800/24	2.5 mm ²	1548130000	31,75 TL	50
APGTB 2.5 2T PE 4C/2	800/24	2.5 mm ²	1548160000	47,05 TL	50
APG 2.5/3-BG-BL-GN	800/24	2.5 mm ²	1513820000	22,00 TL	25
Soket Grup Aksesuarları					
MCV APG 1.5	APG 1,5 Serisi		2485980000	3,65 TL	50
AEP PGTB 1.5 4C/2	PGTB 1.5 4C/2 Serisi		2482510000	4,05 TL	50
AEP PGTB 1.5 4C/2 BL	PGTB 1.5 4C/2 BL Serisi		2482520000	4,05 TL	50
APG 1.5 L	500/17.5	1.5 mm ²	2482250000	8,15 TL	50
APG 1.5 L BL	500/17.5	1.5 mm ²	2482260000	8,15 TL	50
APG 1.5 L GN	500/17.5	1.5 mm ²	2482270000	8,15 TL	50
APG 1.5 MI	500/17.5	1.5 mm ²	2482280000	8,15 TL	50
APG 1.5 MI BL	500/17.5	1.5 mm ²	2482290000	8,15 TL	50
APG 1.5 MI GN	500/17.5	1.5 mm ²	2482300000	8,15 TL	50
APG 1.5 R	500/17.5	1.5 mm ²	2482310000	8,15 TL	50
APG 1.5 R BL	500/17.5	1.5 mm ²	2482320000	8,15 TL	50
APG 1.5 R GN	500/17.5	1.5 mm ²	2482330000	8,15 TL	50
APG 1.5/1	500/17.5	1.5 mm ²	2482340000	8,15 TL	50
APG 1.5/2	500/17.5	1.5 mm ²	2482350000	13,75 TL	25
APG 1.5/3	500/17.5	1.5 mm ²	2482360000	19,30 TL	25
APG 1.5/3-BG-BL-GN	500/17.5	1.5 mm ²	2482460000	22,00 TL	25
APG 1.5/4	500/17.5	1.5 mm ²	2482370000	24,85 TL	25
APG 1.5/4-3BG-GN	500/17.5	1.5 mm ²	2482450000	27,90 TL	25
APG 1.5/5	500/17.5	1.5 mm ²	2482380000	30,40 TL	25
APG 1.5/5-3BG-BL-GN	500/17.5	1.5 mm ²	2482440000	33,50 TL	25
APG 1.5/6	500/17.5	1.5 mm ²	2482390000	36,00 TL	25
APG 1.5/7	500/17.5	1.5 mm ²	2482400000	41,60 TL	25
APG 1.5/8	500/17.5	1.5 mm ²	2482410000	47,05 TL	20

Serinin devamı sayfa 21



APG 2.5 L



APG 2.5/1



APG 2.5/3



AEB 35 SC/1



AEP 2C 1.5



AEP 3C 1.5

Tip	V / A	Kesit (Yüksüksüz)	Sipariş No	Fiyat/Birim	Ambalaj
APG 1.5/9	500/17.5	1.5 mm ²	2482420000	52,65 TL	20
APG 1.5/10	500/17.5	1.5 mm ²	2482430000	58,20 TL	20
MCV APG 2.5	500/17.5	1.5 mm ²	2035590000	4,20 TL	50
AEP PGTB 2.5 4C/2	500/17.5	1.5 mm ²	1514450000	4,20 TL	50
AEP PGTB 2.5 4C/2 BL	500/17.5	1.5 mm ²	1514470000	4,20 TL	50
APG 2.5 L	500/17.5	2.5 mm ²	1513830000	9,00 TL	50
APG 2.5 L BL	500/17.5	2.5 mm ²	1513840000	9,00 TL	50
APG 2.5 L GN	500/17.5	2.5 mm ²	1513850000	9,00 TL	50
APG 2.5 MI	500/17.5	2.5 mm ²	1513880000	9,00 TL	50
APG 2.5 MI BL	500/17.5	2.5 mm ²	1513900000	9,00 TL	50
APG 2.5 MI GN	500/17.5	2.5 mm ²	1513930000	9,00 TL	50
APG 2.5 R	500/17.5	2.5 mm ²	1513940000	9,00 TL	50
APG 2.5 R BL	500/17.5	2.5 mm ²	1513950000	9,00 TL	50
APG 2.5 R GN	500/17.5	2.5 mm ²	1513980000	9,00 TL	50
APG 2.5/1	1 pin	2.5 mm ²	1513720000	8,55 TL	50
APG 2.5/2	2 pin	2.5 mm ²	1513640000	12,95 TL	25
APG 2.5/3	3 pin	2.5 mm ²	1513650000	17,70 TL	25
APG 2.5/3-BG-BL-GN	3 pin	2.5 mm ²	1513820000	22,00 TL	25
APG 2.5/4	4 pin	2.5 mm ²	1513670000	25,25 TL	25
APG 2.5/4-3BG-GN	4 pin	2.5 mm ²	1513790000	33,10 TL	25
APG 2.5/5	5 pin	2.5 mm ²	1513680000	30,90 TL	25
APG 2.5/5-3BG-BL-GN	5 pin	2.5 mm ²	1513780000	38,55 TL	25
APG 2.5/6	6 pin	2.5 mm ²	1513690000	36,70 TL	25
APG 2.5/7	7 pin	2.5 mm ²	1513700000	42,05 TL	25
APG 2.5/8	8 pin	2.5 mm ²	1513730000	47,80 TL	20
APG 2.5/9	9 pin	2.5 mm ²	1513740000	53,55 TL	20
APG 2.5/10	10 pin	2.5 mm ²	1513770000	59,25 TL	20

Tip	Açıklama	Sipariş No	Fiyat/Birim	Ambalaj
Durdurucular				
AEB 35 SC/1	Klemens durdurucu	1991920000	4,40 TL	50
ZEW 35/2	Vidasız Tip 8mm Kalınlık	8630740000	5,20 TL	20

Tip	Renk	Açıklama	Sipariş No	Fiyat/Birim	Ambalaj
Sonlandırma ve Ayırma Plakaları					
AEP 2C 1.5	Bej	A2C 1.5 Serisi	1552600000	3,60 TL	50
AEP 2C 1.5 BL	Mavi	A2C 1.5 Serisi	1552610000	3,60 TL	50
AEP 3C 1.5	Bej	A3C 1.5 PE Serisi	1552620000	4,45 TL	50
AEP 4C 1.5	Bej	A4C 1.5 Serisi	1552640000	3,65 TL	50
AEP 4C 1.5 BL	Mavi	A4C 1.5 Serisi	1552650000	3,65 TL	50
AEP 2C 2.5	Bej	A2C 2.5 Serisi	1514400000	3,65 TL	50
AEP 2C 2.5 BL	Mavi	A2C 2.5 Serisi	1514420000	3,65 TL	50
AEP 3C 2.5	Bej	A3C 2.5 Serisi	1521510000	3,70 TL	50
AEP 3C 2.5 BL	Mavi	A3C 2.5 Serisi	1521520000	3,70 TL	50
AEP 4C 2.5	Bej	A4C 2.5 Serisi	1521530000	3,80 TL	50
AEP 4C 2.5 BL	Mavi	A4C 2.5 Serisi	1521640000	3,80 TL	50
AEP 3C 4	Bej	A3C 4 Serisi	2051720000	5,95 TL	20
AEP 3C 4 BL	Mavi	A3C 4 Serisi	2051880000	5,95 TL	20
AEP 2C 4	Bej	A2C 4 Serisi	2051680000	4,10 TL	50
AEP 2C 4 BL	Mavi	A2C 4 Serisi	2051690000	4,10 TL	50
AEP 4C 4	Bej	A4C 4 Serisi	2051900000	5,25 TL	20
AEP 4C 4 BL	Mavi	A4C 4 Serisi	2051910000	5,25 TL	20

Serinin devamı sayfa 22

Klippon Connect PUSH IN Klemens Serisi

Tip	Renk	Açıklama	Sipariş No	Fiyat/Birim	Ambalaj
AEP 2C 6	Bej	A2C 6 Serisi	1991970000	5,60 TL	50
AEP 2C 6 BL	Mavi	A2C 6 Serisi	1991950000	5,60 TL	50
AEP 3C 6	Bej	A3C 6 Serisi	1991940000	5,80 TL	50
AEP 3C 6 BL	Mavi	A3C 6 Serisi	1991910000	5,80 TL	20
AEP 2C 10/16		A2C 10/16 Serisi	2490380000	6,60 TL	20
AEP 2C 10/16 BL		A2C 10/16 Serisi	2490390000	6,60 TL	20
AEP 3C 10/16		A3C 10/16 Serisi	2490530000	6,95 TL	20
AEP 3C 10/16 BL		A3C 10/16 Serisi	2490540000	6,95 TL	20
AEP 2T 2.5	Bej	A2T 2.5 Serisi	1547690000	4,05 TL	20
AEP 2T 2.5 BL	Mavi	A2T 2.5 Serisi	1547700000	4,05 TL	20
AEP 3T 2.5	Bej	A3T 2.5 Serisi	2428560000	6,75 TL	20
AEP 3T 2.5 BL	Mavi	A3T 2.5 Serisi	2428860000	6,75 TL	20
AEP MC 2.5	Bej	AMC 2.5 Serisi	2433820000	6,75 TL	25
AEP DT 2.5 3C	Bej	ADT 2.5 3CW/O DTLV	1989970000	4,05 TL	50
AEP DT 2.5 4C	Bej	ADT 2.5 4C Serisi	1989980000	4,10 TL	50
AEP 4C 2.5 BK	Siyah	AFS 2.5 CF 2C Serisi	2486660000	4,95 TL	50
AEP 3C 4 BK	Siyah	AFS 4 2C Serisi	2486640000	6,15 TL	20

Tip	Kutup	Açıklama	Sipariş No	Fiyat/Birim	Ambalaj
Üst Köprüler					
ZQV 1.5N/2	2-pole	ZQV 1.5N	1985410000	3,60 TL	60
ZQV 1.5N/3	3-pole	ZQV 1.5N	1985480000	6,35 TL	60
ZQV 1.5N/4	4-pole	ZQV 1.5N	1985490000	9,40 TL	60
ZQV 1.5N/5	5-pole	ZQV 1.5N	1985500000	12,40 TL	20
ZQV 1.5N/6	6-pole	ZQV 1.5N	1985510000	15,85 TL	20
ZQV 1.5N/7	7-pole	ZQV 1.5N	1985520000	19,10 TL	20
ZQV 1.5N/8	8-pole	ZQV 1.5N	1985540000	22,35 TL	20
ZQV 1.5N/9	9-pole	ZQV 1.5N	1985560000	25,45 TL	20
ZQV 1.5N/10 OR	10-pole	ZQV 1.5N	1985580000	27,95 TL	20
ZQV 1.5N/10 BL	10-pole	ZQV 1.5N	1985680000	27,95 TL	20
ZQV 1.5N/10 RD	10-pole	ZQV 1.5N	1985800000	27,95 TL	20
ZQV 1.5N/20	20-pole	ZQV 1.5N	1985600000	53,20 TL	20
ZQV 1.5N/50	50-pole	ZQV 1.5N	1985620000	145,85 TL	5
ZQV 2.5N/2	2-pole	ZQV 2.5N	1527540000	3,60 TL	60
ZQV 2.5N/3	3-pole	ZQV 2.5N	1527570000	6,35 TL	60
ZQV 2.5N/4	4-pole	ZQV 2.5N	1527590000	9,40 TL	60
ZQV 2.5N/5	5-pole	ZQV 2.5N	1527620000	12,40 TL	20
ZQV 2.5N/6	6-pole	ZQV 2.5N	1527630000	15,85 TL	20
ZQV 2.5N/7	7-pole	ZQV 2.5N	1527640000	19,10 TL	20
ZQV 2.5N/8	8-pole	ZQV 2.5N	1527670000	22,35 TL	20
ZQV 2.5N/9	9-pole	ZQV 2.5N	1527680000	25,45 TL	20
ZQV 2.5N/10	10-pole	ZQV 2.5N	1527690000	27,95 TL	20
ZQV 2.5N/20	20-pole	ZQV 2.5N	1527720000	53,20 TL	20
ZQV 2.5N/50	50-pole	ZQV 2.5N	1527730000	145,85 TL	5
ZQV 4N/2	2-pole	ZQV 4N	1527930000	3,70 TL	60
ZQV 4N/3	3-pole	ZQV 4N	1527940000	6,80 TL	60
ZQV 4N/4	4-pole	ZQV 4N	1527970000	10,15 TL	60
ZQV 4N/5	5-pole	ZQV 4N	1527980000	13,30 TL	60
ZQV 4N/6	6-pole	ZQV 4N	1527990000	16,55 TL	20
ZQV 4N/7	7-pole	ZQV 4N	1528020000	19,70 TL	20
ZQV 4N/8	8-pole	ZQV 4N	1528030000	22,95 TL	20
ZQV 4N/9	9-pole	ZQV 4N	1528070000	26,00 TL	20



ZQV 1.5N/2



ZQV 1.5N/4



ZQV 2.5N/50



ZQV 4N/4

Serinin devamı sayfa 23



AIO21 1.5 SI



AEP IO21



AAP11 6 LO RD



AAP11 6 LO OR



AAP11 1.5 LI RD

Tip	Kutup	Açıklama	Sipariş No	Fiyat/Birim	Ambalaj
ZQV 4N/10	10-pole	ZQV 4N	1528090000	29,85 TL	20
ZQV 4N/50	50-pole	ZQV 4N	1528130000	170,45 TL	5
ZQV 6N/2	2-pole	ZQV 6N	1985740000	4,45 TL	60
ZQV 6N/3	3-pole	ZQV 6N	1985760000	9,00 TL	60
ZQV 6N/4	4-pole	ZQV 6N	1985780000	13,30 TL	60

Tip	V / A	Kesit (Yüksüksüz)	Sipariş No	Fiyat/Birim	Ambalaj
Sensör Bağlantı Klemensleri					
AIO21 1.5 SI	250/13.5	1.5 mm ²	1992260000	21,95 TL	100
AIO21 1.5 SO	250/13.5	1.5 mm ²	1992240000	20,50 TL	100
AIO21 1.5 SO-PE	250/13.5	1.5 mm ²	1992250000	37,25 TL	100
AIO22 1.5 SI-PE	250/13.5	1.5 mm ²	1992230000	39,35 TL	100
AIO23 1.5 2SI	250/13.5	1.5 mm ²	1992220000	41,85 TL	50

Sensör Bağlantı Klemensleri Yan Kapakları					
AEP IO21	AIO21		1993580000	5,25 TL	50
AEP IO22	AIO22		1993590000	5,25 TL	50
AEP IO23	AIO23		1993600000	6,35 TL	50

Klippon AAP Serisi PUSH - IN Güç Dağıtım Klemensleri

Potansiyel Dağıtım Klemensleri					
AAP11 6 LO RD	500/41	6 mm ²	1989780000	20,95 TL	20
AAP11 6 LO BL/OR	500/41	6 mm ²	2522720000	22,00 TL	20
AAP11 6 LO BL	500/41	6 mm ²	1988130000	20,95 TL	20
AAP11 6 LO OR	500/41	6 mm ²	2503650000	22,00 TL	20
AAP11 6 FE	500/41	6 mm ²	1988140000	34,55 TL	20
AAP11 1.5 LI RD	500/17.5	1.5 mm ²	1988160000	23,00 TL	50
AAP11 1.5 LI BL	500/17.5	1.5 mm ²	1988170000	23,00 TL	50
AAP11 1.5 LI BL/OR	500/17.5	1.5 mm ²	2522870000	24,25 TL	50
AAP11 1.5 LI OR	500/17.5	1.5 mm ²	2503910000	24,25 TL	50
AAP13 6 LO-LO	250/41	6 mm ²	1988260000	36,60 TL	20
AAP13 6 FE-LO	250/41	6 mm ²	1988270000	52,40 TL	20
AAP13 1.5 LI-LI	250/17.5	1.5 mm ²	1988280000	26,20 TL	50
AAP12 10 LO RD	800/57	10 mm ²	1988190000	47,10 TL	20
AAP12 10 LO BL	800/57	10 mm ²	1988180000	47,10 TL	20
AAP12 10 LO BL/OR	800/57	10 mm ²	2522860000	49,55 TL	20
AAP12 10 LO OR	800/57	10 mm ²	2503900000	49,55 TL	20
AAP12 10 FE	800/57	10 mm ²	1988200000	62,80 TL	20
AAP12 2.5 LI RD	800/24	2.5 mm ²	1988290000	26,20 TL	50
AAP12 2.5 LI BL	800/24	2.5 mm ²	1988100000	26,20 TL	50
AAP12 2.5 LI BL/OR	800/24	2.5 mm ²	2522840000	27,55 TL	50
AAP12 2.5 LI OR	800/24	2.5 mm ²	2503880000	27,55 TL	50
AAP14 10 LO-LO	500/57	10 mm ²	1988250000	62,80 TL	20
AAP14 10 FE-LO	500/57	10 mm ²	1988240000	73,25 TL	20
AAP14 2.5 LI-LI	500/24	2.5 mm ²	1988230000	26,20 TL	50
AAP21 10 LO RD	250/57	10 mm ²	2428910000	60,75 TL	20
AAP21 10 LO BL	250/57	10 mm ²	2428940000	60,75 TL	20
AAP21 10 FE	250	10 mm ²	2428920000	81,15 TL	20
AAP21 4 LI RD	250/32	4 mm ²	2428930000	18,25 TL	50
AAP21 4 LI BL	250/32	4 mm ²	2428960000	18,25 TL	50
AAP21 4 FS	250/6,3	4 mm ²	2428950000	53,75 TL	50
AAP21 4 DT	250/20	4 mm ²	2428980000	43,20 TL	50
AAP21 4 FS 10-36V	36/6,3	4 mm ²	2458990000	94,25 TL	50

Serinin devamı sayfa 24

Klippon Connect PUSH IN Klemens Serisi



AEP AP11

Tip	V / A	Kesit (Yüksüksüz)	Sipariş No	Fiyat/Birim	Ambalaj
AAP21 4 FS 100-250V	250/6,3	4 mm ²	2460180000	94,25 TL	50
AAP21 4 FS 30-70V	70/6,3	4 mm ²	2460200000	94,25 TL	50
AAP21 4 FS 60-150V	150/6,3	4 mm ²	2460190000	94,25 TL	50
AAP22 10 LO-LO (Bej / Kırmızı / Mavi Soket)	250/10	10 mm ²	2428990000	81,15 TL	20
AAP22 10 FE-LO (Bej / Kırmızı / Mavi Soket)	250/10	10 mm ²	2429000000	94,70 TL	20
AAP22 4 LI-FS	250/6,3	4 mm ²	2429010000	71,75 TL	50
AAP22 4 LI-FS 10-36V	36/6,3	4 mm ²	2459010000	109,00 TL	50
AAP22 4 LI-FS 30-70V	70/6,3	4 mm ²	2460140000	109,00 TL	50
AAP22 4 LI-FS 60-150V	150/6,3	4 mm ²	2460130000	109,00 TL	50
AAP22 4 LI-FS 100-250V	250/6,3	4 mm ²	2460120000	109,00 TL	50
Potansiyel Dağıtım Klemensleri Sonlandırma Plakaları					
AEP AP11	APP11		1988320000	5,25 TL	20
AEP AP12	APP12		1988300000	5,25 TL	20
AEP AP13	APP13		1990140000	6,35 TL	20
AEP AP14	APP14		1988340000	6,35 TL	20
AEP AP21	APP21		2429020000	6,80 TL	20
AEP AP22	APP22		2429040000	8,10 TL	20

P Serisi Ray Klemensleri - Push-In Bağlantı Teknolojisi

Weidmüllerin bağlantı teknolojisine yön veren yeni jenerasyon klemensi 16 mm² ye kadar kullanılan 5 ayrı kesitteki klemens sayısını 3'e düşürüyor.

Yeni P serisi geçiş ve topraklama klemensleri, 2, 3 ve 4 iletken bağlanabilen modeller, sigortalılar, ayırma ve dağıtıcı klemens çeşitlerinde imal edilmektedir.

Siz de bu yenilikçi avantajlardan faydalanın:

- Daha az sayıda ürün kodu - daha az stok, daha az sipariş kodu. Bu hem zamandan hem de maliyetten tasarruf sağlayacak.
- Daha İnce: Aynı kesitlerde daha az yer kaplayarak daha kolay tasarım yapmanızı sağlayacak hem de yerden kazanacaksınız.

Yeni P serisi push in tekniğini kullanarak yepyeni imkanlar yaratır. İzolasyonu sıyrılmış tek damarlı ve kablo pabucu kullanılan çok damarlı iletkenler basitçe klemens yuvasına itirilerek el aleti gerektirmeden montaj tamamlanır. % 50 den daha fazla zaman tasarrufu sağlanır.

Bu şekilde çok güvenilir bağlantı oluşturulur.

Bazı Klemens Tipleri:

- **PDU** - Geçiş Klemensleri
- **PPE** - Topraklama Klemensleri
- **PNT** - Nötr Dağıtım Klemensleri
- **PDK** - İki Katlı Klemensler
- **PDL** - Üç Katlı Dağıtım Klemensleri
- **PTR** - Ölçme Ayırma Klemensleri

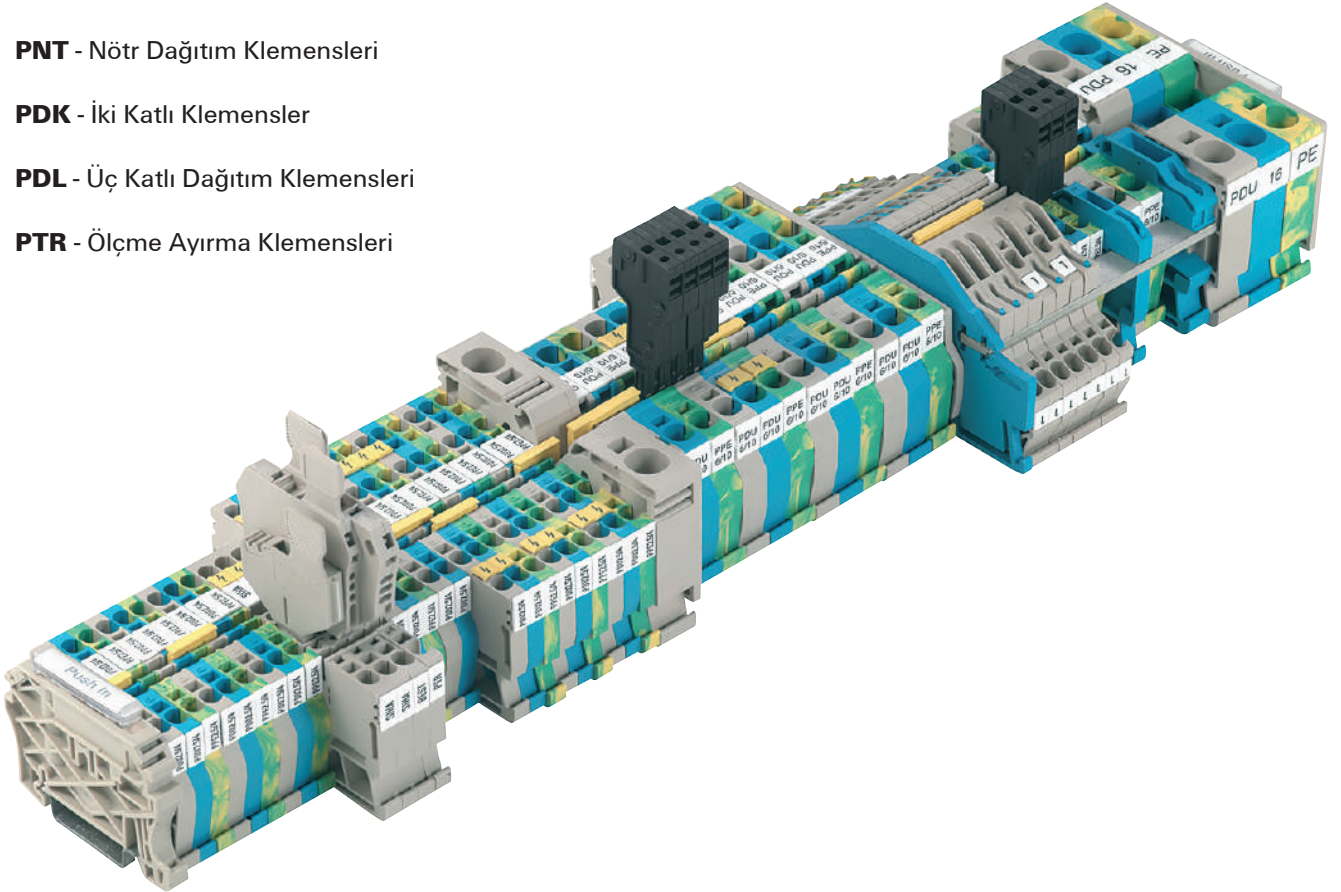

PUSH IN Serisi Ray Klemensleri ve Aksesuarları



PDU 2.5/4



PDU 2.5/4/3AN



PDK 2.5/4



PDL 4 S/L/L/PE



PPE 2.5/4



PTR 2.5/4



PSI 6/10



SIHA 3/G20/LD 10-36V

Tip	V / A	Kesit (Yüksüksüz)	Sipariş No	Fiyat/Birim	Ambalaj
Geçiş Klemensleri					
PDU 2.5/4	800 / 32	0.5 - 6 mm ²	1896110000	5,15 TL	100
PDU 2.5/4 BL	800 / 32	0.5 - 6 mm ²	1896230000	5,15 TL	100
PDU 6/10	800 / 57	1.5 - 10 mm ²	1896140000	10,15 TL	50
PDU 6/10 BL	800 / 57	1.5 - 10 mm ²	1896270000	10,15 TL	25
PDU 16	800 / 76	2.5 - 16 mm ²	1896400000	16,90 TL	25
PDU 16 BL	800 / 76	2.5 - 16 mm ²	1896220000	16,90 TL	10
İkili Geçiş Klemensleri					
PDU 2.5/4/3AN	800 / 32	0.5 - 6 mm ² / Bir giriş, İki çıkış	1896120000	11,00 TL	100
PDU 2.5/4/4AN	800 / 32	0.5 - 6 mm ² / İki giriş, İki çıkış	1896130000	13,35 TL	100
PDU 6/10/3AN	800 / 57	1.5 - 10 mm ² / Bir giriş, İki çıkış	1896150000	19,55 TL	50
PDU 6/10/4AN	800 / 57	1.5 - 10 mm ² / İki giriş, İki çıkış	1083040000	30,10 TL	50
İki Katlı Klemensler (Her İki Kat Köprülenebilir)					
PDK 2.5/4	800 / 24	0.5 - 6 mm ²	1918770000	17,70 TL	50
PDK 2.5/4 PE	800 / 24	0.5 - 6 mm ² / Her iki kat toprak bağlantı	1918710000	49,75 TL	50
PDK 2.5/4L-PE	800 / 24	0.5 - 6 mm ² / Üst L - Alt kat toprak bağlantı	1918720000	49,75 TL	50
PDK 2.5/4V	800 / 57	0.5 - 6 mm ² / Her iki kat içeriden köprü	1918730000	38,20 TL	50
PDK 2.5/4N-L	800 / 57	0.5 - 6 mm ²	1918740000	29,65 TL	50
Üç ve Dört Katlı Klemensler (Her Kat Köprülenebilir)					
PDL 4 S/L/L/PE	400 / 32	0.5 - 6 mm ²	1837040000	29,65 TL	50
PDL 4 S/N/L/PE	400 / 32	0.5 - 6 mm ²	1837050000	29,65 TL	50
PDL 4 S/NT/L/PE	400 / 32	0.5 - 6 mm ² / Notr baralı sistem	1837060000	32,45 TL	50
PDL 4/NT/L/PE	400 / 32	0.5 - 6 mm ² / Notr ayırma modül sistemi	1882620000	38,75 TL	50
PMAK 4	400 / 30	0.5 - 6 mm ² / 3L + PE Motor Klemensi / 4 Kat	1221340000	60,20 TL	50
PMAK 4 800V	800 / 32	0.5 - 6 mm ² / 3L + PE Motor Klemensi / 4 Kat	1221350000	68,40 TL	50
Topraklama Klemensleri					
PPE 2.5/4	800	0.5 - 6 mm ²	1896170000	21,95 TL	50
PPE 6/10	800	1.5 - 10 mm ²	1896180000	34,40 TL	25
PPE 16	800	2.5 - 16 mm ²	1896210000	49,75 TL	10
PPE 2.5/4/3AN	800	0.5 - 6 mm ²	1896200000	32,00 TL	50
PPE 2.5/4/4AN	800	0.5 - 6 mm ²	1896160000	32,95 TL	50
PPE 6/10/3AN	800	1.5 - 10 mm ²	1896190000	48,25 TL	25
Ölçme Ayırma Klemensleri					
PTR 2.5/4	500 / 22	0.5 - 6 mm ² / Test ayırma	1933950000	21,95 TL	50
PTR 2.5/4 BL	500 / 22	0.5 - 6 mm ² / Test ayırma / Mavi	1933970000	21,95 TL	50
PTR 2.5/4/3AN	500 / 22	0.5 - 6 mm ² / Test ayırma / Bir giriş, iki çıkış	1933980000	26,35 TL	50
PTR 2.5/4/4AN	500 / 22	0.5 - 6 mm ² / Test ayırma / İki giriş, iki çıkış	1933940000	30,65 TL	50
PTL 6/10/STB	800 / 57	1.5 - 10 mm ² / Test ayırma / Test Soket	1084780000	45,85 TL	50
PTD 6/10/STB	800 / 57	1.5 - 10 mm ² / Sürgü ayırma / Test Soket	1084790000	32,45 TL	50
Sigortalı Klemensler ve Aksesuarları					
PSI 6/10	250 / 6.3	0.5 - 6 mm ² / 5X20 Sigorta / LED	1083050000	56,35 TL	25
PTR 2.5/4 O.TNHE	500 / 6.3	SIHA ve BEST modül için	1933910000	21,05 TL	50
PTR 2.5/4/3AN O.TNHE	500 / 6.3	SIHA ve BEST modül için / Bir Giriş, İki Çıkış	1933990000	23,90 TL	50
PTR 2.5/4/4AN O.TNHE	500 / 6.3	SIHA ve BEST modül için / İki Giriş, İki Çıkış	1933890000	27,70 TL	50
PDL 4/TR/DU O.TNHE	500 / 6.3	SIHA ve BEST modül için / İki Katlı / Üst Kat Sigortalı	1899210000	26,75 TL	50
PDL 4/TR/DU/PE O.TNHE	500 / 6.3	SIHA ve BEST modül için / Üç Katlı / Üst Kat Sigortalı / Toprak	1899220000	35,90 TL	50
SIHA 3/G20	400	Sigorta Modül	7921560000	23,90 TL	25
SIHA 3/G20/LD 10-36V	10 - 36	10-36V AC-DC Led Sigorta Modül	7921570000	52,10 TL	25
SIHA 3/G20/LD 140-250V	140 - 250	140-250V Led Sigorta Modül	7921600000	56,35 TL	25
BEST		Boş Modül	1833100000	39,20 TL	50

Serinin devamı sayfa 27

Tip	V / A	Kesit (Yüksüksüz)	Sipariş No	Fiyat/Birim	Ambalaj
BEST/DRBR	400 / 41	Jumper Modül	1878570000	50,20 TL	50
BEST/D	Max 250	WTR 2.5/ 1N4007 diyotlu fiş	1878560000	52,10 TL	50

Tip	Açıklama	Sipariş No	Fiyat/Birim	Ambalaj
Nihayet Plakaları				
PAP 2.5/4	PDU 2.5/4 Serisi	1896300000	3,30 TL	50
PAP PDU6/10	PDU 6 /10 Serisi	1896330000	3,65 TL	20
PAP 16	PDU 16 Serisi	1896290000	4,95 TL	10
PAP 2.5/4/3AN	PDU 2.5/4/3AN Serisi	1896480000	3,30 TL	50
PAP 2.5/4/4AN	PDU 2.5/4/4AN Serisi	1896320000	3,30 TL	50
PAP PDU6/10/3AN	PDU 6/10/3AN Serisi	1896340000	5,55 TL	20
PAP PDK 2.5/4	PDK 2.5/4 Serisi	1919720000	6,50 TL	20
PAP PMAK 4	PMAK 4 Serisi	1221360000	8,10 TL	20
PAP PTL/PSI 6/10	PSI 6 Serisi	1165320000	8,45 TL	20
PAP PTR2.5/4	PTR 2.5/4 Serisi	1934680000	3,65 TL	20
PAP PTR2.5/4/3AN	PTR 2.5/4/3AN Serisi	1934690000	3,70 TL	20
PAP PTR2.5/4/4AN	PTR 2.5/4/4AN Serisi	1934700000	3,80 TL	20
PAP PDL4	PDL 4 NT/L/PE Serisi	1883210000	4,45 TL	20
PHP PDL	PDL 4 S/NT/L/PE - PDL 4 S/L/L/PE Serisi	1837090000	4,45 TL	20
PAP PDL4S	PDL 4S/N/L/PE Serisi	1837070000	4,45 TL	20

Tip	A	Kutup Sayısı	Sipariş No	Fiyat/Birim	Ambalaj
Klemens Üst Köprü					
ZQV 2.5/2	24	2 Kutup / ZDU 2.5 - ZDK 2.5 - ZTR 2.5 Seri	1608860000	3,25 TL	60
ZQV 2.5/3	24	3 Kutup / ZDU 2.5 - ZDK 2.5 - ZTR 2.5 Seri	1608870000	5,80 TL	60
ZQV 2.5/4	24	4 Kutup / ZDU 2.5 - ZDK 2.5 - ZTR 2.5 Seri	1608880000	7,95 TL	60
ZQV 2.5/5	24	5 Kutup / ZDU 2.5 - ZDK 2.5 - ZTR 2.5 Seri	1608890000	11,45 TL	20
ZQV 2.5/6	24	6 Kutup / ZDU 2.5 - ZDK 2.5 - ZTR 2.5 Seri	1608900000	14,30 TL	20
ZQV 2.5/7	24	7 Kutup / ZDU 2.5 - ZDK 2.5 - ZTR 2.5 Seri	1608910000	16,90 TL	20
ZQV 2.5/8	24	8 Kutup / ZDU 2.5 - ZDK 2.5 - ZTR 2.5 Seri	1608920000	19,55 TL	20
ZQV 2.5/9	24	9 Kutup / ZDU 2.5 - ZDK 2.5 - ZTR 2.5 Seri	1608930000	22,40 TL	20
ZQV 2.5/10	24	10 Kutup / ZDU 2.5 - ZDK 2.5 - ZTR 2.5 Seri	1608940000	22,80 TL	20
ZQV 2.5/20	24	20 Kutup / ZDU 2.5 - ZDK 2.5 - ZTR 2.5 Seri	1908960000	53,05 TL	20
ZQV 6N/2	41	2 Kutup / PDU 6/10 Seri	1906210000	6,20 TL	60
ZQV 6N/3	41	3 Kutup / PDU 6/10 Seri	1906220000	11,00 TL	60
ZQV 6N/4	41	4 Kutup / PDU 6/10 Seri	1906230000	16,65 TL	60
ZQV 6N/20	41	20 Kutup / PDU 6/10 Seri	1906240000	60,70 TL	20
ZQV 16/2	76	2 Kutup / ZDU 16 -ZPE 16 Seri	1739690000	11,00 TL	25



PAP 2.5/4



PAP 16



ZQV 2.5/2



ZQV 2.5/4



ZQV 2.5/20

Marshalling, Güç Dağıtım Klemensleri ve Aksesuarları



PRV 4 SW 35X15 RT



PRV 8 SW 35X15 RT/WS



PRV 16 SW 35X15 RT/WS



PPV 4 BL 35X15 DGR



PAP PRV/PPV4 SW



TW PRV4



TW PRV4 1-4

Tip	V / A	Kesit (Yüksüksüz)	Sipariş No	Fiyat/Birim	Ambalaj
Marshalling Geçiş Klemensleri					
PRV 4 SW 35X15 RT	250 / 10	0.2 - 1.5 mm ² / TS35x15 / Dört Kat / 16 Bağlantı	1173810000	81,75 TL	20
PRV 4 BL 35X15 RT	250 / 10	0.2 - 1.5 mm ² / TS35x15 / Dört Kat / 16 Bağlantı	1267890000	81,75 TL	20
PRV 4 SW 35X7.5 RT	250 / 10	0.2 - 1.5 mm ² / TS35x7.5 / Dört Kat / 16 Bağlantı	1173830000	81,75 TL	20
PRV 4 BL 35X7.5 RT	250 / 10	0.2 - 1.5 mm ² / TS35x7.5 / Dört Kat / 16 Bağlantı	1267900000	81,75 TL	20
PRV 4 SW 35X15 WS	250 / 10	0.2 - 1.5 mm ² / TS35x15 / Dört Kat / 16 Bağlantı	1173820000	81,75 TL	20
PRV 4 BL 35X15 WS	250 / 10	0.2 - 1.5 mm ² / TS35x15 / Dört Kat / 16 Bağlantı	1173920000	81,75 TL	20
PRV 4 SW 35X7.5 WS	250 / 10	0.2 - 1.5 mm ² / TS35x7.5 / Dört Kat / 16 Bağlantı	1173840000	81,75 TL	20
PRV 4 BL 35X7.5 WS	250 / 10	0.2 - 1.5 mm ² / TS35x7.5 / Dört Kat / 16 Bağlantı	1173930000	81,75 TL	20
PRV 8 SW 35X15 RT/WS	250 / 8	0.2 - 1.5 mm ² / TS35x15 / Sekiz Kat / 32 Bağlantı	1173740000	157,70 TL	20
PRV 8 BL 35X15 RT/WS	250 / 8	0.2 - 1.5 mm ² / TS35x15 / Sekiz Kat / 32 Bağlantı	1267830000	157,70 TL	20
PRV 8 SW 35X7.5 RT/WS	250 / 8	0.2 - 1.5 mm ² / TS35x7.5 / Sekiz Kat / 32 Bağlantı	1173790000	157,70 TL	20
PRV 8 BL 35X7.5 RT/WS	250 / 8	0.2 - 1.5 mm ² / TS35x7.5 / Sekiz Kat / 32 Bağlantı	1267840000	157,70 TL	20
PRV 8 SW 35X15 WS/RT	250 / 8	0.2 - 1.5 mm ² / TS35x15 / Sekiz Kat / 32 Bağlantı	1173780000	157,70 TL	20
PRV 8 BL 35X15 WS/RT	250 / 8	0.2 - 1.5 mm ² / TS35x15 / Sekiz Kat / 32 Bağlantı	1173900000	157,70 TL	20
PRV 8 SW 35X7.5 WS/RT	250 / 8	0.2 - 1.5 mm ² / TS35x7.5 / Sekiz Kat / 32 Bağlantı	1173800000	157,70 TL	20
PRV 8 BL 35X7.5 WS/RT	250 / 8	0.2 - 1.5 mm ² / TS35x7.5 / Sekiz Kat / 32 Bağlantı	1173910000	157,70 TL	20
PRV 16 SW 35X15 RT/WS	250 / 6	0.2 - 1.5 mm ² / TS35x15 / Onaltı Kat / 64 Bağlantı	1173620000	344,10 TL	20
PRV 16 BL 35X15 RT/WS	250 / 6	0.2 - 1.5 mm ² / TS35x15 / Onaltı Kat / 64 Bağlantı	1267790000	344,10 TL	20
PRV 16 SW 35X7.5 RT/WS	250 / 6	0.2 - 1.5 mm ² / TS35x7.5 / Onaltı Kat / 64 Bağlantı	1173680000	344,10 TL	20
PRV 16 BL 35X7.5 RT/WS	250 / 6	0.2 - 1.5 mm ² / TS35x7.5 / Onaltı Kat / 64 Bağlantı	1267810000	344,10 TL	20
PRV 16 SW 35X15 WS/RT	250 / 6	0.2 - 1.5 mm ² / TS35x15 / Onaltı Kat / 64 Bağlantı	1173650000	344,10 TL	20
PRV 16 BL 35X15 WS/RT	250 / 6	0.2 - 1.5 mm ² / TS35x15 / Onaltı Kat / 64 Bağlantı	1267800000	344,10 TL	20
PRV 16 SW 35X7.5 WS/RT	250 / 6	0.2 - 1.5 mm ² / TS35x7.5 / Onaltı Kat / 64 Bağlantı	1173710000	344,10 TL	20
PRV 16 BL 35X7.5 WS/RT	250 / 6	0.2 - 1.5 mm ² / TS35x7.5 / Onaltı Kat / 64 Bağlantı	1267820000	344,10 TL	20

Güç Dağıtım Klemensleri - Eş Potansiyel Bara Tip

Tip	V / A	Kesit (Yüksüksüz)	Sipariş No	Fiyat/Birim	Ambalaj
PPV 4 BL 35X15 DGR	250 / 17.5	0.2 - 1.5 mm ² / TS35x15 / Dört Kat / 16 Bağlantı	1267910000	87,50 TL	20
PPV 4 GR 35X15 DGR	250 / 17.5	0.2 - 1.5 mm ² / TS35x15 / Dört Kat / 16 Bağlantı	1173880000	87,50 TL	20
PPV 4 BL 35X7.5 DGR	250 / 17.5	0.2 - 1.5 mm ² / TS35x7.5 / Dört Kat / 16 Bağlantı	1267920000	87,50 TL	20
PPV 4 GR 35X7.5 DGR	250 / 17.5	0.2 - 1.5 mm ² / TS35x7.5 / Dört Kat / 16 Bağlantı	1173890000	89,85 TL	20
PPV 8 BL 35X15 DGR	250 / 17.5	0.2 - 1.5 mm ² / TS35x15 / Sekiz Kat / 32 Bağlantı	1267870000	169,20 TL	20
PPV 8 GR 35X15 DGR	250 / 17.5	0.2 - 1.5 mm ² / TS35x15 / Sekiz Kat / 32 Bağlantı	1173850000	169,20 TL	20
PPV 8 BL 35X7.5 DGR	250 / 17.5	0.2 - 1.5 mm ² / TS35x7.5 / Sekiz Kat / 32 Bağlantı	1267880000	169,20 TL	20
PPV 8 GR 35X7.5 DGR	250 / 17.5	0.2 - 1.5 mm ² / TS35x7.5 / Sekiz Kat / 32 Bağlantı	1173870000	169,20 TL	20

Tip

Açıklama

Sipariş No

Fiyat/Birim

Ambalaj

Nihayet Plakaları

PAP PRV/PPV4 SW	PRV4 ve PPV4 Serisi - Siyah	1173750000	4,80 TL	10
PAP PRV/PPV4 GR	PRV4 ve PPV4 Serisi - Gri	1211450000	4,80 TL	10
PAP PRV/PPV8 SW	PRV8 ve PPV8 Serisi - Siyah	1173720000	7,30 TL	10
PAP PRV/PPV8 GR	PRV8 ve PPV8 Serisi - Siyah	1211460000	7,30 TL	10

Ayırma Plakaları

TW PRV4	Baskısız	1173700000	6,00 TL	10
TW PRV4 0-3	0...3 Baskı	1230060000	15,00 TL	10
TW PRV4 1-4	1...4 Baskı	1230050000	15,00 TL	10
TW PRV4 A-D	A...D Baskı	1230070000	15,00 TL	10
TW PRV8	Baskısız	1173670000	9,60 TL	10
TW PRV8 0-7	0...7 Baskı	1230090000	15,30 TL	10
TW PRV8 1-8	1...8 Baskı	1230080000	15,30 TL	10
TW PRV8 A-H	A...H Baskı	1230110000	15,30 TL	10
TW PRV16	Baskısız	1173630000	23,75 TL	10
TW PRV16 0-15	0...15 Baskı	1230130000	29,65 TL	10
TW PRV16 1-16	1...16 Baskı	1230120000	29,65 TL	10
TW PRV16 A-P	A...P Baskı	1230140000	29,65 TL	10



AKE 2.5



WDU 1.5/R3.5



WDK 1.5/R3.5



ZDUA 2.5-2



ZEW 15



ZQV 2.5N/2 GE



ZQV 2.5N/10 GE



ZQV 2.5N/4 GE

Tip	V / A	Kesit (Yüksüksüz)	Sipariş No	Fiyat/Birim	Ambalaj
-----	-------	-------------------	------------	-------------	---------

AKZ Serisi Mini Klemensler

AKZ 1.5	250 / 17.5	0.5 - 1.5 mm ²	0340460000	16,65 TL	100
AKZ 2.5	250 / 24	0.5 - 2.5 mm ²	0697160000	17,70 TL	100
AKZ 4	400 / 32	0.5 - 4 mm ²	0294360000	17,70 TL	100

Topraklama Klemensleri

AKE 2.5	250	0.5 - 2.5 mm ²	1303360000	43,45 TL	100
AKE 4	500	0.5 - 4 mm ²	0380260000	51,55 TL	100

Sigortalı Klemens

ASK 1/15	500 / 6.3	0.5 - 4 mm ²	0376860000	57,85 TL	100
----------	-----------	-------------------------	------------	----------	-----

Ayırma Klemensi

SAKR 15	400 / 10	0.5 - 4 mm ²	0412760000	43,45 TL	100
---------	----------	-------------------------	------------	----------	-----

W Serisi Mini Klemens

WDU 1.5/R3.5	400 / 17.5	0.5 - 1.5 mm ²	1753280000	16,65 TL	100
WDU 1.5/R3.5 BL	400 / 17.5	0.5 - 1.5 mm ²	1754170000	16,65 TL	100

W Serisi Mini İki Katlı Klemens

WDK 1.5/R3.5	400 / 16	0.5 - 1.5 mm ²	1753290000	38,20 TL	100
--------------	----------	---------------------------	------------	----------	-----

W Serisi Mini Topraklama Klemens

WPE 1.5/R3.5	400	0.5 - 1.5 mm ²	1798460000	41,05 TL	100
--------------	-----	---------------------------	------------	----------	-----

Z Serisi Mini Klemens

ZDUA 2.5-2	500 / 24	0.5 - 2.5 mm ²	1720920000	9,60 TL	100
ZDUA 2.5-2 BL	500 / 24	0.5 - 2.5 mm ² / Mavi	1720930000	9,60 TL	100

Z Serisi Mini Topraklama Klemens

ZPEA 2.5-2	500	0.5 - 2.5 mm ²	1720950000	18,65 TL	100
------------	-----	---------------------------	------------	----------	-----

Tip	Açıklama	Sipariş No	Fiyat/Birim	Ambalaj
-----	----------	------------	-------------	---------

Klemens Durdurucuları

ZEW 15	Vidasız Durdurucu	7920340000	4,10 TL	20
EW 15	Vidalı Durdurucu	0382860000	4,40 TL	50

Nihayet Plakaları

AP AKZ1.5	AKZ 1.5 Serisi	0340560000	2,75 TL	50
AP AKZ2.5	AKZ 2.5 Serisi	0697360000	3,25 TL	50
AP AKZ4	AKZ 4 Serisi	0294460000	5,50 TL	20
WAP WDU1.5/R3.5	WDU 1.5/R3.5 Serisi	1754190000	2,30 TL	20
WAP WDK1.5/R3.5	WDK 1.5/R3.5 Serisi	1754200000	7,95 TL	20
ZAP/TW ZDUA	ZDUA Serisi	1720960000	2,30 TL	50
ZAP/TW ZDUA BL	ZDUA Mavi Serisi	1720970000	2,30 TL	50

Üst Köprüler

Q 2 AKZ1.5	AKZ 1.5 - 2.5 Serisi / 2 Kutup	0368200000	7,45 TL	50
Q 3 AKZ1.5	AKZ 1.5 - 2.5 Serisi / 3 Kutup	0368300000	11,45 TL	50
Q 4 AKZ1.5	AKZ 1.5 - 2.5 Serisi / 4 Kutup	0368400000	12,95 TL	50
Q 10 AKZ1.5	AKZ 1.5 - 2.5 Serisi / 10 Kutup	0368500000	39,00 TL	20
ZQV 1.5N/R3.5/2 GE	WDU 1.5 - WDK 1.5 Serisi / 2 Kutup	1754210000	3,65 TL	50
ZQV 1.5N/R3.5/3 GE	WDU 1.5 - WDK 1.5 Serisi / 3 Kutup	1754220000	7,45 TL	50
ZQV 1.5N/R3.5/4 GE	WDU 1.5 - WDK 1.5 Serisi / 4 Kutup	1754230000	11,00 TL	20
ZQV 1.5N/R3.5/10 GE	WDU 1.5 - WDK 1.5 Serisi / 10 Kutup	1754290000	31,10 TL	20
ZQV 2.5N/2 GE	ZDUA Serisi / 2 Kutup	1693800000	3,65 TL	60
ZQV 2.5N/3 GE	ZDUA Serisi / 3 Kutup	1693810000	6,35 TL	60
ZQV 2.5N/4 GE	ZDUA Serisi / 4 Kutup	1693820000	9,05 TL	60
ZQV 2.5N/10 GE	ZDUA Serisi / 10 Kutup	1693880000	25,40 TL	20

Klemens ve Bağlantı Aksesuarları



ZB 10 F.10X3/10X5/10X10



ZF 4 S



SH 2 S



KLBUE CO 1



MK 3/12



MK 6/6



WGK 4

Tip	Kesit	Sipariş No	Fiyat/Birim	Ambalaj	
Bara Klemensleri					
İzolesiz Bara Klemensleri (10x3 mm'lik Bara için)					
ZB 4	0.5 - 4 mm ²	0316500000	4,10 TL	50	
ZBE 6	2.5 - 6 mm ²	0459500000	7,15 TL	50	
ZB 10 F.10X3/10X5/10X10	1.5 - 10 mm ²	1261300000	7,15 TL	50	
ZB 16 ZKSC	2.5 - 16 mm ²	0316600000	7,95 TL	50	
ZB 35/M6X16	16 - 35 mm ²	0266500000	10,05 TL	20	
İzoleli Bara Klemensleri (10x3 mm'lik Bara için)					
ZB 4K BL	0.5 - 4 mm ²	0475380000	6,20 TL	50	
ZB 4K GE/GN	0.5 - 4 mm ²	0475360000	7,50 TL	50	
ZBE 6K BL	2.5 - 6 mm ²	0525980000	10,80 TL	50	
ZBE 6K GE/GN	2.5 - 6 mm ²	0525960000	10,80 TL	50	
ZB 16K BL	2.5 - 16 mm ²	0502880000	11,45 TL	50	
ZB 16K GE/GN	2.5 - 16 mm ²	0502860000	11,45 TL	50	
ZB 35K BL M6X16	16 - 35 mm ²	0502680000	15,80 TL	20	
ZB 35K GE/GN M6X16	16 - 35 mm ²	0502660000	15,80 TL	20	
Yayı İzoleli Bara Klemensleri (10x3 mm'lik Bara için)					
ZF 4 S	0.5 - 4 mm ²	1814680000	8,50 TL	50	
ZF 4 S BL	0.5 - 4 mm ²	1814660000	8,50 TL	50	
ZF 4 S GN	0.5 - 4 mm ²	1814670000	8,50 TL	50	
SSCH 10X3X1000 CU/SN	10x3 Bakır Bara	0348900000	117,50 TL	1	
Bara Tutucular					
SH 1	10x3 / 6x6 / 15x2x12x2 mm	0299860000	12,90 TL	20	
SH 2 S	10x3 / 6x6 / 15x6x10x5 mm	0641720000	40,15 TL	10	
SH 3	10x3 / 6x6 / 10x5 mm	0556660000	20,60 TL	10	
Ekranlama Klemensleri					
KLBUE CO 1	Ø 3...10 mm	1753311001	44,50 TL	10	
KLBUE CO 2	Ø 4...15 mm	1752131001	52,10 TL	10	
KLBUE CO 3	Ø 10...20 mm	1749151001	70,75 TL	10	
KLBUE CO 4	Ø 15...28 mm	1749161001	98,00 TL	10	
KLBUE CO 5	Ø 20...37 mm	1755081001	113,75 TL	10	
Cihaz Sıra Klemensleri					
Tip	V / A	Açıklama	Sipariş No	Fiyat/Birim	Ambalaj
MK 3/2	400 / 24	0.5 - 4 mm ² / 2 Kutup	0273820000	10,80 TL	100
MK 3/3	400 / 24	0.5 - 4 mm ² / 3 Kutup	0273920000	16,25 TL	50
MK 3/4	400 / 24	0.5 - 4 mm ² / 4 Kutup	0274020000	21,95 TL	50
MK 3/6	400 / 24	0.5 - 4 mm ² / 6 Kutup	0274220000	30,10 TL	50
MK 3/8	400 / 24	0.5 - 4 mm ² / 8 Kutup	0274420000	54,55 TL	25
MK 3/10	400 / 24	0.5 - 4 mm ² / 10 Kutup	0274620000	56,85 TL	20
MK 3/12	400 / 24	0.5 - 4 mm ² / 12 Kutup	0243520000	59,80 TL	20
MK 6/2	690 / 21	0.5 - 6 mm ² / 2 Kutup	0620420000	35,35 TL	50
MK 6/3	690 / 21	0.5 - 6 mm ² / 3 Kutup	0620320000	49,25 TL	50
MK 6/4	690 / 21	0.5 - 6 mm ² / 4 Kutup	0620220000	56,85 TL	20
MK 6/6	690 / 21	0.5 - 6 mm ² / 6 Kutup	0620120000	81,25 TL	20
Panel Geçiş Klemensleri					
WGK 4	250 / 32	0.5 - 6 mm ²	1936550000	17,10 TL	50
WGK 95	690 / 232	35 - 95 mm ²	1937380000	157,90 TL	10



FP Box



PTS 4



WPD 130 1X50/1X50 BN



WPD 132 1X185/1X185 BN

Tip	Açıklama	Sipariş No	Fiyat/Birim	Ambalaj
FieldPower Güç Dağıtım Klemensi				
FP Box	IP65 5 Kutup	1957580000	62,75 €	1
FP Box 10P	IP65 10 Kutup	1957590000	127,00 €	1
PowerTerminal LG	IP30 5 Kutup Bağlantı Modülü	1963570000	49,50 €	1
PT6	IP20 5 Kutup Bağlantı Modülü	1957620000	35,85 €	1
FP Box FUSE	IP65 Sinyal Modülü	1961780000	153,20 €	1
FP Box ON/OFF	IP65 Bakım (A) Anahtar	1003260000	245,00 €	1

FieldPower Asansör Uygulamaları				
* FP ESWB LANDING SET	230V / 6A	2483990000	126,00 TL	1
* FP ESWB TERMINAL SET	230V / 6A	2524850000	128,30 TL	1

FieldPower Güç Dağıtım Klemensi Aksesuarlar				
PTS 4	Push-In Bağlantılı Konnektör	1952120000	12,95 €	10
PTDS 4	Her Kutup için İki Bağ. Konnektör	1952130000	14,35 €	10
RKDG D9 PT6	Yuvarlak Kablo Tutucu	4329610000	2,85 €	10
RKDG D11 PT6	Yuvarlak Kablo Tutucu	4323210000	2,85 €	10
RKDG D13 PT6	Yuvarlak Kablo Tutucu	4323230000	2,85 €	10
RKDG D15 PT6	Yuvarlak Kablo Tutucu	4323220000	2,85 €	10
DG D0 PT6	Yassı Kablo Tutucu	4323240000	2,85 €	10

Tip	Kablo Kesiti / Nominal Gerilim	Nominal Akım	Sipariş No	Fiyat/Birim	Ambalaj
WPD Güç Dağıtım Klemensi					
* WPD 130 1X50/1X50 GY	50mm ² / 1000 V	120 A	2502530000	63,60 TL	9
* WPD 130 1X50/1X50 BL	50mm ² / 1000 V	120 A	2502540000	63,60 TL	9
* WPD 130 1X50/1X50 GN	50mm ² / 1000 V	120 A	2502550000	63,60 TL	9
* WPD 130 1X50/1X50 BN	50mm ² / 1000 V	120 A	2502560000	63,60 TL	9
* WPD 130 1X50/1X50 BK	50mm ² / 1000 V	120 A	2502570000	63,60 TL	9
* WPD 230 2X50/2X50 GY	50mm ² / 1000 V	120 A	2502580000	117,50 TL	5
* WPD 230 2X50/2X50 BL	50mm ² / 1000 V	120 A	2502590000	117,50 TL	5
* WPD 230 2X50/2X50 GN	50mm ² / 1000 V	120 A	2502600000	117,50 TL	5
* WPD 230 2X50/2X50 BN	50mm ² / 1000 V	120 A	2502610000	117,50 TL	5
* WPD 230 2X50/2X50 BK	50mm ² / 1000 V	120 A	2502950000	117,50 TL	5
* WPD 330 3X50/3X50 3XGY	50mm ² / 1000 V	120 A	2502620000	182,25 TL	3
* WPD 330 3X50/3X50 1XGY/1XBL/1XGN	50mm ² / 1000 V	120 A	2502640000	182,25 TL	3
* WPD 330 3X50/3X50 1XBN/1XBK/1XGY	50mm ² / 1000 V	120 A	2502650000	182,25 TL	2
* WPD 131 1X95/1X95 BL	95mm ² / 1000 V	155 A	2502660000	120,70 TL	2
* WPD 131 1X95/1X95 GN	95mm ² / 1000 V	155 A	2502670000	120,70 TL	2
* WPD 131 1X95/1X95 BN	95mm ² / 1000 V	155 A	2502680000	120,70 TL	2
* WPD 131 1X95/1X95 BK	95mm ² / 1000 V	155 A	2502690000	120,70 TL	2
* WPD 131 1X95/1X95 GY	95mm ² / 1000 V	155 A	2503090000	120,70 TL	2
* WPD 231 2X95/2X95 GY	95mm ² / 1000 V	155 A	2502700000	236,20 TL	1
* WPD 231 2X95/2X95 BL	95mm ² / 1000 V	155 A	2502710000	236,20 TL	1
* WPD 231 2X95/2X95 GN	95mm ² / 1000 V	155 A	2502720000	236,20 TL	1
* WPD 231 2X95/2X95 BN	95mm ² / 1000 V	155 A	2502730000	236,20 TL	1
* WPD 231 2X95/2X95 BK	95mm ² / 1000 V	155 A	2502740000	236,20 TL	1
* WPD 132 1X185/1X185 GY	185 mm ² / 1000 V	250 A	2502750000	247,00 TL	1
* WPD 132 1X185/1X185 BL	185 mm ² / 1000 V	250 A	2502760000	247,00 TL	1
* WPD 132 1X185/1X185 GN	185 mm ² / 1000 V	250 A	2502770000	247,00 TL	1
* WPD 132 1X185/1X185 BN	185 mm ² / 1000 V	250 A	2502780000	247,00 TL	1
* WPD 132 1X185/1X185 BK	185 mm ² / 1000 V	250 A	2502790000	247,00 TL	1
* WPD 232 2X185/2X185 GY	185 mm ² / 1000 V	250 A	2502800000	484,40 TL	1
* WPD 232 2X185/2X185 BL	185 mm ² / 1000 V	250 A	2502810000	484,40 TL	1

Serinin devamı sayfa 32

Klemens ve Bağlantı Aksesuarları

Tip	Kablo Kesiti / Nominal Gerilim	Nominal Akım	Sipariş No	Fiyat/Birim	Ambalaj
* WPD 232 2X185/2X185 GN	185 mm ² / 1000 V	250 A	2502820000	484,40 TL	1
* WPD 232 2X185/2X185 BN	185 mm ² / 1000 V	250 A	2502830000	484,40 TL	1
* WPD 232 2X185/2X185 BK	185 mm ² / 1000 V	250 A	2502840000	484,40 TL	1
* WPD 133 1X300/1X300 GY	300 mm ² / 1000 V	340 A	2502850000	603,00 TL	1
* WPD 133 1X300/1X300 BL	300 mm ² / 1000 V	340 A	2502860000	603,00 TL	1
* WPD 133 1X300/1X300 GN	300 mm ² / 1000 V	340 A	2502870000	603,00 TL	1
* WPD 133 1X300/1X300 BN	300 mm ² / 1000 V	340 A	2502880000	603,00 TL	1
* WPD 133 1X300/1X300 BK	300 mm ² / 1000 V	340 A	2502890000	603,00 TL	1
* WPD 233 2X300/2X300 GY	300 mm ² / 1000 V	340 A	2502900000	1.196,00 TL	1
* WPD 233 2X300/2X300 BL	300 mm ² / 1000 V	340 A	2502910000	1.196,00 TL	1
* WPD 233 2X300/2X300 GN	300 mm ² / 1000 V	340 A	2502920000	1.196,00 TL	1
* WPD 233 2X300/2X300 BN	300 mm ² / 1000 V	340 A	2502930000	1.196,00 TL	1
* WPD 233 2X300/2X300 BK	300 mm ² / 1000 V	340 A	2502940000	1.196,00 TL	1

Tip	Kesit Aralığı Input / Output	Çalışma Gerilimi	Sipariş No	Fiyat/Birim	Ambalaj
WPD Potansiyel Dağıtım Blokları					
* WPD 104 1x25+1x16/2x16+3x10 BL	25 mm ² / 16 mm ²	1000 V DC	2518250000	220,20 TL	1
* WPD 104 1x25+1x16/2x16+3x10 GY	25 mm ² / 16 mm ²	1000 V DC	1562000000	214,65 TL	1
* WPD 204 2X25/4X16+6X10 2XBL	25 mm ² / 16 mm ²	1000 V DC	2518330000	408,80 TL	1
* WPD 204 2X25/4X16+6X10 2XGY	25 mm ² / 16 mm ²	1000 V DC	1562150000	398,05 TL	1
* WPD 304 3X25/6X16+9X10 3XBL	25 mm ² / 16 mm ²	1000 V DC	2518340000	784,00 TL	1
* WPD 304 3X25/6X16+9X10 3XGY	25 mm ² / 16 mm ²	1000 V DC	1562160000	765,00 TL	1
* WPD 105 1x35+1x16/2x25+3x16 BL	35 mm ² / 25 mm ²	1000 V DC	2518540000	364,85 TL	1
* WPD 105 1x35+1x16/2x25+3x16 GY	35 mm ² / 25 mm ²	1000 V DC	1562170000	354,85 TL	1
* WPD 205 2X35/4X25+6X16 2XBL	35 mm ² / 25 mm ²	1000 V DC	2519470000	718,00 TL	1
* WPD 205 2X35/4X25+6X16 2XGY	35 mm ² / 25 mm ²	1000 V DC	1562180000	701,00 TL	1
* WPD 305 3X35/6X25+9X16 3XGY	35 mm ² / 25 mm ²	1000 V DC	1562190000	1.034,00 TL	1
* WPD 106 1X70/2X25+3X16 BL	70 mm ² / 25 mm ²	1000 V DC	2518570000	441,20 TL	1
* WPD 106 1X70/2X25+3X16 GY	70 mm ² / 25 mm ²	1000 V DC	1562210000	430,45 TL	1
* WPD 107 1X95/2X35+8X25 BL	95 mm ² / 25 mm ²	1000 V DC	2521730000	552,00 TL	1
* WPD 107 1X95/2X35+8X25 GY	95 mm ² / 25 mm ²	1000 V DC	1562220000	538,00 TL	1
* WPD 108 1X120/2X35+3X25+4X16 BL	120 mm ² / 35 mm ²	1500 V DC	2519480000	714,00 TL	1
* WPD 108 1X120/2X35+3X25+4X16	120 mm ² / 35 mm ²	1500 V DC	1562100000	697,00 TL	1
* WPD 109 1X185/2X35+3X25+4X16 BL	185 mm ² / 35 mm ²	1500 V DC	2519490000	730,00 TL	1
* WPD 109 1X185/2X35+3X25+4X16 GY	185 mm ² / 35 mm ²	1500 V DC	1562090000	711,00 TL	1



WPD 104
1x25+1x16/2x16+3x10 GY



TS35 x 7,5



TSTW 5/M5



Schuko TS35

Tip	Açıklama	Sipariş No	Fiyat/Birim	Ambalaj
İthal Raylar				
TS35 x 7,5	Çelik Deliksiz Ray (Sipariş şekli: 40 mt ve katları)	7730000011	20,50 TL	40 mt
TS32	Çelik Deliksiz Ray	7730000012	42,00 TL	20 mt
TS35 x 7,5 D	Çelik Delikli Ray (Sipariş şekli: 40 mt ve katları)	7730000013	23,75 TL	40 mt
TS32 D	Çelik Delikli Ray	7730000014	48,45 TL	20 mt
* TS 35X15	Çelik Deliksiz Ray	7730000490	52,20 TL	20 mt
* TS 35X15 D	Çelik Delikli Ray	7730000458	47,65 TL	20 mt
Orijinal Weidmüller Raylar				
TS 35X7.5 2M/ST/ZN	Çelik Deliksiz Ray	0383400000	42,40 TL	2 mt
TS 35X7.5/LL 2M/ST/ZN	Çelik Delikli Ray (Sipariş şekli: 40 mt ve katları)	0514500000	45,70 TL	40 mt
TS 35X15 2M/ST/ZN	Çelik Deliksiz Ray (Sipariş şekli: 20 mt ve katları)	0236400000	76,40 TL	20 mt
TS 35X15/LL 2M/ST/ZN	Çelik Delikli Ray (Sipariş şekli: 20 mt ve katları)	0236500000	78,25 TL	20 mt
TS 32X15 2M/ST/ZN	Çelik Deliksiz Ray	0122800000	63,85 TL	2 mt
TS 32X15/LL 2M/ST/ZN	Çelik Delikli Ray	0514400000	80,10 TL	2 mt
TS 15X5 2M/ST/ZN	Çelik Deliksiz Ray	0514200000	39,15 TL	2 mt
TS 15X5/LL 2M/ST/ZN	Çelik Delikli Ray	0117500000	39,15 TL	2 mt
Ray Taşıyıcı				
TSTW 5/M5	M5 Ray Montaj Ayağı	0178100000	16,25 TL	10
TSTW 6/M6	M6 Ray Montaj Ayağı	0164000000	16,25 TL	10
SH 2	TS 32 ve TS 35 için	0494920000	35,35 TL	10
TS 35 Raya Montaj Tek Fazlı Priz				
Schuko TS35	Ray Prizi	8734580000	10,80 €	10

Pano İçi LED Aydınlatma Ürünleri



WIL-STANDARD-10-MAG-SW-WHI

Tip	Nom. V / Nom A	Aydınlatma Seviyesi / Işık Rengi (CCT) / Uzunluk	Sipariş No	Fiyat/ Birim	Ambalaj
Vida ile Pano Montajlı					
* WIL-STANDARD-0.3-SCREW-SW-WHI	24 V DC / 420 mA	140 lux / 6500K, White / 240mm	2436210000	175,00 €	1
* WIL-STANDARD-0.3-SCREW-SW-RED	24 V DC / 360 mA	70 lux / Red / 240mm	2436340000	299,70 €	1
* WIL-STANDARD-0.3-SCREW-SW-BLU	24 V DC / 360 mA	135 lux / Blue / 240mm	2436350000	255,30 €	1
* WIL-STANDARD-1.5-SCREW-SW-WH	24 V DC / 420 mA	140 lux / 6500K, White / 240mm	2527880000	173,15 €	1
* WIL-STANDARD-3.0-SCREW-SW-WHI	24 V DC / 420 mA	140 lux / 6500K, White / 240mm	2527890000	179,80 €	1
* WIL-STANDARD-5.0-SCREW-SW-WHI	24 V DC / 420 mA	140 lux / 6500K, White / 240mm	2527900000	190,90 €	1
* WIL-STANDARD-10-SCREW-SW-WHI	24 V DC / 420 mA	140 lux / 6500K, White / 240mm	2527910000	221,80 €	1
Mıknatıs ile Pano Montajlı					
* WIL-STANDARD-1.5-MAG-SW-WHI	24 V DC / 420 mA	140 lux / 6500K, White / 240mm	2527920000	197,35 €	1
* WIL-STANDARD-10-MAG-SW-WHI	24 V DC / 420 mA	140 lux / 6500K, White / 240mm	2527950000	248,65 €	1
* WIL-STANDARD-3.0-MAG-SW-WHI	24 V DC / 420 mA	140 lux / 6500K, White / 240mm	2527930000	208,70 €	1
* WIL-STANDARD-5.0-MAG-SW-WHI	24 V DC / 420 mA	140 lux / 6500K, White / 240mm	2527940000	218,65 €	1
WIL Uzunluk Varyantı					
* WIL-145-W-M12G-0.3U-S	24 V DC / 210 mA	140 lux / 6500K, White / 145mm	2535770000	131,00 €	1
* WIL-350-W-M12G-0.3U-S	24 V DC / 630 mA	140 lux / 6500K, White / 350mm	2535810000	221,80 €	1
* WIL-450-W-M12G-0.3U-S	24 V DC / 840 mA	140 lux / 6500K, White / 450mm	2535830000	286,40 €	1
* WIL-555-W-M12G-0.3U-S	24 V DC / 1050 mA	140 lux / 6500K, White / 555mm	2535850000	353,00 €	1
* WIL-655-W-M12G-0.3U-S	24 V DC / 1260 mA	140 lux / 6500K, White / 655mm	2535870000	419,60 €	1
* WIL-765-W-M12G-0.3U-S	24 V DC / 1470 mA	140 lux / 6500K, White / 765mm	2535890000	509,00 €	1
* WIL-860-W-M12G-0.3U-S	24 V DC / 1680 mA	140 lux / 6500K, White / 860 mm	2535910000	553,00 €	1
Aksesuarlar					
* WIL-MAGNET			2526810000	29,95 €	1

Markalama Sistemleri

Dekafix Klemens Markalama

Çeşitli konnektörler için her türlü markalama isteklerini pratik, hızlı, düzenli ve mükemmel bir görsellikte çözer. Dekafix - kullanıma hazır olan markalama her türlü klemens ve elektronik ekipmana uygundur.

Grup Etiketleri

Grup etiket taşıyıcıları direkt ray üzerine tutturulabildikleri gibi, klemens üzerinde kullanılabilen çeşitleri de mevcuttur. SCHAT 5 ve SCHAT 5S doğrudan DIN ray üzerine tutturulur. Etiketler şeffaf bir koruyucu ile dış etkenlerden izole edilir.

Kablo Etiketleri SlimFix ve SlimFix Clip

SlimFix (SF) kablo etiketleri kablo montajı yapıldıktan sonra takılabilir. Halogenfree malzemeden üretilmiş olup V0/V2 yanmazlık normuna uygun olarak tasarlanmıştır. SF Tool yardımı ile hızlı ve kolayca monte edilebilir. Weidmüller, çok çeşitli markalama imkanları ve baskı teknolojilerini kullanımınıza sunar.

PrintJet Advanced

Renkli baskı teknolojisi ve silinmez baskı özelliği ile alanında eşsiz olan bu cihaz mürekkep püskürtme tekniği ile çalışır. Bu şekilde bireysel yazı şekilleri ve logolar oluşturulabilir.

Mürekkep püskürtmeli renkli baskı tekniği

- Kolay kullanım
- Grafik baskı imkanı
- Dayanıklı yazı ile kazıma yerine kullanılabilme
- Etiketleri baskı sonrası hemen kullanılabilme
- Tüm windows temelindeki programların desteklenmesi
- Tüm multikartlara baskı yapılabilmesi
- Metal Markalama

Hazır Baskılı Kablo Etiketleri CableLine ®

Hazır baskılı kablo etiketler CableLine ® ile 0.5 mm² ile 70mm² arası iletkenler kolay bir şekilde markalanabilir. Kapalı tip ve açık tipleri de mevcuttur. Kablo bağı ile bağlanan renkli versiyonları ayrıca üretilmektedir.

WKM Kablo Markalama

Büyük kesitte kablolar için kablo bağı ile iletkene tutturulan bu tip, ağır sanayi şartlarına uygundur.

- 3 farklı boyut için
- Baskılı etiketler için şeffaf kapak ile koruma
- Tüm kesitler için kablo bağı ile montaj





DEK 5 FW 1-50



DEK 6 FW 1-50



DEK 8 FWZ 1-10

Tip	Baskı	Ölçü	Sipariş No	Fiyat/Birim	Ambalaj
Dekafix					
DEK 5					
DEK 5 FW 1-50	Baskı 1 - 50	5,0 mm	0473460001	0,400 TL	500
DEK 5 FW 51-100	Baskı 51 - 100	5,0 mm	0473460005	0,400 TL	500
DEK 5 FW 101-150	Baskı 101 - 150	5,0 mm	0473460101	0,400 TL	500
DEK 5 FW 151-200	Baskı 151 - 200	5,0 mm	0473460151	0,400 TL	500
DEK 5 FW 201-250	Baskı 201 - 250	5,0 mm	0473460201	0,400 TL	500
DEK 5 FWZ 1-10	Baskı 1 - 10	5,0 mm	0523060001	0,400 TL	500
DEK 5 FWZ 11-20	Baskı 11 - 20	5,0 mm	0523060011	0,400 TL	500
DEK 5 FWZ 21-30	Baskı 21 - 30	5,0 mm	0523060021	0,400 TL	500
DEK 5 FWZ 31-40	Baskı 31 - 40	5,0 mm	0523060031	0,400 TL	500
DEK 5 FWZ 41-50	Baskı 41 - 50	5,0 mm	0523060041	0,400 TL	500
DEK 5 FWZ 51-60	Baskı 51 - 60	5,0 mm	0523060051	0,400 TL	500
DEK 5 FWZ 61-70	Baskı 61 - 70	5,0 mm	0523060061	0,400 TL	500
DEK 5 FWZ 71-80	Baskı 71 - 80	5,0 mm	0523060071	0,400 TL	500
DEK 5 FWZ 81-90	Baskı 81 - 90	5,0 mm	0523060081	0,400 TL	500
DEK 5 FWZ 91-100	Baskı 91 - 100	5,0 mm	0523060091	0,400 TL	500
DEK 5 GW +	Baskı +	5,0 mm	0576261198	0,400 TL	500
DEK 5 GW -	Baskı -	5,0 mm	0576261199	0,400 TL	500
DEK 5 GW ERDE	Baskı Toprak	5,0 mm	0576261202	0,400 TL	500
DEK 5 GW ERDE I.KR.	Baskı Toprak Yuvarlak İçinde	5,0 mm	0576261203	0,400 TL	500
DEK 5 GW L1	Baskı L1	5,0 mm	0522361075	0,400 TL	500
DEK 5 GW L2	Baskı L2	5,0 mm	0522361076	0,400 TL	500
DEK 5 GW L3	Baskı L3	5,0 mm	0522361077	0,400 TL	500
DEK 5 FWZ L1-PE	Baskı L1 - PE	5,0 mm	0354361187	0,400 TL	500
DEK 6					
DEK 6 FW 1-50	Baskı 1 - 50	6,0 mm	0468660001	0,400 TL	500
DEK 6 FW 51-100	Baskı 51 - 100	6,0 mm	0468660005	0,400 TL	500
DEK 6 FW 101-150	Baskı 101 - 150	6,0 mm	0468660101	0,400 TL	500
DEK 6 FW 151-200	Baskı 151 - 200	6,0 mm	0468660151	0,400 TL	500
DEK 6 FW 201-250	Baskı 201 - 250	6,0 mm	0468660201	0,400 TL	500
DEK 6 FWZ 1-10	Baskı 1 - 10	6,0 mm	0518960001	0,400 TL	500
DEK 6 FWZ 11-20	Baskı 11 - 20	6,0 mm	0518960011	0,400 TL	500
DEK 6 FWZ 21-30	Baskı 21 - 30	6,0 mm	0518960021	0,400 TL	500
DEK 6 FWZ 31-40	Baskı 31 - 40	6,0 mm	0518960031	0,400 TL	500
DEK 6 FWZ 41-50	Baskı 41 - 50	6,0 mm	0518960041	0,400 TL	500
DEK 6 FWZ 51-60	Baskı 51 - 60	6,0 mm	0518960051	0,400 TL	500
DEK 6 FWZ 61-70	Baskı 61 - 70	6,0 mm	0518960061	0,400 TL	500
DEK 6 FWZ 71-80	Baskı 71 - 80	6,0 mm	0518960071	0,400 TL	500
DEK 6 FWZ 81-90	Baskı 81 - 90	6,0 mm	0518960081	0,400 TL	500
DEK 6 FWZ 91-100	Baskı 91 - 100	6,0 mm	0518960091	0,400 TL	500
DEK 6 GW +	Baskı +	6,0 mm	1318061198	0,400 TL	500
DEK 6 GW -	Baskı -	6,0 mm	1318061199	0,400 TL	500
DEK 6 GW ERDE	Baskı Toprak	6,0 mm	1318061202	0,400 TL	500
DEK 6 FWZ L1-PE	Baskı L1 - PE	6,0 mm	0631961187	0,400 TL	500
DEK 6 FWZ L1-ERDE I.KRE	Baskı L1	6,0 mm	0631961203	0,400 TL	500
DEK 8					
DEK 8 FWZ 1-10	Baskı 1 - 10	8,0 mm	1276960001	0,440 TL	500
DEK 8 FWZ 11-20	Baskı 11 - 20	8,0 mm	1276960011	0,440 TL	500
DEK 8 FWZ 21-30	Baskı 21 - 30	8,0 mm	1276960021	0,440 TL	500
DEK 8 FWZ 31-40	Baskı 31 - 40	8,0 mm	1276960031	0,440 TL	500
DEK 8 FWZ 41-50	Baskı 41 - 50	8,0 mm	1276960041	0,440 TL	500



PRINTJET ADVANCED 230V



MCP BASIC 2



THM MMP



DEK 5/5 MC NE WS

Tip	Açıklama	Kesit	Sipariş No	Fiyat/Birim	Ambalaj
CLI C - Kapalı - Açık Tip Kablo Markalama					
CLI C Kapalı Tip - PVC, V0 (UL 94), Lazer baskı					
CLI C 02/3	Baskılı	0.20 - 1.50 mm	025211xxxx	0,254 TL	1000
CLI C 02-3 GE NE MP	Baskısız	0.20 - 1.50 mm	0213811687	0,254 TL	200
CLI C 01/3	Baskılı	1.50 - 4.00 mm	025261xxxx	0,254 TL	1000
CLI C 1-3 GE NE MP	Baskısız	1.50 - 4.00 mm	0171111687	0,254 TL	200

Tip	Açıklama	Sipariş No	Fiyat/Birim	Ambalaj
Kablo Markalama Cihazları				
PRINTJET ADVANCED 230V	Inkjet Yazıcı	1324380000	5.400,00 €	1
MCP BASIC 2	A4 Plotter	2438520000	4.050,00 €	1
THM MMP	Multimark yüzeyleri için termal transfer yazıcı	2430920000	2.000,00 €	1

Tip	Açıklama	Sipariş No	Fiyat/Birim	Ambalaj
Cihaz Aksesuarları				
PJ PRO TINTENSET FARBE	PrintJet Pro Renkli Set	1027110000	510,00 €	1
PJ PRO TNTK INK K	PrintJet Pro Siyah mürekkep	1027040000	133,00 €	1
PJ PRO TNTK INK C	PrintJet Pro Mavi mürekkep	1027050000	133,00 €	1
PJ PRO TNTK INK M	PrintJet Pro Kırmızı mürekkep	1027060000	133,00 €	1
PJ PRO TNTK INK Y	PrintJet Pro Sarı mürekkep	1027070000	133,00 €	1
PJ PRO TNAW	PrintJet Pro Atık mürekkep tankı	1024140000	240,00 €	1
PJ ADV TNTK INK SET	PrintJet Advanced Renkli Set	1338720000	564,00 €	1
PJ ADV TNTK INK K	PrintJet Advanced Siyah mürekkep	1338690000	153,75 €	1
PJ ADV TNTK INK C	PrintJet Advanced Mavi mürekkep	1338680000	153,75 €	1
PJ ADV TNTK INK M	PrintJet Advanced Kırmızı mürekkep	1338670000	153,75 €	1
PJ ADV TNTK INK Y	PrintJet Advanced Sarı mürekkep	1338650000	153,75 €	1
PJ ADV TNAW	PrintJet Advanced Atık mürekkep tankı	1338710000	261,50 €	1
MCP AP BASIC	Multikart taşıyıcı - Plotter için	1139880000	636,00 €	1
RIBBON MM 80/360 SW	THM MMP ile uyumlu, Siyah renk, 80 cm genişlik, 360 m uzunluk	2005080000	120,00 €	1
RIBBON MM 110/360 SW	THM MMP ile uyumlu, Siyah renk, 110 cm genişlik, 360 m uzunluk	2005070000	120,00 €	1
RIBBON MM 80/300 WS	THM MMP ile uyumlu, Beyaz Renk, 80 cm genişlik, 360 m uzunluk	2005040000	300,00 €	1
RIBBON MM-TB 25/360 SW	THM MMP ile uyumlu, Siyah Renk, 25 cm genişlik, 360 m uzunluk	2005090000	30,00 €	1
THM MMP CUTTER	Markalama kesme aparatı	1331600000	900,00 €	1
RIBBON THM HIRES	Termal yazıcı için ribon	1790650000	256,00 €	1
RIBBON HSS HF EL 40/300	Termal yazıcı için ribon 40/300 Daralan makaron için	1426210000	143,50 €	1
THM MMP EXT.RH	30 mt. Makoron için Taşıyıcı	1302920000	350,00 €	1
ADAPTER ALU STI-S	STI-S Kalem için	1762440000	46,50 €	1
STI Waterproof schwarz	Silinmez Kalem	0508401694	11,00 €	10

Tip	Ölçü	Sipariş No	Fiyat/Birim	Ambalaj
Klemens Etiketleri - Multikart				
DEK 5/5 MC NE WS	5 / 5 mm	1609801044	0,455 TL	1000
DEK 5/5 PLUS MC NE WS	5 / 5 mm	1854490000	0,455 TL	1000
DEK 5/5 S MC NE WS	5 / 5 mm	1341620000	0,540 TL	400
DEK 5/6 MC NE WS	5 / 6 mm	1609820000	0,456 TL	1000
DEK 5/6.5 MC NE WS	5 / 6,5 mm	1609840000	0,456 TL	900
DEK 5/7.5 MC NE WS	5 / 7,5 mm	1720620000	0,690 TL	320
DEK 5/8 MC NE WS	5 / 8 mm	1856740000	0,466 TL	800
WS 8/5 MC NE WS	8 / 5 mm	1640740000	0,792 TL	720
WS 8/5 PLUS MC NE WS	8 / 5 mm	1951870000	0,801 TL	600
WS 10/5 MC NE WS	10 / 5 mm	1635000000	0,792 TL	720
WS 12/5 MC NE WS	12 / 5 mm	1609860000	0,792 TL	720
WS 10/6 MC NE WS	10 / 6 mm	1828450000	0,792 TL	600
WS 12/6 MC NE WS	12 / 6 mm	1609900000	0,792 TL	600

Serinin devamı sayfa 38



MF 5/5 MC NE WS



SCHT 5 S



WAD 5 MC NE WS



SFC 0/12 MC NE WS

Tip	Ölçü	Sipariş No	Fiyat/Birim	Ambalaj
WS 10/8 PLUS MC NE WS	10 / 8 mm	1905950000	0,810 TL	420
WS 12/8 PLUS MC NE WS	12 / 8 mm	1906000000	0,810 TL	420
WS 10/12 MC NE WS	10 / 12 mm	1905970000	0,810 TL	300
WS 10/15 MC NE WS	10 / 15 mm	1854090000	0,913 TL	240
ZS 10/5 MC NE WS	10 / 5 mm	1610000000	1,04 TL	480
ZS 15/5 MC NE WS	15 / 5 mm	1646630000	1,04 TL	480

Klemens Etiketleri - Diğer Marka Klemensler için Multifit

MF 5/5 MC NE WS	5 / 5 mm	1816250000	0,707 TL	500
MF-W 5/5 MINI MC NE WS	5 / 5 mm	1816240000	0,707 TL	500
MF 8/5 MC NE WS	8 / 5 mm	1677140000	0,894 TL	600
MF 10/5 MC NE WS	10 / 5mm	1677160000	0,894 TL	600
MF 12/5 MC NE WS	12 / 5 mm	1677180000	0,894 TL	600
MF 5/6 MC NE WS	5 / 6 mm	1816260000	0,707 TL	500
MF-W 9/6 MC NE WS	9 / 6 mm	1816290000	0,894 TL	500
MF 10/6 MC NE WS	10 / 6 mm	1677220000	0,894 TL	600

Tip	Açıklama	En / Boy	Sipariş No	Fiyat/Birim	Ambalaj
Klemens Grup Markalama TS 32 ve TS 35					
SCHT 5	Klemens grup markalama	19,5 / 44,5 mm	0292460000	11,05 TL	20
SCHT 5 S	Klemens grup markalama	9,5 / 44,5 mm	1631930000	12,50 TL	20
EM 8/30	Şeffaf, klemens üzerini kaplayan	8 / mm30 mm	1806120000	8,25 TL	50

Tip	Açıklama	En / Renk	Sipariş No	Fiyat/Birim	Ambalaj
Klemens Grup Markalama TS 32 ve TS 35					
ESO 5 DIN A4 WS	SCHT 5 - A4 Kağıt Yazdırma Yüzeyi	60 / Beyaz	1607710000	21,00 TL	10
ESO 5 S DIN A4 WS	SCHT 5 S - A4 Kağıt Yazdırma Yüzeyi	60 / Beyaz	1631920000	21,00 TL	10
ESO 5 P DIN A4 WS	SCHT 5 - A4 Kağıt Yazdırma Yüzeyi	60 / Beyaz	1670370000	225,45 TL	10
ESO 5 P DIN A4 GE	SCHT 5 - A4 Kağıt Yazdırma Yüzeyi	60 / Sarı	1670380000	225,45 TL	10
ESO 5 DIN A4 GE	SCHT 5 - A4 Kağıt Yazdırma Yüzeyi	140 / Sarı	1631350000	21,00 TL	10

Tip	Renk	Ölçü / Adet	Sipariş No	Fiyat/Birim	Ambalaj
WAD Multikard Klemens Grup Etiketleri					
WAD 5 MC NE WS	Beyaz	5 mm / 12 adet	1112910000	2,10 TL	48
WAD 5 MC NE GE	Sarı	5 mm / 12 adet	1112920000	2,10 TL	48
WAD 8 MC NE WS	Beyaz	8 mm / 12 adet	1112940000	2,85 TL	48
WAD 8 MC NE GE	Sarı	8 mm / 12 adet	1112950000	2,85 TL	48
WAD 5 MC B GE/SW	Sarı "Enerji" İşareti baskılı 5 mm	5 mm / 12 adet	1120450000	3,80 TL	48
WAD 8 MC B GE/SW	Sarı "Enerji" İşareti baskılı 8 mm	8 mm / 12 adet	1120470000	3,80 TL	48

Tip	Renk	Kablo Kesit	Sipariş No	Fiyat/Birim	Ambalaj
SlimFix Clip - Çıtırklı Kablo Markalama					
12 mm Uzunluk					
SFC 0/12 MC NE WS	Beyaz / neutral	0,5 - 1,0 mm ²	1813130000	1,11 TL	200
SFC 0/12 MC NE GE	Sarı / neutral	0,5 - 1,0 mm ²	1813160000	1,11 TL	200
SFC 1/12 MC NE WS	Beyaz / neutral	0,75 - 2,5 mm ²	1747320001	1,11 TL	200
SFC 1/12 MC NE GE	Sarı / neutral	0,75 - 2,5 mm ²	1747320004	1,11 TL	200
SFC 2/12 MC NE WS	Beyaz / neutral	2,5 - 4,0 mm ²	1758320001	1,23 TL	120
SFC 2/12 MC NE GE	Sarı / neutral	2,5 - 4,0 mm ²	1758320004	1,23 TL	120
SFC 2.5/12 MC NE WS	Beyaz / neutral	4,0 - 6,0 mm ²	1062000000	1,49 TL	120
SFC 2.5/12 MC NE GE	Sarı / neutral	4,0 - 6,0 mm ²	1062010000	1,49 TL	120
SFC 3/12 MC NE WS	Beyaz / neutral	4,0 - 10,0 mm ²	1025220000	1,69 TL	80
SFC 3/12 MC NE GE	Sarı / neutral	4,0 - 10,0 mm ²	1025230000	1,69 TL	80

Tip	Renk	Kablo Kesit	Sipariş No	Fiyat/Birim	Ambalaj
21 mm Uzunluk					
SFC 0/21 MC NE WS	Beyaz / neutral	0,5 - 1,0 mm ²	1813190000	1,23 TL	200
SFC 0/21 MC NE GE	Sarı / neutral	0,5 - 1,0 mm ²	1813210000	1,23 TL	200
SFC 1/21 MC NE WS	Beyaz / neutral	0,75 - 2,5 mm ²	1779080001	1,23 TL	200
SFC 1/21 MC NE GE	Sarı / neutral	0,75 - 2,5 mm ²	1779080004	1,23 TL	200
SFC 2/21 MC NE WS	Beyaz / neutral	2,5 - 4,0 mm ²	1805810000	1,35 TL	120
SFC 2/21 MC NE GE	Sarı / neutral	2,5 - 4,0 mm ²	1805780000	1,35 TL	120
SFC 2.5/21 MC NE WS	Beyaz / neutral	4,0 - 6,0 mm ²	1062050000	1,62 TL	120
SFC 2.5/21 MC NE GE	Sarı / neutral	4,0 - 6,0 mm ²	1062070000	1,62 TL	120
SFC 3/21 MC NE WS	Beyaz / neutral	4,0 - 10,0 mm ²	1025260000	1,89 TL	80
SFC 3/21 MC NE GE	Sarı / neutral	4,0 - 10,0 mm ²	1025270000	1,89 TL	80
30 mm Uzunluk					
SFC 0/30 MC NE WS	Beyaz / neutral	0,5 - 1,0 mm ²	1813240000	1,25 TL	150
SFC 0/30 MC NE GE	Sarı / neutral	0,5 - 1,0 mm ²	1813260000	1,25 TL	150
SFC 1/30 MC NE WS	Beyaz / neutral	0,75 - 2,5 mm ²	1805760000	1,25 TL	150
SFC 1/30 MC NE GE	Sarı / neutral	0,75 - 2,5 mm ²	1805730000	1,25 TL	150
SFC 2/30 MC NE WS	Beyaz / neutral	2,5 - 4,0 mm ²	1805870000	1,42 TL	90
SFC 2/30 MC NE GE	Sarı / neutral	2,5 - 4,0 mm ²	1805830000	1,42 TL	90
SFC 3/30 MC NE WS	Beyaz / neutral	4,0 - 10,0 mm ²	1025310000	2,10 TL	60
SFC 3/30 MC NE GE	Sarı / neutral	4,0 - 10,0 mm ²	1025320000	2,10 TL	60
SlimFix V2 - Kavramalı ve Geçmeli Tip Kablo Markalama					
12 mm Uzunluk					
SF 00/12 MC NE WS V2	Beyaz / neutral	< 0,25 mm ²	1919290000	1,04 TL	400
SF 00/12 MC NE GE V2	Sarı / neutral	< 0,25 mm ²	1919260000	1,04 TL	400
SF 0/12 MC NE WS V2	Beyaz / neutral	0,25 - 0,5 mm ²	1919240000	1,12 TL	400
SF 0/12 MC NE GE V2	Sarı / neutral	0,25 - 0,5 mm ²	1919210000	1,12 TL	400
SF 1/12 MC NE WS V2	Beyaz / neutral	0,5 - 0,75 mm ²	1919390000	1,12 TL	400
SFR 1/12 MC NE WS	Beyaz / neutral	0,5 - 0,75 mm ²	1318640000	1,35 TL	400
SF 1/12 MC NE GE V2	Sarı / neutral	0,5 - 0,75 mm ²	1919340000	1,12 TL	400
SFR 1/12 MC NE GE	Sarı / neutral	0,5 - 0,75 mm ²	1318650000	1,42 TL	400
SF 2/12 MC NE WS V2	Beyaz / neutral	0,75 - 1,5 mm ²	1919490000	1,20 TL	400
SFR 2/12 MC NE WS	Beyaz / neutral	0,75 - 1,5 mm ²	1318660000	1,49 TL	400
SF 2/12 MC NE GE V2	Sarı / neutral	0,75 - 1,5 mm ²	1919470000	1,20 TL	400
SFR 2/12 MC NE GE	Sarı / neutral	0,75 - 1,5 mm ²	1318670000	1,49 TL	400
SF 3/12 MC NE WS V2	Beyaz / neutral	1,5 - 2,5 mm ²	1919540000	1,25 TL	320
SFR 3/12 MC NE WS	Beyaz / neutral	1,5 - 2,5 mm ²	1318680000	1,55 TL	256
SF 3/12 MC NE GE V2	Sarı / neutral	1,5 - 2,5 mm ²	1919520000	1,26 TL	320
SFR 3/12 MC NE GE	Sarı / neutral	1,5 - 2,5 mm ²	1318690000	1,62 TL	256
SF 4/12 MC NE WS V2	Beyaz / neutral	2,5 - 4,0 mm ²	1919600000	1,30 TL	128
SF 4/12 MC NE GE V2	Sarı / neutral	2,5 - 4,0 mm ²	1919580000	1,30 TL	128
SF 5/12 MC NE WS V2	Beyaz / neutral	6,0 - 10,0 mm ²	1919650000	1,69 TL	160
SF 5/12 MC NE GE V2	Sarı / neutral	6,0 - 10,0 mm ²	1919620000	1,69 TL	160
21 mm Uzunluk					
SF 00/21 MC NE WS V2	Beyaz / neutral	< 0,25 mm ²	1918580000	1,04 TL	400
SF 00/21 MC NE GE V2	Sarı / neutral	< 0,25 mm ²	1918560000	1,04 TL	400
SF 0/21 MC NE WS V2	Beyaz / neutral	0,25 - 0,5 mm ²	1918500000	1,12 TL	400
SF 0/21 MC NE GE V2	Sarı / neutral	0,25 - 0,5 mm ²	1918480000	1,12 TL	400
SF 1/21 MC NE WS V2	Beyaz / neutral	0,5 - 0,75 mm ²	1918630000	1,20 TL	400
SFR 1/21 MC NE WS	Beyaz / neutral	0,5 - 0,75 mm ²	1318710000	1,49 TL	400
SF 1/21 MC NE GE V2	Sarı / neutral	0,5 - 0,75 mm ²	1918610000	1,20 TL	400

Serinin devamı sayfa 40



SFX 10/23 MC NE WS V2



SF-TOOL 00-6



TM-I 12 MC NE WS

Tip	Renk	Kablo Kesit	Sipariş No	Fiyat/Birim	Ambalaj
SFR 1/21 MC NE GE	Sarı / neutral	0,5 - 0,75 mm ²	1318720000	1,49 TL	400
SF 2/21 MC NE WS V2	Beyaz / neutral	0,75 - 1,5 mm ²	1918690000	1,26 TL	400
SFR 2/21 MC NE WS	Beyaz / neutral	0,75 - 1,5 mm ²	1318730000	1,55 TL	400
SF 2/21 MC NE GE V2	Sarı / neutral	0,75 - 1,5 mm ²	1918660000	1,26 TL	400
SFR 2/21 MC NE GE	Sarı / neutral	0,75 - 1,5 mm ²	1318740000	1,55 TL	400
SF 3/21 MC NE WS V2	Beyaz / neutral	1,5 - 2,5 mm ²	1918910000	1,35 TL	320
SFR 3/21 MC NE WS	Beyaz / neutral	1,5 - 2,5 mm ²	1318750000	1,62 TL	256
SF 3/21 MC NE GE V2	Sarı / neutral	1,5 - 2,5 mm ²	1918890000	1,35 TL	320
SFR 3/21 MC NE GE	Sarı / neutral	1,5 - 2,5 mm ²	1318760000	1,55 TL	256
SF 4/21 MC NE WS V2	Beyaz / neutral	2,5 - 4,0 mm ²	1919080000	1,35 TL	192
SF 4/21 MC NE GE V2	Sarı / neutral	2,5 - 4,0 mm ²	1919060000	1,35 TL	192
SF 4.5/21 MC NE WS V2	Beyaz / neutral	4,0 - 6,0 mm ²	1919020000	1,96 TL	96
SF 4.5/21 MC NE GE V2	Sarı / neutral	4,0 - 6,0 mm ²	1919000000	1,96 TL	96
SF 5/21 MC NE WS V2	Beyaz / neutral	6,0 - 10,0 mm ²	1919140000	2,30 TL	160
SF 5/21 MC NE GE V2	Sarı / neutral	6,0 - 10,0 mm ²	1919120000	2,30 TL	160
SF 6/21 MC NE WS V2	Beyaz / neutral	10,0 - 16,0 mm ²	1919190000	2,95 TL	160
SF 6/21 MC NE GE V2	Sarı / neutral	10,0 - 16,0 mm ²	1919170000	2,95 TL	160

SFX Kablo Bağı ile montaj

SFX 10/23 MC NE WS V2	Beyaz / neutral	16,0 mm ²	1852390000	4,05 TL	160
SFX 10/23 MC NE GE V2	Sarı / neutral	16,0 mm ²	1852360000	4,05 TL	160
SFX 14/23 MC NE WS V2	Beyaz / neutral	16,0 mm ²	1852440000	4,05 TL	160
SFX 14/23 MC NE GE V2	Sarı / neutral	16,0 mm ²	1852410000	4,05 TL	160
SFX 9/24 MC NE WS V2	Beyaz / neutral	16,0 mm ²	1852490000	4,05 TL	160
SFX 9/24 MC NE GE V2	Sarı / neutral	16,0 mm ²	1852460000	4,05 TL	160
SFX 11/60 MC NE WS	Beyaz / neutral	16,0 mm ²	1860120000	4,05 TL	60
SFX 11/60 MC NE GE	Sarı / neutral	16,0 mm ²	1860150000	4,05 TL	60
SFX 30/60 MC NE WS	Beyaz / neutral	40 mm ² ve üstü ölçüler için	1083230000	4,30 TL	30
SFX 30/60 MC NE GE	Sarı / neutral	40 mm ² ve üstü ölçüler için	1083240000	4,30 TL	30

Tip	Açıklama	Sipariş No	Fiyat/Birim	Ambalaj
SF - TOOL				
SF-TOOL 00-6	SlimFix	1950820000	0,50 €	10
SF-TOOL 1	SlimFix	1782970000	0,75 €	10
SF-TOOL 2-3	SlimFix	1782960000	0,75 €	10
SF-TOOL 4-5	SlimFix	1782980000	0,75 €	10

Tip	Renk	Sipariş No	Fiyat/Birim	Ambalaj
TM-I - Etiket				
TM-I 12 MC NE WS	Beyaz	1718411044	1,00 TL	320
TM-I 12 MC NE GE	Sarı	1718411687	1,00 TL	320
TM-I 15 MC NE WS	Beyaz	1609981044	1,03 TL	400
TM-I 15 MC NE GE	Sarı	1609981687	1,03 TL	400
TM-I 18 MC NE WS	Beyaz	1718431044	1,12 TL	320
TM-I 18 MC NE GE	Sarı	1718431687	1,12 TL	320
TM-I 20 MC NE WS	Beyaz	1680411044	1,12 TL	400
TM-I 20 MC NE GE	Sarı	1680411687	1,12 TL	400
TM-I 30 MC NE WS	Beyaz	1876390000	1,12 TL	300
TM-I 30 MC NE GE	Sarı	1876370000	1,12 TL	300



TM 201/12 VO



TM 201/18 VO

Tip	Uzunluk	Kablo Kesit	Sipariş No	Fiyat/Birim	Ambalaj
TM Şeffaf Kılıflar					
TM 201/12 VO	12 mm	1.5 - 2.5 mm	1798640000	0,234 TL	1000
TM 201/15 VO	15 mm	1.5 - 2.5 mm	1798620000	0,234 TL	1000
TM 201/18 VO	18 mm	1.5 - 2.5 mm	1798600000	0,327 TL	1000
TM 201/20 VO	20 mm	1.5 - 2.5 mm	1798580000	0,327 TL	1000
TM 201/30 VO	30 mm	1.5 - 2.5 mm	1874850000	0,439 TL	500
TM 202/12 VO	12 mm	2 - 4 mm	1798560000	0,251 TL	1000
TM 202/15 VO	15 mm	2 - 4 mm	1798540000	0,251 TL	1000
TM 202/18 VO	18 mm	2 - 4 mm	1798530000	0,344 TL	1000
TM 202/20 VO	20 mm	2 - 4 mm	1798520000	0,344 TL	1000
TM 202/30 VO	30 mm	2 - 4 mm	1874760000	0,513 TL	500
TM 203/12 VO	12 mm	4 - 7 mm	1798510000	0,298 TL	500
TM 203/15 VO	15 mm	4 - 7 mm	1798490000	0,298 TL	500
TM 203/18 VO	18 mm	4 - 7 mm	1798480000	0,428 TL	500
TM 203/20 VO	20 mm	4 - 7 mm	1798470000	0,428 TL	500
TM 203/30 VO	30 mm	4 - 7 mm	1874770000	0,662 TL	200
TM 204/12 VO	12 mm	6 - 10 mm	1806180000	0,354 TL	500
TM 204/15 VO	15 mm	6 - 10 mm	1806240000	0,354 TL	500
TM 204/18 VO	18 mm	6 - 10 mm	1806300000	0,504 TL	500
TM 204/20 VO	20 mm	6 - 10 mm	1806360000	0,504 TL	500
TM 204/30 VO	30 mm	6 - 10 mm	1874780000	0,857 TL	200
TM 205/12 VO	12 mm	10 - 14 mm	1806190000	0,718 TL	200
TM 205/15 VO	15 mm	10 - 14 mm	1806250000	0,950 TL	200
TM 205/18 VO	18 mm	10 - 14 mm	1806310000	1,04 TL	200
TM 205/20 VO	20 mm	10 - 14 mm	1806370000	1,10 TL	200
TM 205/30 VO	30 mm	10 - 14 mm	1874790000	1,80 TL	200
CLI T Şeffaf Kılıflar					
CLI T 02-12	12 mm	1,3 - 3 mm	1764060000	0,298 TL	200
CLI T 02-15	15 mm	1,3 - 3 mm	1764070000	0,298 TL	200
CLI T 02-18	18 mm	1,3 - 3 mm	1764140000	0,298 TL	200
CLI T 02-20	20 mm	1,3 - 3 mm	1764150000	0,401 TL	200
CLI T 02-30	30 mm	1,3 - 3 mm	1889580000	0,401 TL	200
CLI T 1-12	12 mm	2.5 - 5 mm	1764190000	0,327 TL	200
CLI T 1-15	15 mm	2.5 - 5 mm	1764200000	0,327 TL	200
CLI T 1-18	18 mm	2.5 - 5 mm	1764210000	0,327 TL	200
CLI T 1-20	20 mm	2.5 - 5 mm	1764220000	0,475 TL	200
CLI T 1-30	30 mm	2.5 - 5 mm	1889560000	0,475 TL	200
CLI T 2-12	12 mm	4 - 10 mm	1764230000	0,745 TL	100
CLI T 2-15	15 mm	4 - 10 mm	1764240000	0,745 TL	100
CLI T 2-18	18 mm	4 - 10 mm	1764250000	0,745 TL	100
CLI T 2-20	20 mm	4 - 10 mm	1764260000	0,745 TL	100
CLI T 2-30	30 mm	4 - 10 mm	1889570000	1,09 TL	100
CLI T 3-12	12 mm	8 - 16 mm	1764270000	1,42 TL	100
CLI T 3-15	15 mm	8 - 16 mm	1764280000	1,42 TL	100
CLI T 3-18	18 mm	8 - 16 mm	1764290000	1,42 TL	100
CLI T 3-20	20 mm	8 - 16 mm	1764300000	1,42 TL	100
CLI T 3-30	30 mm	8 - 16 mm	1889550000	1,42 TL	100
DMC 12/27 - Kablo Markalama					
DMC 12/27 MC NE WS	12,0 x 27,0 mm	0,5 - 10,0 mm ²	1016030000	2,10 TL	50
DMC 12/27 MC NE GE	12,0 x 27,0 mm	0,5 - 10,0 mm ²	1018190000	2,10 TL	50



CLI T 02-12



DMC 12/27 MC NE WS



SM 27/8 MC NE WS



SM 27/18 K MC NE WS



CC 15/17 MC NE WS

Tip	Renk	Açıklama	Sipariş No	Fiyat/Birim	Ambalaj
SwitchMark SM - Push Butonlar İçin					
SM 27/8 MC NE WS	Beyaz	Yapışkansız	1699820000	3,25 TL	80
SM 27/8 MC NE SI	Gri	Yapışkansız	1713680000	3,25 TL	80
SM 27/8 K MC NE WS	Beyaz	Yapışkanlı	1812630000	6,00 TL	80
SM 27/8 K MC NE SI	Gri	Yapışkanlı	1771930000	6,00 TL	80
SM 27/12.5 MC NE WS	Beyaz	Yapışkansız	1699840000	3,50 TL	80
SM 27/12.5 MC NE SI	Gri	Yapışkansız	1713700000	3,50 TL	80
SM 27/12.5 K MC NE WS	Beyaz	Yapışkanlı	1699880000	5,80 TL	80
SM 27/12.5 K MC NE SI	Gri	Yapışkanlı	1713720000	5,80 TL	80
SM-H 27/12.5 SW	Siyah	Taşıyıcı	1716640000	4,40 TL	25
SM 27/18 MC NE WS	Beyaz	Yapışkansız	1699860000	3,70 TL	80
SM 27/18 MC NE SI	Gri	Yapışkansız	1713740000	3,70 TL	80
SM 27/18 K MC NE WS	Beyaz	Yapışkanlı	1707270000	5,80 TL	80
SM 27/18 K MC NE SI	Gri	Yapışkanlı	1713760000	5,80 TL	80
SM-H 27/18 SW	Siyah	Taşıyıcı	1716630000	4,50 TL	25
SM 27/27 MC NE WS	Beyaz	Yapışkansız	1773220000	3,70 TL	60
SM 27/27 MC NE SI	Gümüş	Yapışkansız	1773230000	3,70 TL	60
SM 27/27 K MC NE WS	Beyaz	Yapışkanlı	1783000000	5,80 TL	60
SM 27/27 K MC NE SI	Gri	Yapışkanlı	1782990000	5,80 TL	60
SM-H 27/27 SW	Siyah	Taşıyıcı	1782710000	4,70 TL	10
SM 18/9.5 K MC NE WS	Beyaz	Yapışkanlı	1248580000	5,60 TL	200
SM 18/9.5 K MC NE GE	Sarı	Yapışkanlı	1248590000	5,60 TL	200
SM 18/9.5 K MC NE GR	Gri	Yapışkanlı	1248610000	5,60 TL	200
SM 19/42 K MC NE WS	Beyaz	Yapışkanlı	1248620000	7,70 TL	40
SM 19/42 K MC NE GE	Sarı	Yapışkanlı	1248630000	7,70 TL	40
SM 19/42 K MC NE GR	Gri	Yapışkanlı	1248640000	7,70 TL	40
SM 45/45-24 MC NE WS	Beyaz	Yapışkansız	1248650000	11,20 TL	20
SM 45/45-24 MC NE GE	Sarı	Yapışkansız	1248660000	11,20 TL	20
SM 45/45-24 MC NE GR	Gri	Yapışkansız	1248670000	11,20 TL	20
ClipCard Multikartları					
CC 15/17 MC NE WS	Beyaz	Yapışkansız	1876570000	2,50 TL	80
CC 15/17 MC NE SI	Gri	Yapışkansız	1876610000	2,50 TL	80
CC 15/17 K MC NE WS	Beyaz	Yapışkanlı	1876590000	2,70 TL	80
CC 15/17 K MC NE SI	Gri	Yapışkanlı	1876580000	2,70 TL	80
CC-H 15/17	Siyah	Taşıyıcı	1790430000	6,95 TL	75
CC 15/27 MC NE WS	Beyaz	Yapışkansız	1876770000	2,70 TL	80
CC 15/27 MC NE SI	Gri	Yapışkansız	1876760000	2,70 TL	80
CC 15/27 K MC NE WS	Beyaz	Yapışkanlı	1876640000	2,95 TL	80
CC 15/27 K MC NE SI	Gri	Yapışkanlı	1876780000	2,95 TL	80
CC-H 15/27	Siyah	Taşıyıcı	1790410000	7,20 TL	45
CC 15/49 MC NE WS	Beyaz	Yapışkansız	1877260000	2,95 TL	40
CC 15/49 MC NE SI	Gri	Yapışkansız	1877240000	2,95 TL	40
CC 15/49 K MC NE WS	Beyaz	Yapışkanlı	1877220000	3,70 TL	40
CC 15/49 K MC NE SI	Gri	Yapışkanlı	1877270000	3,70 TL	40
CC-H 15/49	Siyah	Taşıyıcı	1790420000	7,85 TL	25
CC 15/60 MC NE WS	Beyaz	Yapışkansız	1877350000	3,40 TL	40
CC 15/60 MC NE SI	Gri	Yapışkansız	1877340000	3,40 TL	40
CC 15/60 K MC NE WS	Beyaz	Yapışkanlı	1877310000	3,90 TL	40
CC 15/60 K MC NE SI	Gri	Yapışkanlı	1877360000	3,90 TL	40
CC-H 15/60	Siyah	Taşıyıcı	1878910000	8,85 TL	25
CC 30/60 MC NE WS	Beyaz	Yapışkansız	1934420000	3,70 TL	30

Serinin devamı sayfa 43

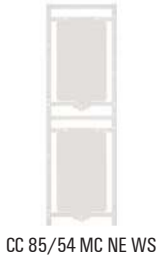

CC 85/54 MC NE WS

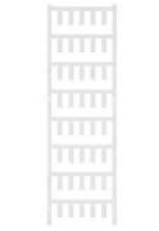

ESG 6/15 K MC NE WS



CC-M 85/54 AL



CC-M DIA 30 AL

Tip	Renk	Açıklama	Sipariş No	Fiyat/Birim	Ambalaj
CC 30/60 MC NE SI	Gri	Yapışkansız	1934400000	3,70 TL	30
CC 30/60 K MC NE WS	Beyaz	Yapışkanlı	1934390000	3,90 TL	30
CC 30/60 K MC NE SI	Gri	Yapışkanlı	1934330000	3,90 TL	30
CC-H 30/60	Siyah	Taşıyıcı	1934430000	9,30 TL	10
CC 85/54 MC NE WS	Beyaz	Yapışkansız	1138400000	15,45 TL	10
CC 85/54 MC NE GR	Gri	Yapışkansız	1138420000	15,45 TL	10
CC 85/54 K MC NE WS	Beyaz	Yapışkanlı	1138430000	18,10 TL	10
CC 85/54 K MC NE GR	Gri	Yapışkanlı	1138450000	18,10 TL	10

ESG Cihaz Markalama - Multikart

ESG 6/15 K MC NE WS	Beyaz	Yapışkanlı	1880100000	2,00 TL	200
ESG 6/15 K MC NE GE	Sarı	Yapışkanlı	1880130000	3,30 TL	200
ESG 6/15 RIDER MC NE WS	Beyaz	Yapışkanlı	1881280000	0,597 TL	200
ESG 6/17 K MC NE WS	Beyaz	Yapışkanlı	1880120000	2,00 TL	200
ESG 6/17 K MC NE GE	Sarı	Yapışkanlı	1880110000	2,00 TL	200
ESG 7/20 SIRIUS MC NE WS	Beyaz	Yapışkansız	1736181044	1,76 TL	200
ESG 7/20 SIRIUS MC NE TU	Turkuaz	Yapışkansız	1736181696	1,76 TL	200
ESG 8/17 MC NE WS	Beyaz	Yapışkansız	1674740000	1,62 TL	200
ESG 9/11 K MC NE WS	Beyaz	Yapışkanlı	1857440000	2,10 TL	200
ESG 9/17 K MC NE WS	Beyaz	Yapışkanlı	1674760000	2,70 TL	200
ESG 9/17 K MC NE GE	Sarı	Yapışkanlı	1753500000	2,35 TL	200
ESG 9/20 MC NE WS	Beyaz	Yapışkansız	1609940000	1,69 TL	200
ESG 9/20 MC NE TK	Turkuaz	Yapışkansız	1866690000	1,69 TL	200

Tip	Açıklama	Sipariş No	Fiyat/Birim	Ambalaj
-----	----------	------------	-------------	---------

Metal Markalama

CC-M 85/54 AL	Alüminyum Metal Kart	1327600000	47,70 TL	40
CC-M 85/54 ST	Paslanmaz Çelik Metal Kart	1327620000	71,70 TL	40
CC-M 27/18 AL	Alüminyum Metal Kart	1327630000	9,45 TL	200
CC-M 27/18 ST	Paslanmaz Çelik Metal Kart	1327640000	13,25 TL	200
CC-M 85/27 AL	Alüminyum Metal Kart	1327650000	29,85 TL	80
CC-M 85/27 ST	Paslanmaz Çelik Metal Kart	1327670000	38,40 TL	80
CC-M 30/60 ST	Paslanmaz Çelik Metal Kart	1327690000	29,45 TL	100
CC-M 15/60 AL	Alüminyum Metal Kart	1327700000	11,70 TL	200
CC-M 15/60 ST	Paslanmaz Çelik Metal Kart	1327720000	16,25 TL	200
CC-M 15/45 AL	Alüminyum Metal Kart	1327730000	9,70 TL	200
CC-M 15/45 ST	Paslanmaz Çelik Metal Kart	1327740000	14,30 TL	200
CC-M DIA 30 AL	Alüminyum Metal Kart	1327750000	11,70 TL	200
CC-M DIA 30 ST	Paslanmaz Çelik Metal Kart	1327770000	15,45 TL	200
SFX-M 11/60 AL	Alüminyum Metal Kart - Kablo Markalaması	1327780000	14,30 TL	50
SFX-M 11/60 ST	Paslanmaz Çelik Metal Kart - Kablo Markalaması	1327790000	17,90 TL	50
CC-M 85/54 4X3 AL	Üzerinde 4 Adet Puntolama Deliği Olan Alüminyum Tip	1327800000	47,70 TL	40
CC-M 85/54 4X3 ST	Üzerinde 4 Adet Puntolama Deliği Olan Paslanmaz Çelik Tip	1327820000	71,70 TL	40
CC-M 85/27 2X3 AL	Üzerinde 2 Adet Puntolama Deliği Olan Alüminyum Tip	1327830000	29,85 TL	80
CC-M 85/27 2X3 ST	Üzerinde 2 Adet Puntolama Deliği Olan Paslanmaz Çelik Tip	1327840000	38,40 TL	80
CC-M 30/60 2X3 AL	Üzerinde 2 Adet Puntolama Deliği Olan Alüminyum Tip	1327850000	23,35 TL	100
CC-M 30/60 2X3 ST	Üzerinde 2 Adet Puntolama Deliği Olan Paslanmaz Çelik Tip	1327870000	29,45 TL	100
CC-M 15/60 2X3 AL	Üzerinde 2 Adet Puntolama Deliği Olan Alüminyum Tip	1327880000	11,70 TL	200
CC-M 15/60 2X3 ST	Üzerinde 2 Adet Puntolama Deliği Olan Paslanmaz Çelik Tip	1327890000	16,25 TL	200
CC-M 15/45 2X3 AL	Üzerinde 2 Adet Puntolama Deliği Olan Alüminyum Tip	1327900000	9,70 TL	200
CC-M 15/45 2X3 ST	Üzerinde 2 Adet Puntolama Deliği Olan Paslanmaz Çelik Tip	1327920000	14,30 TL	200
DKB CC 85/54	Metal Kartlar İçin Yapışkanlı Bant	1175850000	13,65 TL	100

Serinin devamı sayfa 44



DKB CC 27/18



INLAY CC-M 15/45



THM MT30X 15/6 WS



THM GEW 15/6 GE



DEK 5/3.5 MM WS

Tip	Açıklama	Sipariş No	Fiyat/Birim	Ambalaj
DKB CC 85/27	Metal Kartlar İçin Yapışkanlı Bant	1226620000	10,65 TL	100
CC-M 30/60 AL	Alüminyum Metal Kart	1327680000	23,35 TL	100
DKB CC 30/60	Metal Kartlar İçin Yapışkanlı Bant	1341130000	4,45 TL	100
DKB CC 27/18	Metal Kartlar İçin Yapışkanlı Bant	1341140000	1,89 TL	320
DKB CC 15/60	Metal Kartlar İçin Yapışkanlı Bant	1341150000	3,30 TL	160
DKB CC 15/45	Metal Kartlar İçin Yapışkanlı Bant	1341170000	2,70 TL	240
DKB CC DIA 30	Metal Kartlar İçin Yapışkanlı Bant	1341180000	2,85 TL	200
INLAY CC-M 85/54	Metal Kartlar İçin Taşıyıcı Aparat	1341030000	1.335,00 TL	1
INLAY CC-M 27/18	Metal Kartlar İçin Taşıyıcı Aparat	1341040000	1.335,00 TL	1
INLAY CC-M 85/27	Metal Kartlar İçin Taşıyıcı Aparat	1341050000	1.335,00 TL	1
INLAY CC-M 30/60	Metal Kartlar İçin Taşıyıcı Aparat	1341070000	1.335,00 TL	1
INLAY CC-M 15/60	Metal Kartlar İçin Taşıyıcı Aparat	1341080000	1.335,00 TL	1
INLAY CC-M 15/45	Metal Kartlar İçin Taşıyıcı Aparat	1341090000	1.335,00 TL	1
INLAY CC-M DIA 30	Metal Kartlar İçin Taşıyıcı Aparat	1341100000	1.335,00 TL	1
INLAY SFX-M 11/60	Metal Kartlar İçin Taşıyıcı Aparat	1341110000	1.335,00 TL	1
INLAY CC-M UNIVERSAL	Metal Kartlar İçin Taşıyıcı Aparat	1341120000	2.002,00 TL	1

Tip	Açıklama	Renk / Materyal	Sipariş No	Fiyat/Birim	Ambalaj
THM - Cihaz ve İletken Markalaması					
THM MT30X 15/6 WS	10.000 / Rulo	Beyaz - Polyester Film	1753231044	2.543,00 TL	1
THM MT30X 15/6 GE	10.000 / Rulo	Sarı - Polyester Film	1753231687	2.543,00 TL	1
THM MT30X 17/9 WS	10.000 / Rulo	Beyaz - Polyester Film	1968130000	2.777,00 TL	1
THM MT30X 17/9 GE	10.000 / Rulo	Sarı - Polyester Film	1856650000	2.777,00 TL	1
THM MT30X 20/8 WS	10.000 / Rulo	Beyaz - Polyester Film	1753241044	2.543,00 TL	1
THM MT30X 20/8 GE	10.000 / Rulo	Sarı - Polyester Film	1753241687	2.543,00 TL	1
THM MT30X 25/12 WS	10.000 / Rulo	Beyaz - Polyester Film	1751751044	4.173,00 TL	1
THM MT30X 25/12 GE	10.000 / Rulo	Sarı - Polyester Film	1751751687	4.173,00 TL	1
THM MT30X 45/23 WS	2.000 / Rulo	Beyaz - Polyester Film	1751811044	1.715,00 TL	1
THM MT30X 45/23 GE	2.000 / Rulo	Sarı - Polyester Film	1751811687	1.715,00 TL	1
THM MT30X 65/35 WS	1.000 / Rulo	Beyaz - Polyester Film	1751831044	1.976,00 TL	1
THM MT30X 65/35 GE	1.000 / Rulo	Sarı - Polyester Film	1751831687	1.976,00 TL	1
THM GEW 15/6 WS	10.000 / Rulo	Beyaz - Tekstil Kağıdı	1059780000	3.140,00 TL	1
THM GEW 15/6 GE	10.000 / Rulo	Sarı - Tekstil Kağıdı	1059790000	3.140,00 TL	1
THM GEW 17/9 WS	10.000 / Rulo	Beyaz - Tekstil Kağıdı	1059800000	3.140,00 TL	1
THM GEW 17/9 GE	10.000 / Rulo	Sarı - Tekstil Kağıdı	1059810000	3.140,00 TL	1
THM GEW 20/8 WS	10.000 / Rulo	Beyaz - Tekstil Kağıdı	1059870000	3.140,00 TL	1
THM GEW 20/8 GE	10.000 / Rulo	Sarı - Tekstil Kağıdı	1059880000	3.140,00 TL	1

Tip	Renk	Birlikte Kullanılacak Ribon	Sipariş No	Fiyat/Birim	Ambalaj
Multimark Etiket Grupları					
Klemens Markalama DEK, WS					
DEK 5/3.5 MM WS	Beyaz	RIBBON MM-TB 25/360 SW	2007100000	0,251 TL	1000
DEK 5/5 MM WS	Beyaz	RIBBON MM-TB 25/360 SW	2007110000	0,261 TL	800
DEK 5/6 MM WS	Beyaz	RIBBON MM-TB 25/360 SW	2007120000	0,261 TL	600
DEK 5/8 MM WS	Beyaz	RIBBON MM-TB 25/360 SW	2007130000	0,261 TL	500
WS 8/3.5 MM WS	Beyaz	RIBBON MM-TB 25/360 SW	2007140000	0,306 TL	1000
WS 8/5 MM WS	Beyaz	RIBBON MM-TB 25/360 SW	2007150000	0,311 TL	800
WS 8/6 MM WS	Beyaz	RIBBON MM-TB 25/360 SW	2007160000	0,327 TL	600
WS 8/8 MM WS	Beyaz	RIBBON MM-TB 25/360 SW	2007170000	0,344 TL	500
WS 12/3.5 MM WS	Beyaz	RIBBON MM-TB 25/360 SW	2007180000	0,327 TL	1000
WS 12/5 MM WS	Beyaz	RIBBON MM-TB 25/360 SW	2007190000	0,339 TL	800
WS 12/6 MM WS	Beyaz	RIBBON MM-TB 25/360 SW	2007200000	0,344 TL	600
WS 12/8 MM WS	Beyaz	RIBBON MM-TB 25/360 SW	2007210000	0,373 TL	500

Tip	Renk	Birlikte Kullanılacak Ribon	Sipariş No	Fiyat/Birim	Ambalaj
Kablo Markalama TM-I					
TM-I 12 MM BL	Mavi	RIBBON MM 80/360 SW	2005890000	0,587 TL	2000
TM-I 12 MM GE	Sarı	RIBBON MM 80/360 SW	2005550000	0,587 TL	2000
TM-I 12 MM RT	Kırmızı	RIBBON MM 80/360 SW	2005730000	0,587 TL	2000
TM-I 12 MM WS	Beyaz	RIBBON MM 80/360 SW	2005440000	0,587 TL	2000
TM-I 15 MM BL	Mavi	RIBBON MM 80/360 SW	2005910000	0,624 TL	2000
TM-I 15 MM GE	Sarı	RIBBON MM 80/360 SW	2005580000	0,624 TL	2000
TM-I 15 MM RT	Kırmızı	RIBBON MM 80/360 SW	2005760000	0,624 TL	2000
TM-I 15 MM WS	Beyaz	RIBBON MM 80/360 SW	2005450000	0,624 TL	2000
TM-I 18 MM BL	Mavi	RIBBON MM 80/360 SW	2005930000	0,662 TL	2000
TM-I 18 MM GE	Sarı	RIBBON MM 80/360 SW	2005610000	0,662 TL	2000
TM-I 18 MM RT	Kırmızı	RIBBON MM 80/360 SW	2005790000	0,662 TL	2000
TM-I 18 MM WS	Beyaz	RIBBON MM 80/360 SW	2005470000	0,662 TL	2000
TM-I 20 MM BL	Mavi	RIBBON MM 80/360 SW	2005950000	0,690 TL	2000
TM-I 20 MM GE	Sarı	RIBBON MM 80/360 SW	2005640000	0,690 TL	2000
TM-I 20 MM RT	Kırmızı	RIBBON MM 80/360 SW	2005820000	0,690 TL	2000
TM-I 20 MM WS	Beyaz	RIBBON MM 80/360 SW	2005490000	0,690 TL	2000
TM-I 23 MM BL	Mavi	RIBBON MM 80/360 SW	2005970000	0,717 TL	2000
TM-I 23 MM GE	Sarı	RIBBON MM 80/360 SW	2005670000	0,717 TL	2000
TM-I 23 MM RT	Kırmızı	RIBBON MM 80/360 SW	2005850000	0,717 TL	2000
TM-I 23 MM WS	Beyaz	RIBBON MM 80/360 SW	2005510000	0,717 TL	2000
TM-I 30 MM BL	Mavi	RIBBON MM 80/360 SW	2005990000	0,783 TL	2000
TM-I 30 MM GE	Sarı	RIBBON MM 80/360 SW	2005700000	0,783 TL	2000
TM-I 30 MM RT	Kırmızı	RIBBON MM 80/360 SW	2005870000	0,783 TL	2000
TM-I 30 MM WS	Beyaz	RIBBON MM 80/360 SW	2005530000	0,783 TL	2000
Kablo Markalama WM					
WM 0/12 1.0-2.0 MM GE	Sarı - 0.5 - 0.75 mm ²	RIBBON MM 80/360 SW	2006250000	0,494 TL	2000
WM 0/12 1.0-2.0 MM WS	Beyaz - 0.5 - 0.75 mm ²	RIBBON MM 80/360 SW	2006170000	0,494 TL	2000
WM 0/21 1.0-2.0 MM GE	Sarı - 0.5 - 0.75 mm ²	RIBBON MM 80/360 SW	2006090000	0,540 TL	2000
WM 0/21 1.0-2.0 MM WS	Beyaz - 0.5 - 0.75 mm ²	RIBBON MM 80/360 SW	2006010000	0,540 TL	2000
WM 0/6 1.0-2.0 MM GE	Sarı - 0.5 - 0.75 mm ²	RIBBON MM 80/360 SW	2006410000	0,475 TL	2000
WM 0/6 1.0-2.0 MM WS	Beyaz - 0.5 - 0.75 mm ²	RIBBON MM 80/360 SW	2006330000	0,475 TL	2000
WM 1/12 2.0-3.5 MM GE	Sarı - 0.75 - 2.5 mm ²	RIBBON MM 80/360 SW	2006270000	0,540 TL	2000
WM 1/12 2.0-3.5 MM WS	Beyaz - 0.75 - 2.5 mm ²	RIBBON MM 80/360 SW	2006190000	0,540 TL	2000
WM 1/21 2.0-3.5 MM GE	Sarı - 0.75 - 2.5 mm ²	RIBBON MM 80/360 SW	2006110000	0,559 TL	2000
WM 1/21 2.0-3.5 MM WS	Beyaz - 0.75 - 2.5 mm ²	RIBBON MM 80/360 SW	2006030000	0,559 TL	2000
WM 1/6 2.0-3.5 MM GE	Sarı - 0.75 - 2.5 mm ²	RIBBON MM 80/360 SW	2006430000	0,494 TL	2000
WM 1/6 2.0-3.5 MM WS	Beyaz - 0.75 - 2.5 mm ²	RIBBON MM 80/360 SW	2006350000	0,494 TL	2000
WM 2/12 3.5-5.0 MM GE	Sarı - 2.5 - 4.0 mm ²	RIBBON MM 80/360 SW	2006290000	0,606 TL	2000
WM 2/12 3.5-5.0 MM WS	Beyaz - 2.5 - 4.0 mm ²	RIBBON MM 80/360 SW	2006210000	0,606 TL	2000
WM 2/21 3.5-5.0 MM GE	Sarı - 2.5 - 4.0 mm ²	RIBBON MM 80/360 SW	2006130000	0,671 TL	2000
WM 2/21 3.5-5.0 MM WS	Beyaz - 2.5 - 4.0 mm ²	RIBBON MM 80/360 SW	2006050000	0,671 TL	2000
WM 2/6 3.5-5.0 MM GE	Sarı - 2.5 - 4.0 mm ²	RIBBON MM 80/360 SW	2006450000	0,559 TL	2000
WM 2/6 3.5-5.0 MM WS	Beyaz - 2.5 - 4.0 mm ²	RIBBON MM 80/360 SW	2006370000	0,559 TL	2000
WM 3/12 5.0-8.0 MM GE	Sarı - 4.0 - 16 mm ²	RIBBON MM 80/360 SW	2006310000	0,755 TL	2000
WM 3/12 5.0-8.0 MM WS	Beyaz - 4.0 - 16 mm ²	RIBBON MM 80/360 SW	2006230000	0,755 TL	2000
WM 3/21 5.0-8.0 MM GE	Sarı - 4.0 - 16 mm ²	RIBBON MM 80/360 SW	2006150000	0,819 TL	2000
WM 3/21 5.0-8.0 MM WS	Beyaz - 4.0 - 16 mm ²	RIBBON MM 80/360 SW	2006070000	0,819 TL	2000
WM 3/6 5.0-8.0 MM GE	Sarı - 4.0 - 16 mm ²	RIBBON MM 80/360 SW	2006470000	0,680 TL	2000
WM 3/6 5.0-8.0 MM WS	Beyaz - 4.0 - 16 mm ²	RIBBON MM 80/360 SW	2006390000	0,680 TL	2000



TM-I 12 MM BL



TM-I 20 MM GE



WM 0/12 1.0-2.0 MM GE



WM 2/12 3.5-5.0 MM WS



SFX 9/24 MM GE



ELS 6/30 MM GE



ESG 6/17 MM GE



ESG 6/17 MM SW



ESG 8/20 MM GR



SM 27/12.5 MM GN

Tip	Renk	Birlikte Kullanılacak Ribon	Sipariş No	Fiyat/Birim	Ambalaj
Kablo Markalama SFX					
SFX 9/24 MM GE	Sarı	RIBBON MM 80/360 SW	2005380000	1,89 TL	1000
SFX 9/24 MM WS	Beyaz	RIBBON MM 80/360 SW	2005320000	1,89 TL	1000
SFX 11/60 MM GE	Sarı	RIBBON MM 80/360 SW	2005400000	2,50 TL	1000
SFX 11/60 MM WS	Beyaz	RIBBON MM 80/360 SW	2005340000	2,50 TL	1000
SFX 30/60 MM GE	Sarı	RIBBON MM 80/360 SW	2005420000	4,00 TL	300
SFX 30/60 MM WS	Beyaz	RIBBON MM 80/360 SW	2005360000	4,00 TL	300
Kablo Markalama ELS Taşıyıcı Kılıf İçi Markalama Yüzeyleri					
ELS 6/30 MM GE	Sarı	RIBBON MM 80/360 SW	2010620000	1,02 TL	3000
ELS 6/30 MM WS	Beyaz	RIBBON MM 80/360 SW	2009980000	1,02 TL	3000
ELS 8/20 MM GE	Sarı	RIBBON MM 80/360 SW	2005240000	0,876 TL	3000
ELS 8/20 MM WS	Beyaz	RIBBON MM 80/360 SW	2005180000	0,876 TL	3000
ELS 16/40 MM GE	Sarı	RIBBON MM 80/360 SW	2005260000	1,35 TL	2000
ELS 16/40 MM WS	Beyaz	RIBBON MM 80/360 SW	2005200000	1,35 TL	2000
Cihaz Markalama ESG, SM					
ESG 6/17 MM GE	Sarı	RIBBON MM 80/360 SW	2005110000	0,867 TL	3000
ESG 6/17 MM GR	Gri	RIBBON MM 80/360 SW	2005120000	0,867 TL	3000
ESG 6/17 MM SW	Siyah	RIBBON MM 80/300 WS	2005130000	0,867 TL	3000
ESG 6/17 MM WS	Beyaz	RIBBON MM 80/360 SW	2005100000	0,867 TL	3000
ESG 8/20 MM GE	Sarı	RIBBON MM 80/360 SW	2005150000	0,913 TL	3000
ESG 8/20 MM GR	Gri	RIBBON MM 80/360 SW	2005160000	0,913 TL	3000
ESG 8/20 MM SW	Siyah	RIBBON MM 80/300 WS	2005170000	0,913 TL	3000
ESG 8/20 MM WS	Beyaz	RIBBON MM 80/360 SW	2005140000	0,913 TL	3000
ESG 9/17 MM GE	Sarı	RIBBON MM 80/360 SW	2005210000	1,15 TL	3000
ESG 9/17 MM GR	Gri	RIBBON MM 80/360 SW	2005230000	1,15 TL	3000
ESG 9/17 MM SW	Siyah	RIBBON MM 80/300 WS	2005250000	1,15 TL	3000
ESG 9/17 MM WS	Beyaz	RIBBON MM 80/360 SW	2005190000	1,15 TL	3000
SM 18/9.5 MM GE	Sarı	RIBBON MM 80/360 SW	2006240000	2,70 TL	1000
SM 18/9.5 MM GR	Gri	RIBBON MM 80/360 SW	2006260000	2,70 TL	1000
SM 18/9.5 MM SW	Siyah	RIBBON MM 80/300 WS	2006200000	2,70 TL	1000
SM 18/9.5 MM WS	Beyaz	RIBBON MM 80/360 SW	2006220000	2,70 TL	1000
SM 27/8 MM GE	Sarı	RIBBON MM 80/360 SW	2006420000	2,00 TL	1000
SM 27/8 MM GN	Yeşil	RIBBON MM 80/360 SW	2006490000	2,00 TL	1000
SM 27/8 MM GR	Gri	RIBBON MM 80/360 SW	2006480000	2,00 TL	1000
SM 27/8 MM RT	Kırmızı	RIBBON MM 80/360 SW	2006460000	2,00 TL	1000
SM 27/8 MM SW	Siyah	RIBBON MM 80/300 WS	2006440000	2,00 TL	1000
SM 27/8 MM WS	Beyaz	RIBBON MM 80/360 SW	2006400000	2,00 TL	1000
SM 27/12.5 MM GE	Sarı	RIBBON MM 80/360 SW	2006510000	2,45 TL	1000
SM 27/12.5 MM GN	Yeşil	RIBBON MM 80/360 SW	2006550000	2,45 TL	1000
SM 27/12.5 MM GR	Gri	RIBBON MM 80/360 SW	2006520000	2,45 TL	1000
SM 27/12.5 MM RT	Kırmızı	RIBBON MM 80/360 SW	2006540000	2,45 TL	1000
SM 27/12.5 MM SW	Siyah	RIBBON MM 80/300 WS	2006530000	2,45 TL	1000
SM 27/12.5 MM WS	Beyaz	RIBBON MM 80/360 SW	2006500000	2,45 TL	1000
SM 27/18 MM GE	Sarı	RIBBON MM 80/360 SW	2006300000	3,10 TL	1000
SM 27/18 MM GN	Yeşil	RIBBON MM 80/360 SW	2006380000	3,10 TL	1000
SM 27/18 MM GR	Gri	RIBBON MM 80/360 SW	2006340000	3,10 TL	1000
SM 27/18 MM RT	Kırmızı	RIBBON MM 80/360 SW	2006360000	3,10 TL	1000
SM 27/18 MM SW	Siyah	RIBBON MM 80/300 WS	2006320000	3,10 TL	1000
SM 27/18 MM WS	Beyaz	RIBBON MM 80/360 SW	2006280000	3,10 TL	1000
SM 27/18-22 MM GE	Sarı	RIBBON MM 80/360 SW	2005810000	4,85 TL	1000
SM 27/18-22 MM GN	Yeşil	RIBBON MM 80/360 SW	2005920000	4,85 TL	1000

Serinin devamı sayfa 47

Tip	Renk	Birlikte Kullanılacak Ribon	Sipariş No	Fiyat/Birim	Ambalaj
SM 27/18-22 MM GR	Gri	RIBBON MM 80/360 SW	2005860000	4,85 TL	1000
SM 27/18-22 MM RT	Kırmızı	RIBBON MM 80/360 SW	2005900000	4,85 TL	1000
SM 27/18-22 MM SW	Siyah	RIBBON MM 80/300 WS	2005880000	4,85 TL	1000
SM 27/18-22 MM WS	Beyaz	RIBBON MM 80/360 SW	2005840000	4,85 TL	1000
SM 36/18-30 MM GE	Sarı	RIBBON MM 80/360 SW	2006080000	5,35 TL	1000
SM 36/18-30 MM GN	Yeşil	RIBBON MM 80/360 SW	2006180000	5,35 TL	1000
Cihaz Markalama SM, CC, EL					
SM 36/18-30 MM GR	Gri	RIBBON MM 80/360 SW	2006120000	5,35 TL	1000
SM 36/18-30 MM RT	Kırmızı	RIBBON MM 80/360 SW	2006160000	5,35 TL	1000
SM 36/18-30 MM SW	Siyah	RIBBON MM 80/300 WS	2006140000	5,35 TL	1000
SM 36/18-30 MM WS	Beyaz	RIBBON MM 80/360 SW	2006100000	5,35 TL	1000
SM DIA 60-22 MM GE	Sarı	RIBBON MM 80/360 SW	2006060000	6,95 TL	450
CC 15/27 MM GE	Sarı	RIBBON MM 80/360 SW	2005630000	1,12 TL	450
CC 15/27 MM GR	Gri	RIBBON MM 80/360 SW	2005660000	1,12 TL	450
CC 15/27 MM SW	Siyah	RIBBON MM 80/300 WS	2005690000	1,12 TL	450
CC 15/27 MM WS	Beyaz	RIBBON MM 80/360 SW	2005600000	1,12 TL	450
CC 15/45 MM GE	Sarı	RIBBON MM 80/360 SW	2005520000	1,69 TL	450
CC 15/45 MM GR	Gri	RIBBON MM 80/360 SW	2005540000	1,69 TL	450
CC 15/45 MM SW	Siyah	RIBBON MM 80/300 WS	2005570000	1,69 TL	450
CC 15/45 MM WS	Beyaz	RIBBON MM 80/360 SW	2005500000	1,69 TL	450
CC 15/60 MM GE	Sarı	RIBBON MM 80/360 SW	2005430000	2,10 TL	450
CC 15/60 MM GR	Gri	RIBBON MM 80/360 SW	2005460000	2,10 TL	450
CC 15/60 MM SW	Siyah	RIBBON MM 80/300 WS	2005480000	2,10 TL	450
CC 15/60 MM WS	Beyaz	RIBBON MM 80/360 SW	2005410000	2,10 TL	450
CC 30/60 MM GE	Sarı	RIBBON MM 80/360 SW	2005350000	4,30 TL	450
CC 30/60 MM GR	Gri	RIBBON MM 80/360 SW	2005370000	4,30 TL	450
CC 30/60 MM SW	Siyah	RIBBON MM 80/300 WS	2005390000	4,30 TL	450
CC 30/60 MM WS	Beyaz	RIBBON MM 80/360 SW	2005330000	4,30 TL	450
CC 85/54 MM GE	Sarı	RIBBON MM 80/360 SW	2005280000	10,95 TL	450
CC 85/54 MM GR	Gri	RIBBON MM 80/360 SW	2005290000	10,95 TL	450
CC 85/54 MM SW	Siyah	RIBBON MM 80/300 WS	2005310000	10,95 TL	450
CC 85/54 MM WS	Beyaz	RIBBON MM 80/360 SW	2005270000	10,95 TL	450
EL 12 MM GE 30M	Sarı	RIBBON MM 80/360 SW	2006580000	344,65 TL	1
EL 12 MM WS 30M	Beyaz	RIBBON MM 80/360 SW	2006570000	344,65 TL	1
EL 15 MM GE 30M	Sarı	RIBBON MM 80/360 SW	2006600000	428,50 TL	1
EL 15 MM SI 30M	Gümüş	RIBBON MM 80/360 SW	2006610000	428,50 TL	1
EL 15 MM WS 30M	Beyaz	RIBBON MM 80/360 SW	2006590000	428,50 TL	1
EL 27 MM GE 30M	Sarı	RIBBON MM 80/360 SW	2006640000	774,00 TL	1
EL 27 MM SI 30M	Gümüş	RIBBON MM 80/360 SW	2006620000	774,00 TL	1
EL 27 MM WS 30M	Beyaz	RIBBON MM 80/360 SW	2006630000	774,00 TL	1
EL 38 MM GE 30M	Sarı	RIBBON MM 80/360 SW	2006670000	1.088,00 TL	1
EL 38 MM SI 30M	Gümüş	RIBBON MM 80/360 SW	2006650000	1.088,00 TL	1
EL 38 MM WS 30M	Beyaz	RIBBON MM 80/360 SW	2006660000	1.088,00 TL	1
EL 60 MM GE 30M	Sarı	RIBBON MM 80/360 SW	2006700000	1.710,00 TL	1
EL 60 MM SI 30M	Gümüş	RIBBON MM 80/360 SW	2006680000	1.710,00 TL	1
EL 60 MM WS 30M	Beyaz	RIBBON MM 80/360 SW	2006690000	1.710,00 TL	1
EL 100 MM GE 30M	Sarı	RIBBON MM 110/360 SW	2006730000	2.851,00 TL	1
EL 100 MM SI 30M	Gümüş	RIBBON MM 110/360 SW	2006710000	2.851,00 TL	1
EL 100 MM WS 30M	Beyaz	RIBBON MM 110/360 SW	2006720000	2.851,00 TL	1

Not: Markalamalar ile kullanılacak ribonlar "Cihaz Aksesuarları" başlığı altından haricen sipariş edilmelidir



SM 36/18-30 MM GR



CC 15/27 MM WS



EL 12 MM GE 30M



WKM 18/43



HSS-HF 1.2-2.4 EL Y13M



HSS-HF 12.7-25.4 EL W10M



LM MT300 15/6 WS

Tip	Açıklama	En / Boy	Sipariş No	Fiyat/Birim	Ambalaj
Kablo Markalama Yüzeyleri					
WKM 18/43	Kablo markalama	18 / 43 mm	1610700000	7,85 TL	50
WKM 8/20	Kablo markalama	8 / 20 mm	1753490000	7,45 TL	50
WKM 8/30	Kablo markalama	8 / 30 mm	1631910000	7,45 TL	50

Tip	Açıklama	Ölçü / Renk	Sipariş No	Fiyat/Birim	Ambalaj
Kablo Markalama Yüzeyleri					
ESO 5 DIN A4 WS	Beyaz, Tabaka/60	40 x 16,5 mm / Beyaz	1607710000	21,00 TL	10
ESO 7 DIN A4 WS	Beyaz, Tabaka/60	27 x 6,3 mm /Beyaz	1607720000	21,00 TL	10

Tip	Kesit	Ölçü	Sipariş No	Fiyat/Birim	Ambalaj
HSS Daralan Makoron - Şerit Tipi					
HSS-HF 1.2-2.4 EL Y13M	0.25 - 0.5 mm ² kablo çapı	13 Metre	1423220000	387,50 TL	1
HSS-HF 1.6-3.2 EL Y13M	0.5 - 0.15 mm ² kablo çapı	13 Metre	1423230000	411,75 TL	1
HSS-HF 2.4-4.8 EL Y13M	0.75 - 4 mm ² kablo çapı	13 Metre	1423240000	480,65 TL	1
HSS-HF 3.2-6.4 EL Y13M	1.5 - 6 mm ² kablo çapı	13 Metre	1423250000	579,00 TL	1
HSS-HF 4.8-9.5 EL Y13M	4.00 - 16 mm ² kablo çapı	13 Metre	1423260000	794,00 TL	1
HSS-HF 6.4-12.7 EL Y13M	6 - 35 mm ² kablo çapı	13 Metre	1423270000	914,00 TL	1
HSS-HF 9.5-19.1 EL Y10M	16 - 70 mm ² kablo çapı	10 Metre	1423280000	1.002,00 TL	1
HSS-HF 12.7-25.4 EL Y10M	35 - 120 mm ² kablo çapı	10 Metre	1423290000	1.416,00 TL	1
HSS-HF 1.2-2.4 EL W13M	0.25 - 0.5 mm ² kablo çapı	13 Metre	1423330000	385,65 TL	1
HSS-HF 1.6-3.2 EL W13M	0.5 - 0.15 mm ² kablo çapı	13 Metre	1423340000	411,75 TL	1
HSS-HF 2.4-4.8 EL W13M	0.75 - 4 mm ² kablo çapı	13 Metre	1423350000	480,65 TL	1
HSS-HF 3.2-6.4 EL W13M	1.5 - 6 mm ² kablo çapı	13 Metre	1423360000	579,00 TL	1
HSS-HF 4.8-9.5 EL W13M	4.00 - 16 mm ² kablo çapı	13 Metre	1423370000	794,00 TL	1
HSS-HF 6.4-12.7 EL W13M	6 - 35 mm ² kablo çapı	13 Metre	1423380000	914,00 TL	1
HSS-HF 9.5-19.1 EL W10M	16 - 70 mm ² kablo çapı	13 Metre	1423390000	1.002,00 TL	1
HSS-HF 12.7-25.4 EL W10M	35 - 120 mm ² kablo çapı	10 Metre	1423410000	1.416,00 TL	1
HSS-HF 1.2-2.4 EL Y30M	0.25 - 0.5 mm ² kablo çapı	10 Metre	1513140000	833,00 TL	1
HSS-HF 1.6-3.2 EL Y30M	0.5 - 0.15 mm ² kablo çapı	30 Metre	1513150000	884,00 TL	1
HSS-HF 2.4-4.8 EL Y30M	0.75 - 4 mm ² kablo çapı	30 Metre	1513170000	1.027,00 TL	1
HSS-HF 3.2-6.4 EL Y30M	1.5 - 6 mm ² kablo çapı	30 Metre	1513180000	1.247,00 TL	1
HSS-HF 4.8-9.5 EL Y30M	4.00 - 16 mm ² kablo çapı	30 Metre	1513190000	1.704,00 TL	1
HSS-HF 6.4-12.7 EL Y30M	6 - 35 mm ² kablo çapı	30 Metre	1513200000	1.958,00 TL	1
HSS-HF 9.5-19.1 EL Y30M	16 - 70 mm ² kablo çapı	30 Metre	1513220000	2.786,00 TL	1
HSS-HF 12.7-25.4 EL Y30M	35 - 120 mm ² kablo çapı	30 Metre	1513230000	3.946,00 TL	1
HSS-HF 1.2-2.4 EL W30M	0.25 - 0.5 mm ² kablo çapı	30 Metre	1513240000	833,00 TL	1
HSS-HF 1.6-3.2 EL W30M	0.5 - 0.15 mm ² kablo çapı	30 Metre	1513250000	884,00 TL	1
HSS-HF 2.4-4.8 EL W30M	0.75 - 4 mm ² kablo çapı	30 Metre	1513270000	1.027,00 TL	1
HSS-HF 3.2-6.4 EL W30M	1.5 - 6 mm ² kablo çapı	30 Metre	1513280000	1.247,00 TL	1
HSS-HF 4.8-9.5 EL W30M	4.00 - 16 mm ² kablo çapı	30 Metre	1513290000	1.704,00 TL	1
HSS-HF 6.4-12.7 EL W30M	6 - 35 mm ² kablo çapı	30 Metre	1513300000	1.958,00 TL	1
HSS-HF 9.5-19.1 EL W30M	16 - 70 mm ² kablo çapı	30 Metre	1513320000	2.786,00 TL	1
HSS-HF 12.7-25.4 EL W30M	35 - 120 mm ² kablo çapı	30 Metre	1513330000	3.946,00 TL	1

Not: 30m'lik Isıyla Daralan Makaronlar İçin Taşıyıcı Aparat Kullanılması Önerilir.

Tip	Renk	Ölçü / Adet	Sipariş No	Fiyat/Birim	Ambalaj
Cihaz Etiketleri					
LM MT300 15/6 WS	Beyaz	15,2x6 mm / 484 Adet	1686361044	98,75 TL	10
LM MT300 15/6 GE	Sarı	15,2x6 mm / 484 Adet	1686361687	98,75 TL	10
LM MT300 15/6 SI	Gümüş	15,2x6 mm / 484 Adet	1686360001	98,75 TL	10
LM MT300 17/9 WS	Beyaz	17,8x9 mm / 341 Adet	1724151044	98,75 TL	10
LM MT300 17/9 GE	Sarı	17,8x9 mm / 341 Adet	1724151687	98,75 TL	10

Serinin devamı sayfa 49

Tip	Renk	Ölçü / Adet	Sipariş No	Fiyat/Birim	Ambalaj
LM MT300 17/9 SI	Gümüş	17,8x9 mm / 341 Adet	1724150001	98,75 TL	10
LM MT300 20/8 WS	Beyaz	20,3x8 mm / 264 Adet	1686381044	98,75 TL	10
LM MT300 20/8 GE	Sarı	20,3x8 mm / 264 Adet	1686381687	98,75 TL	10
LM MT300 20/8 SI	Gümüş	20,3x8 mm / 264 Adet	1686380001	98,75 TL	10
LM MT300 26/10 WS	Beyaz	26,0x10 mm / 156 Adet	1686401044	98,75 TL	10
LM MT300 26/10 GE	Sarı	26,0x10 mm / 156 Adet	1686401687	98,75 TL	10
LM MT300 26/10 SI	Gümüş	26,0x10 mm / 156 Adet	1686400001	98,75 TL	10
LM MT300 56/22 WS	Beyaz	56,0x22 mm / 36 Adet	1686421044	98,75 TL	10
LM MT300 56/22 GE	Sarı	56,0x22 mm / 36 Adet	1686421687	98,75 TL	10
LM MT300 56/22 SI	Gümüş	56,0x22 mm / 36 Adet	1686420001	98,75 TL	10

Tip	Renk	Tabaka/Adet	Sipariş No	Fiyat/Birim	Ambalaj
Cihaz Etiketleri (Tekstil Tip Örme Yüzeyler)					
TABPACK 14X9	Sarı	Sayfa başına 840 adet	1686110000	276,70 TL	1
TABPACK 15X6	Sarı	Sayfa başına 1000 adet	1686120000	279,45 TL	1
TABPACK 19X11 M. RAND	Sarı	Sayfa başına 440 adet	1686130000	279,45 TL	1
TABPACK 21X8	Sarı	Sayfa başına 640 adet	1686140000	279,45 TL	1
TABPACK 38X11 M. RAND	Sarı	Sayfa başı 22 adet	1686150000	277,55 TL	1
PAGETAB 15/9	Sarı A4 Formatı	Sayfa başı 310 adet	1686160000	84,80 TL	25
PAGETAB 19/11	Sarı A4 Formatı	Sayfa başı 200 adet	1686170000	84,80 TL	25
PAGETAB 20/8	Sarı A4 Formatı	Sayfa başı 280 adet	1686180000	85,70 TL	25
PAGETAB 28/11	Sarı A4 Formatı	Sayfa başı 125 adet	1686190000	85,70 TL	25
PAGETAB 38/11	Sarı A4 Formatı	Sayfa başı 100 adet	1686200000	85,70 TL	25
PAGETAB 56/22	Sarı A4 Formatı	Sayfa başı 24 adet	1686210000	83,85 TL	25

Tip	Çap	Ölçü / Renk / Adet	Sipariş No	Fiyat/Birim	Ambalaj
WriteOn - Kablo ve İletken Markalaması					
LM WO 15/70 WS	8,2 - 14,3 mm	15 x 30 mm / Beyaz / 30 Adet	1759871044	162,70 TL	10
LM WO 15/140 WS	16,2 - 36,4 mm	15 x 70 mm / Beyaz / 26 Adet	1773880000	127,65 TL	10
LM WO 18/34 WS	5,0 - 7,0 mm	18 x 12,7 mm / Beyaz / 88 Adet	1695711044	118,35 TL	10
LM WO 18/34 GE	5,0 - 7,0 mm	18 x 12,7 mm / Sarı / 88 Adet	1695711687	118,35 TL	10
LM WO 23/55 WS	6,8 - 12,0 mm	23 x 12,7 mm / Beyaz / 40 Adet	1695721044	149,20 TL	10
LM WO 23/55 GE	6,8 - 12,0 mm	23 x 12,7 mm / Sarı / 40 Adet	1695721687	149,20 TL	10
LM WO 25/68 WS	8,2 - 14,3 mm	25 x 17 mm / Beyaz / 28 Adet	1695731044	118,35 TL	10
LM WO 25/68 GE	8,2 - 14,3 mm	25 x 17 mm / Sarı / 28 Adet	1695731687	118,35 TL	10
LM WO 25/140 WS	16,2 x 36,4 mm	25 x 26 mm / Beyaz / 16 Adet	1712491044	118,35 TL	10
LM WO 25/140 GE	16,2 x 36,4 mm	25 x 26 mm / Sarı / 16 Adet	1712491687	118,35 TL	10
LM WO 36/93 WS	9,5 - 22,3 mm	36 x 25 mm / Beyaz / 15 Adet	1695741044	149,20 TL	10
LM WO 36/93 GE	9,5 - 22,3 mm	36 x 25 mm / Sarı / 15 Adet	1695741687	149,20 TL	10



TABPACK 14X9



LM WO 15/70 WS

PCB - Baskılı Devre Klemensleri



SL 3.50/02/90 3.2SN OR BX



SL 3.50/02/180 3.2SN OR BX



BL 3.50/02/180 SN OR BX



BLZP 5.08HC/02/180 SN OR BX

Tip	V / A	Açıklama	Sipariş No	Fiyat/Birim	Ambalaj
OMNIMATE Baskılı Devre Fiş/Soket Konnektörleri: SL/BL Sistemi. Pin Aralığı: 3,50 mm					
Yatay Fiş					
SL 3.50/02/90 3.2SN OR BX	250 / 17	2 Kutup	1597210000	3,10 TL	100
SL 3.50/03/90 3.2SN OR BX	250 / 17	3 Kutup	1597220000	4,95 TL	100
SL 3.50/04/90 3.2SN OR BX	250 / 17	4 Kutup	1597230000	6,20 TL	100
SL 3.50/05/90 3.2SN OR BX	250 / 17	5Kutup	1597240000	8,10 TL	50
SL 3.50/06/90 3.2SN OR BX	250 / 17	6 Kutup	1597250000	9,70 TL	50
SL 3.50/07/90 3.2SN OR BX	250 / 17	7 Kutup	1597260000	11,00 TL	50
SL 3.50/08/90 3.2SN OR BX	250 / 17	8 Kutup	1597270000	12,90 TL	50
SL 3.50/09/90 3.2SN OR BX	250 / 17	9 Kutup	1597280000	14,30 TL	50
SL 3.50/10/90 3.2SN OR BX	250 / 17	10 Kutup	1597290000	16,25 TL	50
SL 3.50/11/90 3.2SN OR BX	250 / 17	11 Kutup	1597300000	17,70 TL	50
SL 3.50/12/90 3.2SN OR BX	250 / 17	12 Kutup	1597310000	19,10 TL	50
Dikey Fiş					
SL 3.50/02/180 3.2SN OR BX	250 / 17	2 Kutup	1604770000	3,10 TL	100
SL 3.50/03/180 3.2SN OR BX	250 / 17	3 Kutup	1604780000	4,95 TL	100
SL 3.50/04/180 3.2SN OR BX	250 / 17	4 Kutup	1604790000	6,20 TL	100
SL 3.50/05/180 3.2SN OR BX	250 / 17	5Kutup	1604800000	8,10 TL	50
SL 3.50/06/180 3.2SN OR BX	250 / 17	6 Kutup	1604810000	9,70 TL	50
SL 3.50/07/180 3.2SN OR BX	250 / 17	7 Kutup	1604820000	11,00 TL	50
SL 3.50/08/180 3.2SN OR BX	250 / 17	8 Kutup	1604830000	12,90 TL	50
SL 3.50/09/180 3.2SN OR BX	250 / 17	9 Kutup	1604840000	14,30 TL	50
SL 3.50/10/180 3.2SN OR BX	250 / 17	10 Kutup	1604850000	16,25 TL	50
SL 3.50/11/180 3.2SN OR BX	250 / 17	11 Kutup	1604860000	17,70 TL	50
SL 3.50/12/180 3.2SN OR BX	250 / 17	12 Kutup	1604870000	19,10 TL	50
Soket					
BL 3.50/02/180 SN OR BX	250 / 12	2 Kutup	1597360000	8,45 TL	264
BL 3.50/03/180 SN OR BX	250 / 12	3 Kutup	1597370000	12,90 TL	174
BL 3.50/04/180 SN OR BX	250 / 12	4 Kutup	1597380000	16,65 TL	132
BL 3.50/05/180 SN OR BX	250 / 12	5Kutup	1597390000	21,55 TL	102
BL 3.50/06/180 SN OR BX	250 / 12	6 Kutup	1597400000	25,85 TL	84
BL 3.50/07/180 SN OR BX	250 / 12	7 Kutup	1597410000	30,10 TL	72
BL 3.50/08/180 SN OR BX	250 / 12	8 Kutup	1597420000	33,95 TL	66
BL 3.50/09/180 SN OR BX	250 / 12	9 Kutup	1597430000	38,20 TL	54
BL 3.50/10/180 SN OR BX	250 / 12	10 Kutup	1597440000	42,50 TL	48
BL 3.50/11/180 SN OR BX	250 / 12	11 Kutup	1597450000	47,30 TL	48
BL 3.50/12/180 SN OR BX	250 / 12	12 Kutup	1597460000	51,55 TL	42
OMNIMATE Baskılı Devre Fiş/Soket Konnektörleri: SL/BL Sistemi. Pin Aralığı: 5,08 mm					
Yatay Soket (Vidalı Bağlantı)					
BLZP 5.08HC/02/180 SN OR BX	400 / 19	2 Kutup	1943580000	7,65 TL	180
BLZP 5.08HC/03/180 SN OR BX	400 / 19	3 Kutup	1943590000	11,45 TL	120
BLZP 5.08HC/04/180 SN OR BX	400 / 19	4 Kutup	1943600000	15,30 TL	90
BLZP 5.08HC/05/180 SN OR BX	400 / 19	5Kutup	1943610000	19,10 TL	72
BLZP 5.08HC/06/180 SN OR BX	400 / 19	6 Kutup	1943620000	22,95 TL	60
BLZP 5.08HC/07/180 SN OR BX	400 / 19	7 Kutup	1943630000	29,15 TL	48
BLZP 5.08HC/08/180 SN OR BX	400 / 19	8 Kutup	1943640000	30,65 TL	42
BLZP 5.08HC/09/180 SN OR BX	400 / 19	9 Kutup	1943650000	37,25 TL	36
BLZP 5.08HC/10/180 SN OR BX	400 / 19	10 Kutup	1943660000	41,05 TL	36
BLZP 5.08HC/11/180 SN OR BX	400 / 19	11 Kutup	1943670000	45,35 TL	30
BLZP 5.08HC/12/180 SN OR BX	400 / 19	12 Kutup	1943680000	49,75 TL	30



BLF 5.08HC/02/180 SN OR BX



SLA 02/90 3.2SN OR BX



SLA 02/180 3.2SN OR BX



SLAD 04/90 3.2SN OR



BLA 2 SN OR

Tip	V / A	Açıklama	Sipariş No	Fiyat/Birim	Ambalaj
Yatay Soket (Yaylı Bağlantı)					
BLF 5.08HC/02/180 SN OR BX	400 / 24	2 Kutup	1013680000	7,45 TL	180
BLF 5.08HC/03/180 SN OR BX	400 / 24	3 Kutup	1013690000	11,25 TL	120
BLF 5.08HC/04/180 SN OR BX	400 / 24	4 Kutup	1013710000	14,85 TL	90
BLF 5.08HC/05/180 SN OR BX	400 / 24	5Kutup	1013720000	18,65 TL	72
BLF 5.08HC/06/180 SN OR BX	400 / 24	6 Kutup	1013730000	22,40 TL	60
BLF 5.08HC/07/180 SN OR BX	400 / 24	7 Kutup	1013740000	26,35 TL	48
BLF 5.08HC/08/180 SN OR BX	400 / 24	8 Kutup	1013750000	30,10 TL	42
BLF 5.08HC/09/180 SN OR BX	400 / 24	9 Kutup	1013760000	33,95 TL	36
BLF 5.08HC/10/180 SN OR BX	400 / 24	10 Kutup	1013770000	37,25 TL	36
BLF 5.08HC/11/180 SN OR BX	400 / 24	11 Kutup	1013780000	41,05 TL	30
BLF 5.08HC/12/180 SN OR BX	400 / 24	12 Kutup	1013790000	44,95 TL	30
Yatay Fiş					
SLA 02/90 3.2SN OR BX	400 / 17,5	2 Kutup	1238060000	3,50 TL	100
SLA 03/90 3.2SN OR BX	400 / 17,5	3 Kutup	1238160000	5,40 TL	100
SLA 04/90 3.2SN OR BX	400 / 17,5	4 Kutup	1238260000	5,35 TL	100
SLA 05/90 3.2SN OR BX	400 / 17,5	5Kutup	1238360000	6,75 TL	50
SLA 06/90 3.2SN OR BX	400 / 17,5	6 Kutup	1238460000	9,50 TL	50
SLA 07/90 3.2SN OR BX	400 / 17,5	7 Kutup	1238560000	11,00 TL	50
SLA 08/90 3.2SN OR BX	400 / 17,5	8 Kutup	1238660000	10,55 TL	50
SLA 09/90 3.2SN OR BX	400 / 17,5	9 Kutup	1238760000	12,00 TL	50
SLA 10/90 3.2SN OR BX	400 / 17,5	10 Kutup	1238860000	16,00 TL	50
SLA 11/90 3.2SN OR BX	400 / 17,5	11 Kutup	1238960000	14,85 TL	50
SLA 12/90 3.2SN OR BX	400 / 17,5	12 Kutup	1239060000	16,25 TL	50
Dikey Fiş					
SLA 02/180 3.2SN OR BX	400 / 17,5	2 Kutup	1239560000	2,70 TL	100
SLA 03/180 3.2SN OR BX	400 / 17,5	3 Kutup	1239660000	4,10 TL	100
SLA 04/180 3.2SN OR BX	400 / 17,5	4 Kutup	1239760000	6,60 TL	100
SLA 05/180 3.2SN OR BX	400 / 17,5	5Kutup	1239860000	8,50 TL	50
SLA 06/180 3.2SN OR BX	400 / 17,5	6 Kutup	1239960000	9,50 TL	50
SLA 07/180 3.2SN OR BX	400 / 17,5	7 Kutup	1240060000	11,00 TL	50
SLA 08/180 3.2SN OR BX	400 / 17,5	8 Kutup	1240160000	10,55 TL	50
SLA 09/180 3.2SN OR BX	400 / 17,5	9 Kutup	1240260000	12,00 TL	50
SLA 10/180 3.2SN OR BX	400 / 17,5	10 Kutup	1240360000	13,35 TL	50
SLA 11/180 3.2SN OR BX	400 / 17,5	11 Kutup	1240460000	14,85 TL	50
SLA 12/180 3.2SN OR BX	400 / 17,5	12 Kutup	1240560000	16,25 TL	50
Yatay Fiş - İki Katlı					
SLAD 04/90 3.2SN OR	400 / 10	4 Kutup	1320060000	9,40 TL	50
SLAD 06/90 3.2SN OR	400 / 10	6 Kutup	1320160000	14,30 TL	50
SLAD 08/90 3.2SN OR	400 / 10	8 Kutup	1372460000	18,65 TL	50
SLAD 12/06/90 3.2SN OR	400 / 10	12 Kutup	1372660000	28,20 TL	50
Soket					
BLA 2 SN OR	400 / 17,5	2 Kutup	1281760000	8,10 TL	180
BLA 3 SN OR	400 / 17,5	3 Kutup	1281860000	12,00 TL	120
BLA 4 SN OR	400 / 17,5	4 Kutup	1281960000	20,00 TL	90
BLA 5 SN OR	400 / 17,5	5Kutup	1282060000	22,00 TL	72
BLA 6 SN OR	400 / 17,5	6 Kutup	1282160000	30,00 TL	60
BLA 7 SN OR	400 / 17,5	7 Kutup	1282260000	35,00 TL	48
BLA 8 SN OR	400 / 17,5	8 Kutup	1282360000	37,00 TL	42
BLA 9 SN OR	400 / 17,5	9 Kutup	1282460000	40,00 TL	36
BLA 10 SN OR	400 / 17,5	10 Kutup	1282560000	50,00 TL	36

Serinin devamı sayfa 52

PCB - Baskılı Devre Klemensleri



PS 3.50/02/90 3.5SN BK BX



LS 5.08/02/90 3.5SN BK BX



LPP 5.08/02/90 3.2SN OR BX



LSF-SMT 5.08/02/180 3.5SN BK TU

Tip	V / A	Açıklama	Sipariş No	Fiyat/Birim	Ambalaj
BLA 11 SN OR	400 / 17,5	11 Kutup	1282660000	52,00 TL	30
BLA 12 SN OR	400 / 17,5	12 Kutup	1282760000	55,00 TL	30
PS Sistemi. Pin Aralığı: 3,50 mm - Pin Uzunluk 3,50 mm					
PS 3.50/02/90 3.5SN BK BX	320 / 17,5	2 Kutup	1811180000	2,50 TL	100
PS 3.50/03/90 3.5SN BK BX	320 / 17,5	3 Kutup	1811190000	3,60 TL	100
PM Sistemi. Pin Aralığı: 5,08 mm - Pin Uzunluk 3,50 mm					
PM 5.08/02/90 3.5SN OR BX	600 / 24	2 Kutup	1760490000	1,76 TL	500
PM 5.08/03/90 3.5SN OR BX	600 / 24	3 Kutup	1760500000	2,55 TL	500
LS Sistemi. Pin Aralığı: 5,08 mm - Pin Uzunluk 3,50 mm					
LS 5.08/02/90 3.5SN BK BX	600 / 24	2 Kutup	1810850000	3,10 TL	100
LS 5.08/03/90 3.5SN BK BX	600 / 24	3 Kutup	1810860000	4,70 TL	100
LM Sistemi. Pin Aralığı: 5,08 mm - Pin Uzunluk 3,50 mm					
LM 5.08/02/90 3.5SN OR BX	600 / 17,5	2 Kutup	1716080000	3,30 TL	500
LM 5.08/03/90 3.5SN OR BX	600 / 17,5	3 Kutup	1716090000	4,95 TL	500
LP Sistemi. Pin Aralığı: 5,08 mm - Pin Uzunluk 3,20 mm					
LPP 5.08/02/90 3.2SN OR BX	500 / 32	2 Kutup	1594400000	6,20 TL	100
LPP 5.08/03/90 3.2SN OR BX	500 / 32	3 Kutup	1594410000	9,40 TL	100
LSF Sistemi. Pin Aralığı: 5,08 mm - Pin Uzunluk 3,50 mm					
LSF-SMT 5.08/02/90 3.5SN BK TU	500 / 17,5	2 Kutup	1824810000	3,60 TL	59
LSF-SMT 5.08/03/90 3.5SN BK TU	500 / 17,5	3 Kutup	1824820000	5,35 TL	38
LSF Sistemi. Pin Aralığı: 5,08 mm - Pin Uzunluk 3,50 mm (THR Reflow Lehimleme)					
LSF-SMT 5.08/02/180 3.5SN BK TU	500 / 17,5	2 Kutup	1826040000	3,60 TL	59
LSF-SMT 5.08/03/180 3.5SN BK TU	500 / 17,5	3 Kutup	1826060000	5,35 TL	38
SMD Sistemi					
LSF-SMD 3.50/02/180 SN BK RL	500 / 17,5	2 Kutup	1250360000	10,25 TL	235
LSF-SMD 3.50/03/180 SN BK RL	500 / 17,5	3 Kutup	1250370000	12,90 TL	180
Tip	Açıklama	Sipariş No	Fiyat/Birim	Ambalaj	
Baskılı Devre Kartı, Raya Montaj Malzemeleri					
HP SKH	SKH İçin Tutucu Bara	0137100000	2,20 €	20	
SKH SAEULE PBTP20GV OR	Baskılı Devre Kızağı	0550160000	2,60 €	10	
RH 1 F.SKH 31 S	Baskılı Devre Mandalı	0587160000	18,65 TL	20	
RH 2 F.SKH 32-48	Baskılı Devre Mandalı	0632760000	5,55 TL	20	
FM 4/TS35	TS 35 Ray Adaptörü	0687900000	7,65 TL	40	
MB M6/M4 GR	TS 32 Ray Adaptörü	0334900000	8,55 TL	20	
RF RS 70 RE/A4/O.BEZ OR	Sağ Ayak	0126260000	18,65 TL	20	
RF RS 70 LI/A2/O.SG OR	Sol Ayak	0119660000	16,25 TL	20	
RF RS 70 MI/A6 OR	Orta Ayak	0213760000	16,25 TL	20	
ZW 5 RS OR	5 mm'lik Profil	0119760000	16,25 TL	20	
ZW 15 RS OR	15 mm'lik Profil	0119860000	18,65 TL	20	
ZW 25 RS OR	25 mm'lik Profil	0126160000	18,65 TL	20	
ZW 30 RS OR	30 mm'lik Profil	0119960000	19,55 TL	20	
ZW 45 RS OR	45 mm'lik Profil	0120060000	20,60 TL	20	
PF RS 80 OR 2000MM	84 mm'lik Profil (2m)	4157440000	178,75 TL	2	
RF 180 OR	Montaj Ayağı	1324460000	16,25 TL	20	
AP 80 OR	Nihayet Plakası	1324260000	14,30 TL	20	
PF RS 100 OR 2000MM A.1	Profil 104 mm (2m)	4144870000	224,65 TL	2	
AP 100 OR	Nihayet Plakası	1185060000	18,65 TL	20	
Baskılı Devre Kızağı (Komple)					
SKH D32 LP 5/16 RH2	Baskılı Devre Kızağı	0586761001	70,00 €	1	
SKH 31 LP 250VAC RH1	Baskılı Devre Kızağı	0648661001	65,00 €	1	

RockStar® - Sanayi Tipi Fiş - Soketlerde Yeni Boyut

Ağır çevre koşulları altında güvenli ve modüler bağlantı gerektiren, makina ve diğer elektrik bağlantılarında kullanılır. Çok dayanıklı alüminyum dökümden imal edilen kutular rutubet, kirli ortam ve mekanik darbe gibi çevresel koşullarda mükemmel bir koruma sağlar.

Özel modüler klemens kombinasyonları, enerji iletimini pnomatik ve data sinyalleri ile tek bir kutuda birleştirebilir.

Weidmüller patentli kilitleme mekanizması ile RockStar® ağır şartlar için ihtiyaç duyulan çok çeşitli bağlantıları içerir. Ürün yelpazemiz ile çeşitli uygulama ihtiyaçlarınıza tam olarak cevap vererek ürünlerinizin kalitesini üst seviyeye taşır.

Rockstar ihtiyacınıza uygun ürünü bulmanızı kolaylaştırarak zaman ve maliyet avantajı sağlar. Üretim şeklinizi optimumlaştırarak pazar pozisyonunuzu kuvvetlendirir. Böylece faaliyet gösterdiğiniz pazarda rakiplerinize karşı avantajlar sağlarsınız.

RockStar® Sanayi Tipi Fiş - Soket Kitleri — Kolay Seçim İçin

RockStar® Kit'leri kendinizin monte edebileceği parçalardan oluşur. Tüm gerekli parçaları içinde bulunduran Kit'ler sanayi tipi fiş soketleri tek bir sipariş numarasında bir araya getirir. RockStar® Kit'ler, fiş soketler, pinler, fiş kutuları, priz kutuları ve kablo rakorlarını içerirler.

Avantajları:

- Kolay seçim
- Kolay tasarım
- Kolay depolama

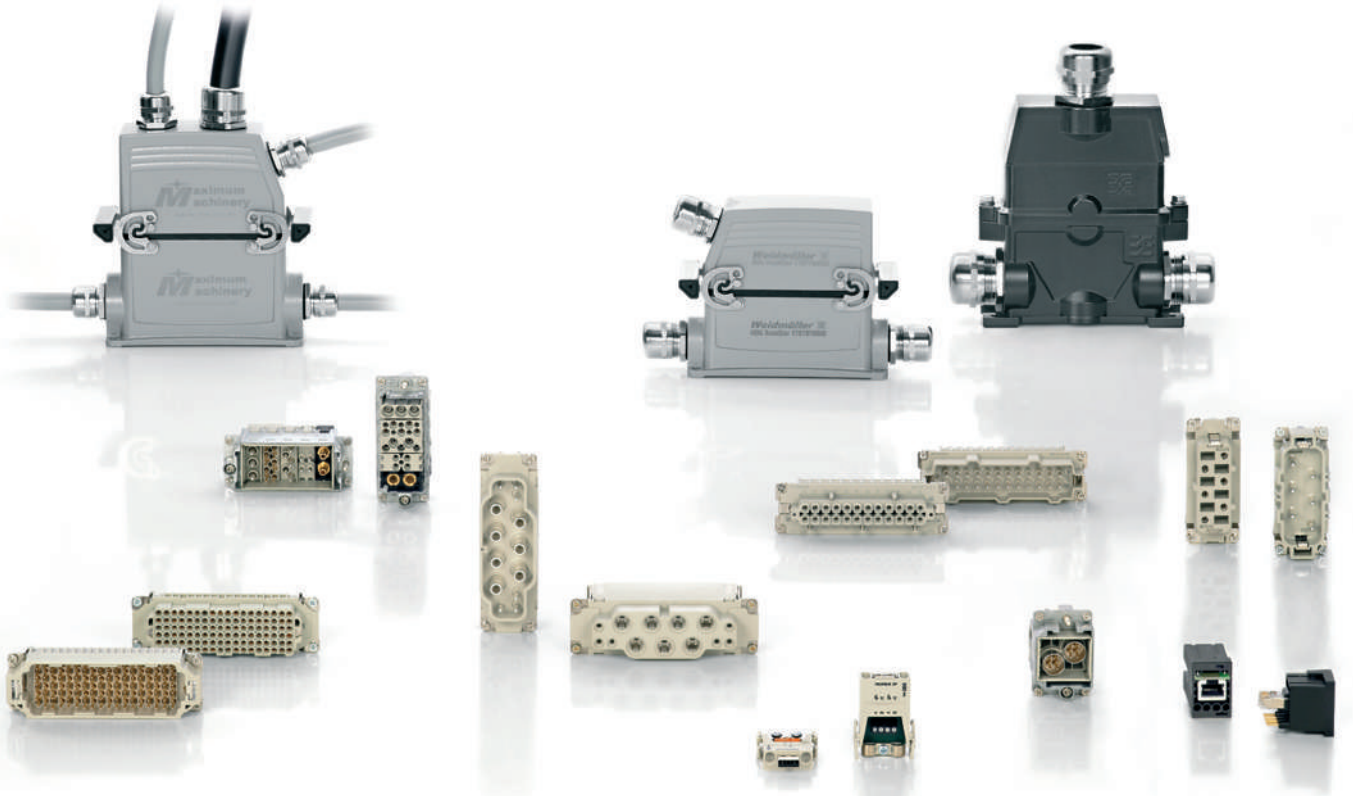



HDC-KIT-HE 10.111



HDC HE 6 MS



HDC HE 10 MS



HDC HE 10 MT



HDC 10B TOBU 1PG16G



HDC 10B TSBU 1PG16G



HDC HE 16 MS

Tip	V / A	Kutup Sayısı	Sipariş No	Fiyat/Birim	Ambalaj
HE Serisi Komple Sanayi Tipi Fiş-Soketler (Kit'ler)					
Yukardan Rakorlu					
HDC-KIT-HA 03.300	500 V / 24 A	3-kutup(Metal Kutu)	1712560000	176,10 TL	1
HDC-KIT-HA 03.301	250 V / 22 A	3-kutup(Plastik Kutu)	1712570000	220,00 TL	1
HDC-KIT-HA 04.400	250 V / 22 A	4-kutup(Metal Kutu)	1712590000	185,85 TL	1
HDC-KIT-HA 04.401	250 V / 22 A	4-kutup(Plastik Kutu)	1712600000	167,65 TL	1
HDC-KIT-HE 06.101	500 V / 24 A	6-kutup(Metal Kutu)	1712660000	330,00 TL	1
HDC-KIT-HE 10.111	500 V / 16 A	10-kutup(Metal Kutu)	1712670000	420,00 TL	1
HDC-KIT-HE 16.121	500 V / 16 A	16-kutup(Metal Kutu)	1712680000	476,95 TL	1
HDC-KIT-HE 24.131	500 V / 16 A	24-kutup(Metal Kutu)	1712690000	517,00 TL	1
Yandan Rakorlu					
HDC-KIT-HE 06.100	500 V / 24 A	6-kutup(Metal Kutu)	1712460000	279,00 TL	1
HDC-KIT-HE 10.110	500 V / 16 A	10-kutup(Metal Kutu)	1712510000	376,30 TL	1
HDC-KIT-HE 16.120	500 V / 16 A	16-kutup(Metal Kutu)	1712520000	479,80 TL	1
HDC-KIT-HE 24.130	500 V / 16 A	24-kutup(Metal Kutu)	1712530000	521,00 TL	1
HDC-KIT-HE 32.140	400 V / 16 A	32-kutup(Metal Kutu)	1712540000	990,00 TL	1
HDC-KIT-HE 48.150	500 V / 16 A	48-kutup(Metal Kutu)	1712550000	1.380,00 TL	1
HE - Tipi Fiş-Soketler (Vidalı / yaylı bağlantı) / Universal Konnektörler					
6 Kutup					
HDC HE 6 MS	500 V / 24 A	6 kutup (Fiş)	1200000000	58,25 TL	1
HDC HE 6 FS	500 V / 24 A	6 kutup (Soket)	1200200000	58,25 TL	1
HDC HE 6 MT	500 V / 24 A	6 kutup (Fiş)	1745820000	58,25 TL	1
HDC HE 6 FT	500 V / 24 A	6 kutup (Soket)	1745760000	58,25 TL	1
HDC 06B TOLU 1PG16G		Yukarıdan Rakorlu	1652640000	71,70 TL	1
HDC 06B TSLU 1PG16G		Yandan Rakorlu	1652520000	71,70 TL	1
HDC 06B ALU		Makina Tipi	1202100000	68,45 TL	1
* HDC 06B ALU N		Makina Tipi	2488560000	75,35 TL	1
HDC 06B SLU 1PG16G		Duvar Tipi	1652750000	106,65 TL	1
HDC 06B KLU 1PG16G		Seyyar Tip	1653200000	144,00 TL	1
* HDC 06B DODL 2B0	Koruma Kapağı		1665200000	110,20 TL	1
10 Kutup					
HDC HE 10 MS	500 V / 16 A	10 kutup (Fiş)	1203900000	58,25 TL	1
HDC HE 10 FS	500 V / 16 A	10 kutup (Soket)	1204100000	58,25 TL	1
HDC HE 10 MT	500 V / 16 A	10 kutup (Fiş)	1745830000	77,35 TL	1
HDC HE 10 FT	500 V / 16 A	10 kutup (Soket)	1745770000	77,35 TL	1
HDC 10B TOBU 1PG16G		Yukarıdan Rakorlu	1654220000	101,10 TL	1
HDC 10B TSBU 1PG16G		Yandan Rakorlu	1654070000	101,10 TL	1
HDC 10B ABU		Makina Tipi	1205000000	104,35 TL	1
* HDC 10B ABU N		Makina Tipi	2488580000	110,85 TL	1
HDC 10B SBU 1PG16G		Duvar Tipi	1654370000	160,70 TL	1
HDC 10B KBU 1PG16G		Seyyar Tip	1654580000	133,20 TL	1
* HDC 10B DODQ 4B0	Koruma Kapağı		1665230000	97,70 TL	1
16 Kutup					
HDC HE 16 MS	500 V / 16 A	16 kutup (Fiş)	1207500000	87,10 TL	1
HDC HE 16 FS	500 V / 16 A	16 kutup (Soket)	1207700000	87,10 TL	1
HDC HE 16 MT	500 V / 16 A	16 kutup (Fiş)	1745840000	102,45 TL	1
HDC HE 16 FT	500 V / 16 A	16 kutup (Soket)	1745780000	102,45 TL	1
HDC 16B TOBU 1PG21G		Yukarıdan Rakorlu	1656590000	106,65 TL	1
HDC 16B TSBU 1PG21G		Yandan Rakorlu	1656480000	104,35 TL	1
HDC 16B ABU		Makina Tipi	1208600000	104,35 TL	1

Serinin devamı sayfa 55



HDC HE 24 MS



HDC HE 16 MS



HDC HE 16 MT



HDC 32B TOBU 1PG29G



HDC HDD 24 MC



CTX CM 1.6/2.5

Tip	V / A	Kutup Sayısı	Sipariş No	Fiyat/Birim	Ambalaj
* HDC 16B ABU N		Makina Tipi	2488590000	115,35 TL	1
HDC 16B SBU 1PG21G		Duvar Tipi	1656720000	169,00 TL	1
HDC 16B KBU 1PG21G		Seyyar Tip	1657270000	142,10 TL	1
* HDC 16B DODQ 4B0	Koruma Kapağı		1665260000	122,20 TL	1
24 Kutup					
HDC HE 24 MS	250 V / 22 A	24 kutup (Fiş)	1211100000	124,35 TL	1
HDC HE 24 FS	250 V / 22 A	24 kutup (Soket)	1211300000	124,35 TL	1
HDC HE 24 MT	500 V / 16 A	24 kutup (Fiş)	1745850000	124,35 TL	1
HDC HE 24 FT	500 V / 16 A	24 kutup (Soket)	1745790000	124,35 TL	1
HDC 24B TOBU 1PG21G		Yukarıdan Rakorlu	1661370000	114,15 TL	1
HDC 24B TSBV 1PG21G		Yandan Rakorlu	1661230000	114,15 TL	1
HDC 24B ABU		Makina Tipi	1212400000	117,85 TL	1
* HDC 24B ABU N		Makina Tipi	2488600000	123,10 TL	1
HDC 24B SBU 1PG21G		Duvar Tipi	1661510000	193,70 TL	1
HDC 24B KBU 1PG21G		Seyyar Tip	1661720000	171,85 TL	1
HDC 24B DODQ 4B0	Koruma Kapağı		1665630000	150,30 TL	1
32 Kutup					
HDC HE 16 MS	500 V / 16 A	16 kutup (Fiş)	1207500000	87,10 TL	1
HDC HE 16 MS 17-32	500 V / 16 A	32 kutup (Fiş)	1215700000	96,85 TL	1
HDC HE 16 FS	500 V / 16 A	16 kutup (Soket)	1207700000	87,10 TL	1
HDC HE 16 FS 17-32	500 V / 16 A	32 kutup (Soket)	1216100000	99,20 TL	1
HDC HE 16 MT	500 V / 16 A	16 kutup (Fiş)	1745840000	102,45 TL	1
HDC HE 16 MT 17-32	500 V / 16 A	32 kutup (Fiş)	1745860000	100,10 TL	1
HDC HE 16 FT	500 V / 16 A	16 kutup (Soket)	1745780000	102,45 TL	1
HDC HE 16 FT 17-32	500 V / 16 A	32 kutup (Soket)	1745800000	100,10 TL	1
HDC 32B TOBU 1PG29G		Yukarıdan Rakorlu	1666870000	283,15 TL	1
HDC 32B TSBV 1PG29G		Yandan Rakorlu	1666840000	290,10 TL	1
HDC 32B ABU		Makina Tipi	1217800000	233,35 TL	1
HDC 32B SBU 2PG29G		Duvar Tipi	1666920000	326,00 TL	1
HDC 32B KBU 1PG29G		Seyyar Tip	1902740000	460,60 TL	1
HDD Serisi (Çoklu Crimp Bağlantı)					
24 Kutup					
HDC HDD 24 MC	250 V / 10 A	24 kutup (Fiş)	1651150000	118,75 TL	1
HDC HDD 24 FC	250 V / 10 A	24 kutup (Soket)	1651160000	118,35 TL	1
HDC 06B TOLU 1PG16G		Yukarıdan Rakorlu	1652640000	71,70 TL	1
HDC 06B TSLU 1PG16G		Yandan Rakorlu	1652520000	71,70 TL	1
HDC 06B ALU		Makina Tipi	1202100000	68,45 TL	1
* HDC 06B ALU N		Makina Tipi	2488560000	75,35 TL	1
HDC 06B SLU 1PG16G		Duvar Tipi	1652750000	106,65 TL	1
HDC 06B KLU 1PG16G		Seyyar Tip	1653200000	144,00 TL	1
Tip					
Açıklama					
Sipariş No					
Fiyat/Birim					
Ambalaj					
HDD Serisi (Çoklu Crimp Bağlantı)					
Aksesuarlar					
HDC-C-HD-BM0.75-1.00AG	0.75- 1.00 kablo kesiti / Dişi		1601760000	5,60 TL	100
HDC-C-HD-SM1.5AG	1.5 kablo kesiti / Erkek		1651550000	5,60 TL	100
CTX CM 1.6/2.5	Crimp kontak sıkma el aleti / 0.14mm ² ... 4mm ²		9018490000	5.068,00 TL	1

Rockstar Sanayi Tipi Fiş-Soket



HDC HDD 42 MC



HDC 10B TOBU 1PG16G



HDC 10B TSBU 1PG16G



HDC HDD 72 MC



HDC HDD 108 MC



HDC-C-HD-SM0.75-1.00AG

Tip	V / A	Kutup Sayısı	Sipariş No	Fiyat/Birim	Ambalaj
HDD Serisi (Çoklu Crimp Bağlantı)					
42 Kutup					
HDC HDD 42 MC	250 V / 10 A	42 kutup Fiş	1651170000	130,40 TL	1
HDC HDD 42 FC	250 V / 10 A	42 kutup Soket	1651180000	130,40 TL	1
HDC 10B TOBU 1PG16G		Yukarıdan Rakorlu	1654220000	101,10 TL	1
HDC 10B TSBU 1PG16G		Yandan Rakorlu	1654070000	101,10 TL	1
HDC 10B ABU		Makina Tipi	1205000000	104,35 TL	1
* HDC 10B ABU N		Makina Tipi	2488580000	110,85 TL	1
HDC 10B SBU 1PG16G		Duvar Tipi	1654370000	160,70 TL	1
HDC 10B KBU 1PG16G		Seyyar Tip	1654580000	133,20 TL	1

Tip	Açıklama	Sipariş No	Fiyat/Birim	Ambalaj
HDD Serisi (Çoklu Crimp Bağlantı)				
Aksesuarlar				
REMOVAL TOOL HD	Sökme Aparatı	1866730000	489,50 TL	1

Tip	V / A	Açıklama	Sipariş No	Fiyat/Birim	Ambalaj
HDD Serisi (Çoklu Crimp Bağlantı)					
72 Kutup					
HDC HDD 72 MC	250 V / 10 A	72 Kutup fiş	1651190000	134,60 TL	1
HDC HDD 72 FC	250 V / 10 A	72 Kutup soket	1651200000	134,60 TL	1
HDC 16B TOBU 1PG21G		Yukarıdan Rakorlu	1656590000	106,65 TL	1
HDC 16B TSBU 1PG21G		Yandan Rakorlu	1656480000	104,35 TL	1
HDC 16B ABU		Makina Tipi	1208600000	104,35 TL	1
* HDC 16B ABU N		Makina Tipi	2488590000	115,35 TL	1
HDC 16B SBU 1PG21G		Duvar Tipi	1656720000	169,00 TL	1
HDC 16B KBU 1PG21G		Seyyar Tip	1657270000	142,10 TL	1

Tip	Açıklama	Sipariş No	Fiyat/Birim	Ambalaj
HDD Serisi (Çoklu Crimp Bağlantı)				
Aksesuarlar				
HDC-C-HD-BM1.5AG	1.5 kablo kesiti / Dişi	1651600000	5,60 TL	100

Tip	V / A	Açıklama	Sipariş No	Fiyat/Birim	Ambalaj
HDD Serisi (Çoklu Crimp Bağlantı)					
108 Kutup					
HDC HDD 108 MC	250 V / 10 A	108 Kutup fiş	1651210000	144,85 TL	1
HDC HDD 108 FC	250 V / 10 A	108 Kutup soket	1651220000	144,85 TL	1
HDC 24B TOBU 1PG21G		Yukarıdan Rakorlu	1661370000	114,15 TL	1
HDC 24B TSBU 1PG21G		Yandan Rakorlu	1661230000	114,15 TL	1
HDC 24B ABU		Makina Tipi	1212400000	117,85 TL	1
* HDC 24B ABU N		Makina Tipi	2488600000	123,10 TL	1
HDC 24B SBU 1PG21G		Duvar Tipi	1661510000	193,70 TL	1
HDC 24B KBU 1PG21G		Seyyar Tip	1661720000	171,85 TL	1

Tip	Açıklama	Sipariş No	Fiyat/Birim	Ambalaj
HDD Serisi (Çoklu Crimp Bağlantı)				
Aksesuarlar				
HDC-C-HD-SM0.75-1.00AG	0.75- 1.00 kablo kesiti / Erkek	1601750000	5,60 TL	100
HDC-C-HD-SM2.5AG	2.5 kablo kesiti / Erkek	1651560000	5,60 TL	100
HDC-C-HD-BM2.5AG	2.5 kablo kesiti / Dişi	1651610000	5,60 TL	100



HDC HSB 6 MS



HDC 32B TOBU 1PG29G



HDC IP68 HP 24B TO



HDC IP68 HP 24B A



HDC IP68 HP 24B TO



HDC IP68 HP 24B A



STV S 2 SS

Tip	V / A	Kutup Sayısı	Sipariş No	Fiyat/Birim	Ambalaj
HSB - Tipi Güç Konnektörleri					
6 Kutup					
HDC HSB 6 MS	400 V / 35 A	6 kutup (Fiş)	1498700000	192,85 TL	1
HDC HSB 6 FS	400 V / 35 A	6 kutup (Soket)	1498900000	217,95 TL	1
HDC 16B TOBU 1PG21G		Yukarıdan Rakorlu	1656590000	106,65 TL	1
HDC 16B TSBU 1PG21G		Yandan Rakorlu	1656480000	104,35 TL	1
HDC 16B ABU		Makina Tipi	1208600000	104,35 TL	1
* HDC 16B ABU N		Makina Tipi	2488590000	115,35 TL	1
HDC 16B SBU 1PG21G		Duvar Tipi	1656720000	169,00 TL	1
HDC 16B KBU 1PG21G		Seyyar Tip	1657270000	142,10 TL	1
12 Kutup					
HDC HSB 6 MS	400 V / 35 A	6 kutup (Fiş)	1498700000	192,85 TL	1
HDC HSB 6 MS 7 - 12	400 V / 35 A	12 kutup (Fiş)	1498800000	192,85 TL	1
HDC HSB 6 FS	400 V / 35 A	6 kutup (Soket)	1498900000	217,95 TL	1
HDC HSB 6 FS 7 - 12	400 V / 35 A	12 kutup (Soket)	1499000000	217,95 TL	1
HDC 32B TOBU 1PG29G		Yukarıdan Rakorlu	1666870000	283,15 TL	1
HDC 32B TSBU 1PG29G		Yandan Rakorlu	1666840000	290,10 TL	1
HDC 32B ABU		Makina Tipi	1217800000	233,35 TL	1
HDC 32B SBU 2PG29G		Duvar Tipi	1666920000	326,00 TL	1
HDC 32B KBU 1PG29G		Seyyar Tip	1902740000	460,60 TL	1
HDC - HP Tipi 250A / 550A GÜÇ KONNEKTÖRLERİ					
250 A / 4000 V					
HDC IP68 HP 24B TO		Fiş Koruma Kılıfı	1079930000	878,00 TL	1
HDC IP68 HP 24B AS S		Sabit Fiş Koruma Kılıfı	1079920000	1.257,00 TL	1
HDC IP68 HP 24B A		Makine Tipi	1120040000	450,35 TL	1
HDC IP68 24B HP FRAME		Çerçeve	1282820000	364,65 TL	1
550 A / 4000 V					
HDC IP68 HP 24B TO		Fiş Koruma Kılıfı	1079930000	878,00 TL	1
HDC IP68 HP 24B AS S		Sabit Fiş Koruma Kılıfı	1079920000	1.257,00 TL	1
HDC IP68 HP 24B A		Makine Tipi	1120040000	450,35 TL	1
HDC IP68 24B HP FRAME		Çerçeve	1282820000	364,65 TL	1
Aksesuarlar					
Crimp Contact			Sorunuz	Sorunuz	1
EMC-Shield Lever			Sorunuz	Sorunuz	1
Touch-Safe Protection Safe			Sorunuz	Sorunuz	1
Mounting Frame			Sorunuz	Sorunuz	1
Cable Glands			Sorunuz	Sorunuz	1
Fiş-Soket Klemensleri (STV S Tipi)					
STV S 2 SS		2 Kutuplu Fiş	1611950000	28,00 TL	10
STV S 2 SB		2 Kutuplu Soket	1611960000	35,00 TL	10
STV S 3 SS		3 Kutuplu Fiş	1611980000	30,80 TL	10
STV S 3 SB		3 Kutuplu Soket	1611990000	44,20 TL	10
STV S 4 SS		4 Kutuplu Fiş	1612010000	46,60 TL	10
STV S 4 SB		4 Kutuplu Soket	1612020000	59,15 TL	10
STV S 5 SS		5 Kutuplu Fiş	1612040000	70,35 TL	10
STV S 5 SB		5 Kutuplu Soket	1612050000	70,80 TL	10
STV S 6 SS		6 Kutuplu Fiş	1612070000	50,00 TL	10
STV S 6 SB		6 Kutuplu Soket	1612080000	76,00 TL	10
STV S 8 SS		8 Kutuplu Fiş	1612130000	69,00 TL	10

Serinin devamı sayfa 58

Rockstar Sanayi Tipi Fiş-Soket

Tip	Açıklama	Sipariş No	Fiyat/Birim	Ambalaj
STV S 8 SB	8 Kutuplu Soket	1612140000	99,00 TL	10
STV S 9 SS	9 Kutuplu Fiş	1612160000	85,00 TL	10
STV S 9 SB	9 Kutuplu Soket	1612170000	105,00 TL	10
STV S 10 SS	10 Kutuplu Fiş	1612190000	73,60 TL	10
STV S 10 SB	10 Kutuplu Soket	1612200000	109,40 TL	10

Fiş-Soket Klemensleri (STV-STW Tipi)

STV 2/10 S/B	Komple	644960000	192,40 TL	10
STV 2/10 LB 90 3.2	Lehim pinli, Soket	1305360000	131,35 TL	10
STV 2/10 LS 90 3.2	Lehim pinli, Fiş	1305760000	81,95 TL	10
STW 2/20/D S/B TS ZE	Raya monte edilebilir	1268360000	649,00 TL	5
STW 2/20/C S/B TS ZE	Raya monte edilebilir	291660000	649,00 TL	5

Tip	Açıklama	SW1 / SW2	Sipariş No	Fiyat/Birim	Ambalaj
Plastik Rakorlar IP 67					
VG PG11-K67	PG 11	22	1909780000	5,00 TL	50
VG PG16-K67	PG 16	27	1909800000	5,65 TL	50
VG PG21-K67	PG 21	33	1909810000	8,05 TL	25
VG PG29-K67	PG 29	42	1909820000	17,30 TL	20

Metal Rakorlar IP 67					
VG 11-MS68	Kablo Rakoru-PG11-IP68	20	1569080000	30,30 TL	50
VG 16-MS68	Kablo Rakoru-PG16-IP68	24	1569100000	39,60 TL	25
VG 21-MS68	Kablo Rakoru-PG21-IP68	30	1569110000	65,70 TL	25
VG 29-MS68	Kablo Rakoru-PG29-IP68	40	1569120000	103,40 TL	10



VG PG11-K67

El Aletleri

Hidrolik Skp Pabuç Sıkma Ürünleri

Skp pabuç sıkma ailesinin yeni üyeleri tamamen hidrolik çalışma prensibi ile güç sarfiyatını en aza düşürüyor. Tüm kesit aralıklarında, farklı sıkma şekillerini destekleyen çene yapılarıyla beraber bakır ve alüminyum hem izoleli hem izolesiz pabuçlar için çözümler sunmaktadır. Manuel ve otomatik olarak her el aleti için iki farklı opsiyon bulunmaktadır.

Kesme

Weidmüller kesme aletleri profesyonel kablo işçiliğinin bütün kriterlerini yerine getirir. Tüm kesme aletleri için istenen iletken formunu bozmadan, düz ve pürüzsüz bir kesimdir. Her türlü iletken kesimi için gerekli el aletini Weidmüller ürün ailesi içerisinde bulabilirsiniz.

Kablo Soyma

Kablo soyma, iletkenin dış izolasyonunun sıyrılıp alınması anlamına gelir. Soyma esnasında şunlar garantilenmelidir: Soyma ölçüsü dikkate alınmalı ve iletkene zarar vermemelidir. Aynı şart geride kalan izolasyon için de geçerlidir.

Sıkma

İzolasyonu soyulan kablo ucuna yüksek pabuç yada özel bağlantı konnetörleri elektriksel ve mekaniksel kriterlere uygun olarak sıkıştırılır. Weidmüller sıkma aletleri kablo uçlarını sıkmak için çok geniş bir ürün ailesine sahiptir.

Klemens Tornavidaları

Tornavidaların sap yapısı, kullanıcının tutuş konforu göz önünde bulundurularak sürekli geliştirme sonunda özel olarak tasarlanmıştır. Çeşitli çalışma tarzlarına uygundur.

Test ve Ölçü Aletleri

Test ve ölçü aletleri elektrik tesislerinin yapım ve bakımı ve tamirinde büyük önem taşırlar. Weidmüller'in ürün ailesi ile standartlara uygun şekilde test ve ölçüm yapabilirsiniz.

Takım Çantaları

Elektrik, Elektronik ve otomasyon işçiliğinde kullanım için değişik ihtiyaçlara yönelik kombine edilmiş profesyonel el aletleri setlerinden oluşur.





KT 8



KT 55



TSLD 5



STRIPAX 16



AM 12



STRIPAX PLUS 2.5

Tip	Açıklama	Sipariş No	Fiyat/Birim	Ambalaj
Kablo Kesme				
KT 8	8 mm max. Çap/Örgü kesit:16mm ² /Çok Damarlı kesit:16mm ² /Tek Damarlı Kesit:16mm ²	9002650000	492,75 TL	1
KT 12	12 mm max. Çap/Örgü kesit:25mm ² /Çok Damarlı kesit:35mm ² /Tek Damarlı Kesit:16mm ²	9002660000	535,00 TL	1
KT 14	14 mm max. Çap/Örgü kesit:35mm ² /Çok Damarlı kesit:70mm ² /Tek Damarlı Kesit:16mm ²	1157820000	589,00 TL	1
KT 22	22 mm max. Çap/Örgü kesit:50mm ² /Çok Damarlı kesit:95mm ² /Tek Damarlı Kesit:25mm ²	1157830000	730,00 TL	1
KTF 25	25 mm max. Çap/Örgü kesit:120mm ² /Çok Damarlı kesit:120mm ²	9002180000	5.068,00 TL	1
KTF 36	35 mm max. Çap/Örgü kesit:300mm ² /Çok Damarlı kesit:300mm ²	9002190000	7.017,00 TL	1
KT 45 R	45 mm max. Çap/Örgü kesit:300mm ² /Çok Damarlı kesit:400mm ²	9202040000	5.848,00 TL	1
KT 55	55 mm max. Çap/Örgü kesit:500mm ² /Çok Damarlı kesit:500mm ²	9202060000	8.502,00 TL	1
KT 80	80 mm max. Çap/Örgü kesit:630mm ² /Çok Damarlı kesit:630mm ²	9202080000	16.047,00 TL	1
Üst Köprü, Kanal ve Ray Kesme				
WAW 1 NEUTRAL	WQV 2.5 ile WQV 35 arasındaki üst köprüleri kesmek için	9004500000	750,00 TL	1
WAW 2	Klemens Köprü Açma El Aleti	9004510000	743,00 TL	1
KT ZQV	Z serisi üst köprüleri kırma/kesme el aleti	9002170000	429,65 TL	1
VKSW	Kanal Kesme Makinası (125mm genişliğe kadar olan kablo kanalları için)	1137530000	1.755,00 €	1
TSLD 5	Ray Kesme Makinası	9918700000	3.370,00 €	1
Kablo Soyma				
STRIPAX	0,08...10mm ² arası kesit PVC kablolar için kesme ve soyma	9005000000	770,00 TL	1
ERME 10 ² SPX 4	Stripax için yedek bıçak	1119030000	234,90 TL	1
STRIPAX 16	6...16mm ² arası kesit PVC kablolar için	9005610000	1.951,00 TL	1
ERME 16 ² SPX 4	Stripax 16 için yedek bıçak	1119040000	468,20 TL	1
STRIPAX ULTIMATE	Halogen Free Kablolar İçin 0.25...6 mm ² arası kesitler için	1468880000	914,00 TL	1
STRIPAX ULTIMATE XL	Halogen Free Kablolar İçin 2.5...10 mm ² arası kesitler için	1512780000	1.102,00 TL	1
multi-stripax 6-16	6, 10, 16 mm ² kesite sahip sert ve yumuşak izolasyonlu kablolar için	9202210000	3.814,00 TL	1
AM 12	0.5...12.5mm çap aralığına sahip UTP ve STP data kabloları için	9030060000	416,75 TL	1
AM 16	6...17 mm çap aralığına sahip PVC kablolar için	9204190000	975,00 TL	1
AM 25	6...25mm çap aralığına sahip PVC kablolar için	9001540000	721,00 TL	1
AM 35	25...36mm çap aralığına sahip PVC kablolar için	9001080000	721,00 TL	1
AMF 6/10	0...4.0 mm çap aralığına sahip PVC şerit kablolar için	9204180000	760,00 TL	1
IE-CST	2.5...8 mm çap aralığına sahip Coaxial ve Data kablolar için	9204350000	898,00 TL	1
CST	2.5...8 mm çap aralığına sahip Coaxial ve Data kablolar için	9030500000	654,00 TL	1
CST Cassette	CST İçin Bıçak Kaseti, Çeşitleri İçin Bilgi Alınız	9032xx0000	Sorunuz	Sorunuz
CST VARIO	2.5...8 mm çap aralığına sahip Coaxial ve Data kablolar için	9005700000	1.088,00 TL	1
IE-CST Weidmüller Ethernet kablosuna göre ayarlanmış bıçak kasetini içermektedir. CST ürünü herhangi bir bıçak kaseti içermemektedir.Ek olarak seçilip sipariş edilmelidir.				
Yüksük Sıkma				
STRIPAX PLUS 2.5	0,5...2,5mm ² kesit aralığına sahip PVC kablolar için Kesme,Soyma ve Sıkma	9020000000	2.576,00 TL	1
PZ 1.5	0.14...1.5mm ² kesit aralığında V tipi sıkma	9005990000	1.833,00 TL	1
PZ 10 HEX	0.14...10mm ² kesit aralığında tek yuvada hexagonal sıkma	1445070000	2.974,00 TL	1
PZ 10 SQR	0.14...10mm ² kesit aralığında tek yuvada kare sıkma	1445080000	2.444,00 TL	1
PZ 6/5	0.25...6mm ² kesit aralığında 5 farklı yuvada W tipi sıkma	9011460000	2.527,00 TL	1
PZ 6 Roto	0.14...6mm ² kesit aralığında tek yuvada V tipi sıkma-Dönebilen	9014350000	2.233,00 TL	1
PZ 6 ROTO L	0.14...6mm ² kesit aralığında tek yuvada V tipi sıkma-Dönebilen,Kitlenebilir çene	1444050000	2.233,00 TL	1
PZ 16	6...16mm ² kesit aralığında 3 farklı yuvada W tipi sıkma	9012600000	2.527,00 TL	1
PZ 50	25...50mm ² kesit aralığında 3 farklı yuvada W tipi sıkma	9006450000	3.888,00 TL	1



HTF 63



CTI 6 G



HTN 21



TT 864 RS



APG 80



IE-KO-HAT

Tip	Açıklama	Sipariş No	Fiyat/Birim	Ambalaj
Faston Papuç Sıkma				
HTF 28	0.1...1mm ² kesit aralığında pabuç bağlantı genişliği:2.8mm	9013090000	3.645,00 TL	1
HTF 48	0.5...2.5mm ² kesit aralığında pabuç bağlantı genişliği:4.8mm	9013080000	3.645,00 TL	1
HTF 63	0.5...2.5mm ² kesit aralığında pabuç bağlantı genişliği:6.3mm	9013400000	3.745,00 TL	1
CTF 63	0,5...6mm ² kesit aralığında pabuç bağlantı genişliği:6.3mm	9202860000	5.770,00 TL	1
İzoleli Papuç Sıkma				
CTI 6 G	0,5...6 mm ² kesit aralığında Amerika standardına uygun paralel sıkma	9202850000	2.479,00 TL	1
CTI 6	0,5...6 mm ² kesit aralığında Avrupa standardına uygun çift sıkma	9006120000	2.479,00 TL	1
HTI 15	0.5...2.5 mm ² kesit aralığında Avrupa standardına uygun çift sıkma	9014400000	1.805,00 TL	1
İzolesiz Papuç Sıkma				
HTN 21	0.5...6 mm ² kesit aralığında (nokta baskı sıkma)	9014610000	2.479,00 TL	1
CTN 25 D4	10...25 mm ² kesit aralığında yuvarlak tip crimp kontak sıkma (nokta baskı sıkma)	9006220000	3.409,00 TL	1
CTN 25 D5	10...25 mm ² kesit aralığında yuvarlak tip crimp kontak sıkma (paralel hexagonal baskı sıkma)	9006230000	3.409,00 TL	1
Crimp Kontak Sıkma				
CTX CM 1.6/2.5	Crimp kontak sıkma el aleti / 0.14mm ² ... 4mm ²	9018490000	5.068,00 TL	1
CTX CM 3.6	4...10 mm ² kesit aralığında yuvarlak HD ve Concept M3 kontaklar için	9018480000	5.068,00 TL	1
CTIN CM 1.6/2.5	0.14...4 mm ² kesit aralığında yuvarlak HD,HE,HX ve M10,M5,M3 kontaklar için(Elektronk Kontrol)	9205430000	14.820,00 TL	1
CTIN CM 3.6	1,5...10 mm ² kesit aralığında yuvarlak HX ve M3 kontaklar için(Elektronk Kontrol)	9205440000	14.820,00 TL	1
HTX LWL	Fiber Optik Konnektör Sıkma	9011360000	3.043,00 TL	1
Data ve Tel. Konnektör Sıkma				
TT 864 RS	4,6 ve 8 pin sıkma	9008120000	2.670,00 TL	1
TT 1064 RS	4,6 ve 10 pin sıkma	9008190000	3.800,00 TL	1
SKP Papuç Sıkma - MTR				
APG 80	6 - 300 mm ² Hidrolik Papuç Sıkma Aleti (Şarjlı Otomatik)	1502390000	36.457,00 TL	1
* APG 55	6 - 240 mm ² Hidrolik Papuç Sıkma Aleti (Otomatik Şarjlı)	1501390000	29.445,00 TL	1
ES APG/HPG80 HEX 6	6 mm ² Çene - Bakır Pabuçlar İçin	1502600000	1.416,00 TL	1
ES APG/HPG80 HEX 10	10 mm ² Çene - Bakır Pabuçlar İçin	1502620000	1.416,00 TL	1
ES APG/HPG80 HEX 16	16 mm ² Çene - Bakır Pabuçlar İçin	1502630000	1.416,00 TL	1
ES APG/HPG80 HEX 25	25 mm ² Çene - Bakır Pabuçlar İçin	1502640000	1.416,00 TL	1
ES APG/HPG80 HEX 35	35 mm ² Çene - Bakır Pabuçlar İçin	1502650000	1.416,00 TL	1
ES APG/HPG80 HEX 50	50 mm ² Çene - Bakır Pabuçlar İçin	1502670000	1.416,00 TL	1
ES APG/HPG80 HEX 70	70 mm ² Çene - Bakır Pabuçlar İçin	1502680000	1.416,00 TL	1
ES APG/HPG80 HEX 95	95 mm ² Çene - Bakır Pabuçlar İçin	1502690000	1.416,00 TL	1
ES APG/HPG80 HEX 120	120 mm ² Çene - Bakır Pabuçlar İçin	1502700000	1.416,00 TL	1
ES APG/HPG80 HEX 150	150 mm ² Çene - Bakır Pabuçlar İçin	1502720000	1.416,00 TL	1
ES APG/HPG80 HEX 185	185 mm ² Çene - Bakır Pabuçlar İçin	1502730000	1.416,00 TL	1
ES APG/HPG80 HEX 240	240 mm ² Çene - Bakır Pabuçlar İçin	1502740000	1.416,00 TL	1
ES APG/HPG80 HEX 300	300 mm ² Çene - Bakır Pabuçlar İçin	1502750000	1.571,00 TL	1
Kablo Bağlı Sıkma				
KABELBINDERZANGE RT-1	2.5...4.8 mm genişliğinde ve max. 1.6 mm kalınlığında plastik kablo bağları için	1296000000	548,00 TL	1
WSM TOOL AUTOMATİK	4.6 mm genişliğinde çelik kablo bağları için	1774470000	1.326,00 TL	1
WSM TOOL MANUELL	4.6 mm genişliğinde çelik kablo bağları için	1774480000	6.633,00 TL	1
Hidrolik Punch				
IE-KO-HAT	Hidrolik Punch	1966810000	10.706,00 TL	1
Not: Metrik,PG,Ethernet,HDC,Kablo ve Vida Vb... Çene Aksesuarları için Lütfen Bilgi Alınız.				



SDIS 0.4X2.5X75



SDIS SL 0.6X3.5X100



SDS 0.4X2.0X60



SD Set S2.5-5.5/PH1/2



SWIFTY SET



DMS 3 SET 1



SK WSD-S 1,5-10,0

Tip	Açıklama	Sipariş No	Fiyat/Birim	Ambalaj
Klemens Tornavidaları - İzoleli (VDE) (1000 Volt)				
SDIS 0.4X2.5X75	Düz-(Uç Kalınlık x Uç Uzunluk x Boy Uzunluk)	9008370000	137,70 TL	1
SDIS 0.5X3.0X100	Düz-(Uç Kalınlık x Uç Uzunluk x Boy Uzunluk)	9008380000	144,20 TL	1
SDIS 0.6X3.5X100	Düz-(Uç Kalınlık x Uç Uzunluk x Boy Uzunluk)	9008390000	176,60 TL	1
SDIS 0.8X4.0X100	Düz-(Uç Kalınlık x Uç Uzunluk x Boy Uzunluk)	9008400000	176,60 TL	1
SDIS 1.0X4.5X125	Düz-(Uç Kalınlık x Uç Uzunluk x Boy Uzunluk)	9008910000	183,05 TL	1
SDIS 1.0X5.5X125	Düz-(Uç Kalınlık x Uç Uzunluk x Boy Uzunluk)	9008410000	217,10 TL	1
SDIK PH1	Yıldız-Size 1- Boy uzunluk: 80mm	9008570000	183,05 TL	1
SDIK PH2	Yıldız-Size 2- Boy uzunluk: 100mm	9008580000	218,70 TL	1
SDI SL S3.5-6.5/PH1/2	İzoleli tornavida seti- 4 Düz/2 Yıldız(İnce Seri)	1274750000	865,00 TL	1
SDIS SL 0.6X3.5X100	Düz-(Uç Kalınlık x Uç Uzunluk x Boy Uzunluk)(İnce Seri)	1274660000	126,35 TL	1
SDIS SL 0.8X4.0X100	Düz-(Uç Kalınlık x Uç Uzunluk x Boy Uzunluk)(İnce Seri)	1274670000	149,05 TL	1
SDIS SL 1.0X5.5X125	Düz-(Uç Kalınlık x Uç Uzunluk x Boy Uzunluk)(İnce Seri)	1274680000	179,80 TL	1
SDIS SL 1.2X6.5X150	Düz-(Uç Kalınlık x Uç Uzunluk x Boy Uzunluk)(İnce Seri)	1274690000	234,90 TL	1
SDIK PH1 SL	Yıldız-Size 1- Boy uzunluk: 80mm(İnce Seri)	1274710000	166,85 TL	1
SDIK PH2 SL	Yıldız-Size 2- Boy uzunluk: 100mm(İnce Seri)	1274720000	225,20 TL	1
SDIK PZ1 SL	Yıldız-Size 1- Boy uzunluk: 80mm(İnce Seri)	1274730000	192,80 TL	1
SDIK PZ2 SL	Yıldız-Size 2- Boy uzunluk: 100mm(İnce Seri)	1274740000	267,30 TL	1
SDI SL S3.5-6.5/PZ1/2	Yıldız-Size 1-2- Boy uzunluk:80-100mm(İnce Seri)	1445930000	926,00 TL	1
Klemens Tornavidaları - İzolesiz (VDE)				
SDS 0.4X2.0X60	Düz-(Uç Kalınlık x Uç Uzunluk x Boy Uzunluk)	9037160000	90,70 TL	1
SDS 0.4X2.5X75	Düz-(Uç Kalınlık x Uç Uzunluk x Boy Uzunluk)	9009030000	102,05 TL	1
SDS 0.5X3.0X80	Düz-(Uç Kalınlık x Uç Uzunluk x Boy Uzunluk)	9008320000	115,00 TL	1
SDS 0.6X3.5X100	Düz-(Uç Kalınlık x Uç Uzunluk x Boy Uzunluk)	9008330000	115,00 TL	1
SDS 0.6X3.5X200	Düz-(Uç Kalınlık x Uç Uzunluk x Boy Uzunluk)	9010110000	126,35 TL	1
SDS 0.8X4.0X100	Düz-(Uç Kalınlık x Uç Uzunluk x Boy Uzunluk)	9008340000	137,70 TL	1
SDS 0.8X4.5X125	Düz-(Uç Kalınlık x Uç Uzunluk x Boy Uzunluk)	9009020000	137,70 TL	1
SDS 1.0X5.5X150	Düz-(Uç Kalınlık x Uç Uzunluk x Boy Uzunluk)	9008350000	197,65 TL	1
SDS 1.2X6.5X150	Düz-(Uç Kalınlık x Uç Uzunluk x Boy Uzunluk)	9009010000	200,90 TL	1
SDK PH0	Yıldız-Size 0- Boy uzunluk: 60mm	9008470000	115,00 TL	1
SDK PH1	Yıldız-Size 1- Boy uzunluk: 80mm	9008480000	144,20 TL	1
SDK PH2	Yıldız-Size 2- Boy uzunluk: 100mm	9008490000	197,65 TL	1
SDK PH3	Yıldız-Size 3- Boy uzunluk: 150mm	9008500000	309,40 TL	1
SDK PZ1	Yıldız-Size 1- Boy uzunluk: 80mm (Pozidriv tip uç)	9008530000	150,65 TL	1
SDK PZ2	Yıldız-Size 2- Boy uzunluk: 100mm (Pozidriv tip uç)	9008540000	200,90 TL	1
SDK PZ3	Yıldız-Size 3- Boy uzunluk: 150mm (Pozidriv tip uç)	9008550000	312,65 TL	1
SD Set S2.5-5.5/PH1/2	İzolesiz tornavida seti- 4 Düz/2 Yıldız	9009740000	859,00 TL	1
SD Set S2.0-5.5	İzolesiz tornavida seti- 6 Düz	9205560000	859,00 TL	1
SYSTEM 11+1	Düz, Yıldız, Hex Tornavida Seti	9009750000	1.092,00 TL	1
Kablo Kesme Aparatı - Tornavida ve Kontrol Kalem				
SWIFTY SET	SD 0,6x3,5x100 tornavida ve kesme aparatı	9006060000	351,55 TL	1
SWIFTY	Kesme aparatı(uç genişliği 3.5mm ye kadar tornavidalar ve tek damarlı max. 1,5mm ² kesit kablo için)	9006020000	234,90 TL	1
SP 303	Kontrol Kalem	9006890000	24,30 TL	1
Şarjlı Tornavida				
DMS 3 SET 1	Komple Uçlar, Şarj Ünitesi Kutu İçinde	9007470000	4.485,00 TL	1
DMS 3 SET 2	Set 1+ Yedek Şarj Cihazı	9007480000	4.876,00 TL	1
Bit-Box WI DMS 3	Uç Seti	9024970000	351,55 TL	1
Allen Anahtar Setleri				
SK WSD-S 1,5-10,0	Size AF 1.5-2-2.5-3-4-5-6-8-10	9008850000	456,85 TL	1
SKS 2,0-8,0	Size Allen 2-2.5-3-4-5-6-8	9008860000	302,95 TL	1

Serinin devamı sayfa 63



CROSS-KEY MASTER



KBZ 160



KSE 160



FRZ SG 160



DIGI CHECK PRO



TEMPHASER



MG KIT CA 600



CRIMP-SET PZ 6 ROTO L

Tip	Açıklama	Sipariş No	Fiyat/Birim	Ambalaj
SKS 2,0-8,0 MR	Size Torx 2-2.5-3-4-5-6-8	9008870000	348,70 TL	1
TH-S 9-40	Size Torx 9-10-15-20-25-27-30-40	9008880000	390,40 TL	1

Pano Anahtar Setleri

CROSS-KEY MASTER	1X7 mm Düz/ PH 2 Yıldız/ 5,7,8 mm Kare/ 9 mm Üçgen/ 4 mm Allen	9918150000	241,40 TL	1
CROSS-KEY UNIVERSAL	1X7 mm Düz/ PH 2 Yıldız/ 5,7,8 mm Kare/ 9 mm Yuvarlak/ 4 mm Allen	9918130000	241,40 TL	1
CROSS-KEY UNIVERSAL S	1X7 mm Düz/ PH 2 Yıldız/ 5,8 mm Kare/ 9 mm Üçgen/ 4 mm Yuvarlak	9918140000	236,50 TL	1

Pense VDE İzoleli (1000 Volt)

KBZ 160	160 mm / 60 HRC	9046280000	341,80 TL	1
KBZ 180	180 mm / 60 HRC	9046290000	367,75 TL	1
KBZ 200	200 mm / 60 HRC	9046300000	396,90 TL	1
KBZI 200	200 mm / 60 HRC / Telefon Tesisatları İçin	9046430000	437,40 TL	1

Yan Keski VDE İzoleli (1000 Volt)

KSE 160	160 mm	9046410000	437,40 TL	1
KSE 200	200 mm	9046420000	440,65 TL	1
SE TOP	160 mm	9046340000	536,00 TL	1
SE HD 140	140 mm	9046310000	341,80 TL	1
SE HD 160	160 mm	9046320000	367,75 TL	1
SE HD 180	180 mm	9046330000	414,70 TL	1

Kargaburun VDE İzoleli (1000 Volt)

FRZ SG 160	160 mm / 45 / 60 HRC, 45 derece eğik uçlu	9046390000	392,40 TL	1
FRZ SG 200	200 mm / 45 / 60 HRC, 45 derece eğik uçlu	9046400000	396,90 TL	1
FRZ S 160	160 mm / 60 HRC	9046370000	345,05 TL	1
FRZ S 200	200 mm / 60 HRC	9046380000	351,55 TL	1
FZ 160	160 mm / Düz Uç	9046350000	317,50 TL	1
RZ 160	160 mm / Yuvarlak Uç	9046360000	317,50 TL	1

Test ve Ölçü Aletleri (Faz Kalemı Tipi)

DIGI CHECK PRO	0,3 - 690 V AC/DC, LCD ekran, Faz Sırası Göstegesi, buton ile 30mA RCD tetikleme, tek kutup faz testi, ışıklı ölçme problemleri	9918870000	1.710,00 TL	1
MULTI CHECK	5 - 500 V AC/DC, LCD ekran, tek kutup faz testi	9918920000	900,00 TL	1
COMBI CHECK	6 - 690 V AC/DC, LED skala, Faz Sırası Göstegesi, tek kutup faz testi, ışıklı ölçme problemleri	9918860000	745,00 TL	1
MASTER CHECK	6 - 400 V AC/DC, LED skala(6V,12V,24V,50V,120V,230V,400V)	9918880000	674,00 TL	1
Volt-Check 3.1	6 - 400 V AC/DC, LED skala(12V,50V,120V,230V,400V)	9918950000	243,00 TL	1

Test ve Ölçü Aletleri

TEMPHASER	0.2 - 600 VAC/DC, 2,000 MΩ kadar direnç, 20 µF - 20 mF arası kapasite, 10 Hz - 40 kHz arası frekans, diyot ve faz sırası testi	9427300000	1.287,00 TL	1
MULTIMETER 125S	0.32 - 600 VAC/DC, 30 MΩ kadar direnç, Diyot Testi	9425830000	1.014,00 TL	1
MG KIT CA 600	0.2 - 600 V AC/DC, 0 - 600 A AC/DC amp., 2,000 MΩ kadar direnç, 20 µF - 20 mF arası kapasite, 10 Hz - 40 kHz arası frekans, diyot ve faz sırası testi	9427460000	3.043,00 TL	1
MULTIMETER 1037	0.2 - 1,000 V DC, 0.2 - 750 V AC, 200A AC ye kadar pens amp. Adaptörü, 200kΩ a kadar direnç ve 20 µF a kadar kapasite ölçümü	9423580000	2.384,00 TL	1
MULTIMETER C 2606	0.2 - 1,000 V DC, 0.2 - 750 V AC, 1000 A AC/DC ye kadar amp., 40 MΩ kadar direnç, 4 nF - 40 µF kapasite, 0.1 - 400 kHz frekans, diyot testi	9427370000	2.925,00 TL	1
LAN USB TESTER	LAN ve USB bağlantıları için network kablo test aleti, LED skala/RJ45, USB A, USB B bağlantı tipi/ max 1000 mt	9205400000	888,00 TL	1
THERMOMETER 610 LC	-20°C...260°C derece lazer sıcaklık ölçümü	9427520000	2.340,00 TL	1

El Aletleri Seti

CRIMP-SET PZ 6 ROTO L	PZ 6 ROTO, STRIPAX ve 7 Bölme Yüksük	9028680000	3.120,00 TL	1
CRIMP-SET PZ 6/5	PZ 6/5, STRIPAX ve 7 Bölme Yüksük	9028740000	3.509,00 TL	1
CRIMP-SET PZ 16	PZ 16. STRIPAX 16 ve 6 Bölme Yüksük	9025850000	3.509,00 TL	1
Crimpset PZ / CTI	CTI 6, STRIPAX ve 19 Bölme Pabuç	9202610000	6.633,00 TL	1

Serinin devamı sayfa 64



Pro Case Insta

Tip	Açıklama	Sipariş No	Fiyat/Birim	Ambalaj
Crimp-Set Kontakte	25 Bölmeli Yüksük ve Pabuç Kutusu (Yüksük,Pabuç dahil)	9202640000	2.340,00 TL	1
H-LEERBOX 5	5 Bölmeli, Yuvarlak Tip Boş Yüksük Kutusu	9025940000	116,65 TL	1
Tool Set Combi Check	KT 8, Stripax, PZ 6 Roto, Combi Check ve Screwdriverset	9201650000	3.599,00 TL	1
PROFI SET	KT 8, Stripax, Screwdriverset ve SK WSD-S	9918840000	1.918,00 TL	1

Takım Çantaları

Pro Case Insta

Tip	Açıklama	Sipariş No	Fiyat/Birim	Ambalaj
Pro Case Insta	18 Parça Takım Çantası	9203160000	10.724,00 TL	1
AM 25	6...25 mm çap aralığına sahip kabloları soyma	-	-	1
KT 8	16mm ² kesite kadar olan kabloları kesme	-	-	1
STRIPAX	0.08...10mm ² kesit aralığına sahip kablo soyma ve kesme	-	-	1
PZ 6 Roto	0,14...6mm ² kesit aralığında olan kablolar için yüksük sıkma(tek çene)	-	-	1
H-BOX 0,5-2,5QMM DIN	0.5...2.5 mm ² kesit aralığında yüksüklerinde içinde bulunduğu yüksük kutusu	-	-	1
AM 12	0.5...12.5mm çap aralığına sahip kabloları soyma	-	-	1
COMBI CHECK	6-690 V AC/DC,LED skala,Faz Sırası Göstegesi, tek kutup faz testi,ışıklı ölçme problemleri	-	-	1
FLEXIMET 5 M	Weidmüller çelik metre	-	-	1
Pro Case leer	BEZ ÇANTA	-	-	1
STRIPPER ROUND TOP	8...13mm çap aralığında çok damarlı kabloları çift kademeli soyma	-	-	1
FRZ S 160	160 mm / 60 HRC Kargaburun	-	-	1
SE HD 180	Sert kablolar için diogonal kesme pensesi	-	-	1
KBZ 180	180 mm / 60 HRC pense	-	-	1
CROSS-KEY UNIVERSAL	pano anahtarı	-	-	1
SK WSD-S 1,5-10,0	9 parçadan oluşan alyan anahtarı seti	-	-	1
SDI Set S2.5-5.5/PH1/2	6 parçadan oluşan izoleli tornavida seti	-	-	1
SKS 2,0-8,0 MR	7 parçadan oluşan alyan anahtarı	-	-	1
PACK HEXA 8-13	lokma anahtar takımı	-	-	1

Tip	Açıklama	Sipariş No	Fiyat/Birim	Ambalaj
-----	----------	------------	-------------	---------

Tip	Açıklama	Sipariş No	Fiyat/Birim	Ambalaj
Pro Case Premium	25 Parça Takım Çantası	9202460000	17.940,00 TL	1
AM 25	6...25 mm çap aralığına sahip kabloları soyma	-	-	1
KT 8	16mm ² kesite kadar olan kabloları kesme	-	-	1
STRIPAX	0.08...10mm ² kesit aralığına sahip kablo soyma ve kesme	-	-	1
PZ 6 Roto	0,14...6mm ² kesit aralığında olan kablolar için yüksük sıkma(tek çene)	-	-	1
H-BOX 0,5-2,5QMM DIN	0.5...2.5 mm ² kesit aralığında yüksüklerinde içinde bulunduğu yüksük kutusu	-	-	1
AM 12	0.5...12.5mm çap aralığına sahip kabloları soyma	-	-	1
DIGI CHECK	0,3 - 690 V AC/DC, LCD ekran, tek kutup faz testi,ışıklı ölçme problemleri	-	-	1
COMBI CHECK	6-690 V AC/DC,LED skala,Faz Sırası Göstegesi,tek kutup faz testi,ışıklı ölçme problemleri	-	-	1
Pro Case leer	BEZ ÇANTA	-	-	1
STRIPPER ROUND TOP	8...13mm çap aralığında çok damarlı kabloları çift kademeli soyma	-	-	1
FRZ S 160	160 mm / 60 HRC Kargaburun	-	-	1
SE HD 180	Sert kablolar için diogonal kesme pensesi	-	-	1
KBZ 180	180 mm / 60 HRC pense	-	-	1
RZ 160	160 mm / Yuvarlak Uç	-	-	1
AIZ 160	5mm çapa kadar yan keski	-	-	1
CROSS-KEY UNIVERSAL	pano anahtarı	-	-	1
SWIFTY SET	SD 0,6x3,5x100 tornavida ve kesme aparatı	-	-	1
SK WSD-S 1,5-10,0	9 parçadan oluşan alyan anahtarı seti	-	-	1
SD Set S2.5-5.5/PH1/2	6 parçadan oluşan izolesiz tornavida seti	-	-	1
SDI Set S2.5-5.5/PH1/2	6 parçadan oluşan izoleli tornavida seti	-	-	1
Bit-Box WI DMS 3	9 parça tornavida uç seti	-	-	1
SKS 2,0-8,0 MR	7 parçadan oluşan alyan anahtarı	-	-	1
TESTBOY 20	ışıklı kontrol test kalemi	-	-	1
WK S 0,5x3,0	0.5 x 3 boyutunda değiştirilebilir	-	-	1
DMS MANUELL 0,5-1,7	0.5-1.7 Nm Tork ayarlı Tornavida	-	-	1



Pro Case Premium



TOP CASE INSTA

Tip	Açıklama	Sipariş No	Fiyat/Birim	Ambalaj
Top Case Insta				
TOP CASE INSTA	18 Parça Takım Çantası	1345310000	12.870,00 TL	1
AM 25	6...25 mm çap aralığına sahip kabloları soyma	-	-	1
KT 8	16mm ² kesite kadar olan kabloları kesme	-	-	1
STRIPAX	0.08...10mm ² kesit aralığına sahip kablo soyma ve kesme	-	-	1
PZ 6 Roto	0,14...6mm ² kesit aralığında olan kablolar için yüksek sıkma (tek çene)	-	-	1
H-BOX 0,5-2,5QMM DIN	0.5...2.5 mm ² kesit aralığında yükseklerinde içinde bulunduğu yüksek kutusu	-	-	1
AM 12	0.5...12.5mm çap aralığına sahip kabloları soyma	-	-	1
COMBI CHECK	6-690 V AC/DC,LED skala,Faz Sırası Göstegesi,tek kutup faz testi,ışıklı ölçme problemleri	-	-	1
PLASTIC CASE	PLASTİK SERT KAPAK ÇANTA	-	-	1
STRIPPER ROUND TOP	8...13mm çap aralığında çok damarlı kabloları çift kademeli soyma	-	-	1
FRZ S 160	160 mm / 60 HRC Kargaburun	-	-	1
SE HD 180	Sert kablolar için diogonal kesme pensesi	-	-	1
KBZ 180	180 mm / 60 HRC pense	-	-	1
CROSS-KEY UNIVERSAL	pano anahtarı	-	-	1
SK WSD-S 1,5-10,0	9 parçadan oluşan alyan anahtarı seti	-	-	1
SDI Set S2.5-5.5/PH1/2	6 parçadan oluşan izoleli tornavida seti	-	-	1
SKS 2,0-8,0 MR	7 parçadan oluşan alyan anahtarı	-	-	1
Pack HEXA P-13	lokma anahtar takımı	-	-	1
Fleximet M5	Weidmüller çelik metre	-	-	1



TOP CASE PREMIUM

Tip	Açıklama	Sipariş No	Fiyat/Birim	Ambalaj
Top Case Premium				
TOP CASE PREMIUM	24 Parça Takım Çantası	1345320000	18.332,00 TL	1
AM 25	6...25 mm çap aralığına sahip kabloları soyma	-	-	1
KT 8	16mm ² kesite kadar olan kabloları kesme	-	-	1
STRIPAX	0.08...10mm ² kesit aralığına sahip kablo soyma ve kesme	-	-	1
PZ 6 Roto	0,14...6mm ² kesit aralığında olan kablolar için yüksek sıkma (tek çene)	-	-	1
H-BOX 0,5-2,5QMM DIN	0.5...2.5 mm ² kesit aralığında yükseklerinde içinde bulunduğu yüksek kutusu	-	-	1
AM 12	0.5...12.5mm çap aralığına sahip kabloları soyma	-	-	1
DIGI CHECK	0,3-690 V AC/DC, LCD ekran, tek kutup faz testi,ışıklı ölçme problemleri	-	-	1
COMBI CHECK	6-690 V AC/DC,LED skala,Faz Sırası Göstegesi,tek kutup faz testi,ışıklı ölçme problemleri	-	-	1
PLASTIC CASE	PLASTİK SERT KAPAK ÇANTA	-	-	1
STRIPPER ROUND TOP	8...13mm çap aralığında çok damarlı kabloları çift kademeli soyma	-	-	1
FRZ S 160	160 mm / 60 HRC Kargaburun	-	-	1
SE HD 180	Sert kablolar için diogonal kesme pensesi	-	-	1
KBZ 180	180 mm / 60 HRC pense	-	-	1
RZ 160	160 mm / Yuvarlak Uç	-	-	1
CROSS-KEY UNIVERSAL	pano anahtarı	-	-	1
SWIFTY SET	SD 0,6x3,5x100 tornavida ve kesme aparatı	-	-	1
SK WSD-S 1,5-10,0	9 parçadan oluşan alyan anahtarı seti	-	-	1
SD Set S2.5-5.5/PH1/2	6 parçadan oluşan izolesiz tornavida seti	-	-	1
SDI Set S2.5-5.5/PH1/2	6 parçadan oluşan izoleli tornavida seti	-	-	1
Bit-Box WI DMS 3	9 parça tornavida uç seti	-	-	1
SKS 2,0-8,0 MR	7 parçadan oluşan alyan anahtarı	-	-	1
WK S 0,5x3,0	0.5 x 3 boyutunda değiştirilebilir	-	-	1
DMS MANUELL 0,5-1,7	0.5-1.7 Nm Tork ayarlı Tornavida	-	-	1
AM 16	6...17 mm çap aralığına sahip PVC kablolar için	-	-	1



Pro Case leer

Tip	Açıklama	Sipariş No	Fiyat/Birim	Ambalaj
Boş Takım Çantaları				
Pro Case leer	Boş Takım Çantası Bez	9202470000	1.364,00 TL	1
TOP CASE	Boş Takım Çantası Metal Çerçeve	1345330000	3.140,00 TL	1

El Aletleri



CUTFIX 8



CRIMPFIX L

Tip	Açıklama	Sipariş No	Fiyat/Birim	Ambalaj
Otomatik Makinalar				
CUTFIX 8	0,14...10mm ² flexible kablo kesme	9023100000	6.555,00 €	1
POWERSTRIPPER 6,0	0,14-6mm ² güçlü soyma	9028510000	3.795,00 €	1
POWERSTRIPPER 16,0	2,5-16mm ² güçlü soyma	9028480000	5.417,00 €	1
POWERSTRIPPER ao 2,5/20	0,5-2,5mm ² otomatik soyma	9027270000	7.038,00 €	1
POWERSTRIPPER ao 16/20	4-16mm ² otomatik soyma	9027290000	7.521,00 €	1
CRIMPFIX R	Pinomatik soyma ve şerit yüksük sıkma	9028500000	19.680,00 €	1
CRIMPFIX L	0,5-2,5mm ² kablo soyma ve dökme yüksük sıkma, Pinomatik,8 mm yüksük uç uzunluğu, 14mm yüksük uzunluğu için	9028530000	22.305,00 €	1
CRIMPFIX LS	0,5-2,5mm ² kablo soyma ve dökme yüksük sıkma,Pinomatik,6/8/10 mm yüksük uç uzunluğu, 12/14/16 mm yüksük uzunluğu için	9028540000	25.945,00 €	1
CRIMPFIX LZ	Çift girişli dökme yüksük sıkma	9027310000	28.360,00 €	1

Kutular

Weidmüller'in çok geniş bir ürün yelpazesini oluşturan kutular, elektrik bağlantılarını ve komponentlerini çok çeşitli şartlar ve zorlu çevre koşullarından korumak için tasarlandı ve bu şartlarda test edilerek kullanıma sunuldu.

Klippon K Alüminyum Kutular

K serisi alüminyum kutuların birçok uygulama sahası vardır. K serisi kutuların içlerine klemensler, şalterler, butonlar, göstergeler ve elektronik komponentler montaj edilebilir.

Özellikleri:

- 2 tip olarak 19 ayrı ölçü
- Paslanmaz çelik kapak vidaları
- Montaj delikleri kutu içinden izoleli
- Raylar ve diğer montaj plakaları için açılmış vida dişleri
- IP 66, IP 67 ve IP 68 koruma sınıfı
- Yağmur, erimiş kar ve çığ gibi koşullarda kullanılabilir.

Endüstri ve ulaşımda kullanılabilir. Ayrıca ATEX standartlarına uygun olduğundan patlama tehlikesi olan ortamlarda kullanılabilir.

Klippon POK Polyester Kutular

Cam elyafları içeren kuvvetlendirilmiş POK serisi polyester kutular hem iç ortamlarda hem de dış ortamlarda kullanılmaya uygundur.

Özellikleri:

- 2 tip olarak 17 ölçü
- Paslanmaz çelik kapak vidaları
- Montaj delikleri kutu içinden izole
- Raylar ve diğer montaj plakaları için açılmış vida delikleri
- IP 66 Koruma sınıfı

Bu kutular özellikle paslanma ve darbeye karşı, yüksek koruma sınıfı gerektiren uygulamalarda tercih edilirler.





KLIPPON K02



KLIPPON POK 080806



KLIPPON POK 081606



MPC 07/12/07 7035



MPC 12/12/07 7035



FPC 20/20/13 7035

Tip	Boy x En x Derinlik (mm)	Ağırlık	Sipariş No	Fiyat/Birim	Ambalaj
Alüminyum Döküm Gövde- Klippon® K					
KLIPPON K0	45 x 50 x 30	65 g	573200000	8,50 €	10
KLIPPON K1	70 x 70 x 45	220 g	342000000	15,70 €	10
KLIPPON K11	80 x 75 x 57	280 g	573300000	20,95 €	10
KLIPPON K2	70 x 100 x 45	280 g	342100000	24,85 €	10
KLIPPON K21	80 x 125 x 57	400 g	573400000	15,70 €	5
KLIPPON K3	70 x 165 x 45	400 g	342200000	20,95 €	5
KLIPPON K31	80 x 175 x 57	520 g	573500000	24,85 €	5
KLIPPON K4	82 x 130 x 72	620 g	342300000	27,50 €	1
KLIPPON K5	130 x 170 x 90	1540 g	342400000	54,95 €	1
KLIPPON K6	160 x 200 x 100	2000 g	342500000	61,50 €	1
KLIPPON K61	160 x 260 x 91	2060 g	573600000	75,90 €	1
KLIPPON K7	160 x 350 x 100	2870 g	342600000	91,60 €	1
KLIPPON K71	230 x 280 x 111	2925 g	573700000	107,30 €	1
KLIPPON K01	64 x 58 x 34	120 g	1565240000	17,00 €	10
KLIPPON K02	64 x 98 x 34	200 g	1565250000	19,65 €	6
KLIPPON K32	80 x 250 x 55	710 g	1565260000	39,25 €	1
KLIPPON K41	120 x 122 x 81	840 g	1565270000	40,55 €	1
KLIPPON K51	120 x 220 x 81	1280 g	1565280000	51,05 €	1
KLIPPON K52	160 x 160 x 91	1480 g	1565290000	60,20 €	1
Polyester - Klippon® POK					
KLIPPON POK 080806	75 x 80 x 55	230 g	1305810000	27,50 €	1
KLIPPON POK 081106	75 x 110 x 55	295 g	1305820000	28,80 €	1
KLIPPON POK 081606	75 x 160 x 55	405 g	1305830000	32,70 €	1
KLIPPON POK 081906	75 x 190 x 55	450 g	1305840000	37,95 €	1
KLIPPON POK 082306	75 x 230 x 55	575 g	1305850000	40,60 €	1
KLIPPON POK 121209	120 x 122 x 90	750 g	1305870000	43,20 €	1
KLIPPON POK 122209	120 x 220 x 90	1060 g	1305880000	49,70 €	1
KLIPPON POK 161609	160 x 160 x 90	1290 g	1305890000	53,65 €	1
KLIPPON POK 162609	160 x 260 x 90	1710 g	1305900000	75,90 €	1
KLIPPON POK 163609	160 x 360 x 90	2150 g	1305910000	90,30 €	1
KLIPPON POK 165609	160 x 560 x 90	3185 g	1305920000	149,00 €	1
KLIPPON POK 252512	250 x 255 x 120	2650 g	1305930000	116,50 €	1
KLIPPON POK 254012	250 x 400 x 120	3650 g	1305940000	142,50 €	1
KLIPPON POK 256012	250 x 600 x 120	5235 g	1305950000	204,00 €	1
KLIPPON POK 404012	405 x 400 x 120	5580 g	1305970000	173,00 €	1
KLIPPON POK 252516	250 x 255 x 160	3275 g	1305980000	149,00 €	1
KLIPPON POK 254016	250 x 400 x 160	4800 g	1305990000	196,00 €	1
Polikarbonat - Klippon® MPC					
MPC 07/12/07 7035	125 x 75 x 75	209 g	9535170000	17,50 €	1
MPC 07/12/12 7035	125 x 75 x 125	300 g	9535210000	20,00 €	1
MPC 12/12/07 7035	125 x 125 x 75	283 g	9535230000	18,70 €	1
MPC 12/17/07 7035	175 x 125 x 75	381 g	9535290000	23,80 €	1
MPC 12/17/10 7035	175 x 125 x 100	465 g	9535310000	24,85 €	1
MPC 12/17/12 7035	175 x 125 x 125	530 g	9535330000	25,95 €	1
MPC 17/17/07 7035	175 x 175 x 75	461 g	9535370000	30,05 €	1
MPC 17/17/15 7035	175 x 175 x 150	717 g	9535430000	41,10 €	1
MPC 17/25/10 7035	250 x 175 x 100	743 g	9535470000	48,65 €	1
Polikarbonat - Klippon® FPC					
FPC 20/20/13 7035	200 x 200 x 130	1039 g	9535690000	53,55 €	1
FPC 20/30/13 7035	200 x 300 x 130	1349 g	9535710000	69,00 €	1

Serinin devamı sayfa 69



FPC 20/40/13 7035



KTB QL 303020 SE4



KTB MH 221513 S4E1

Tip	Boy x En x Derinlik (mm)	Ağırlık	Sipariş No	Fiyat/Birim	Ambalaj
FPC 20/40/13 7035	200 x 400 x 130	1674 g	9535730000	93,00 €	1
FPC 30/30/13 7035	300 x 300 x 130	1738 g	9535750000	95,15 €	1
FPC 30/40/13 7035	300 x 400 x 130	2199 g	9535770000	112,50 €	1
FPC 40/60/13 7035	400 x 600 x 130	3964 g	9535810000	215,00 €	1

	Klippon TB MH	Klippon TB QL	Klippon STB
--	---------------	---------------	-------------

Paslanmaz Çelik - Yeni Seri

Malzeme	Paslanmaz Çelik	Paslanmaz Çelik	Paslanmaz Çelik
Malzeme Özellikleri	"Paslanmaz Çelik 1.4404 (316L) 1.5 mm"	"Paslanmaz Çelik 1.4404 (316L) 1.5 mm"	"Paslanmaz Çelik 1.4404 (316L) 1.6 mm"
Su Dayanımı	çok iyi	çok iyi	çok iyi
UV Dayanımı	çok iyi	çok iyi	çok iyi
Halojen Free	x	x	x

Yüzey	Elektroliz yolu ile parlatılmış	Elektroliz yolu ile parlatılmış	"Elektroliz yolu ile parlatılmış Ayna parlaklığı"
-------	---------------------------------	---------------------------------	--

Kullanım Amacı	Patlayıcı ortamlar, off-shore, yağ ve gaz endüstrisi, kimya endüstrisi, proses endüstrisi	Patlayıcı ortamlar, off-shore, yağ ve gaz endüstrisi, kimya endüstrisi, proses endüstrisi	
----------------	---	---	--

Boyutlar

LXWXH (min) mm	229x152x133	229x152x133	120x120x80
LXWXH (max) mm	987x740x200	987x740x200	250x400x130

Geometri	3 adet standart derinlik	3 adet standart derinlik	5 adet standart derinlik
----------	--------------------------	--------------------------	--------------------------

Özel Karakteristikler

Sıcaklık Aralığı	-60 °C...+135 °C	-60 °C...135 °C	EX Tipi	Endüstriyel Tipi
------------------	------------------	-----------------	---------	------------------

Darbe Dayanımı	"10 Jendüstri Uygulamaları 7 J ATEX Uygulamalar"	"10 Jendüstri Uygulamaları 7 J ATEX Uygulamalar"	7J	10J
----------------	---	---	----	-----

IP Koruma Sınıfı				
------------------	--	--	--	--

Uygunluk

ATEX	x	x	x
------	---	---	---

- EN60079-7 Increased safety	x	x	x
------------------------------	---	---	---

- EN60079-11 Intrinsic safety	x	x	x
-------------------------------	---	---	---

IECEX	x	x	
-------	---	---	--

- IEC60079-7 Increased safety	x	x	
-------------------------------	---	---	--

- IEC60079-11 Intrinsic safety	x	x	
--------------------------------	---	---	--

GOST Ex	x	x	
---------	---	---	--

GOST	*	*	
------	---	---	--

cULus	x	x	x	*
-------	---	---	---	---

UL				
----	--	--	--	--

German Lloyd	x	x	x	
--------------	---	---	---	--

Lloyds Register			x	*
-----------------	--	--	---	---

Russian Maritime Register	x	x		
---------------------------	---	---	--	--

CCOE	*			
------	---	--	--	--

Tip

Paslanmaz Çelik - Yeni Seri

Paslanmaz Çelik - Klippon® TB MH - Multi Hinge

Tip	Boy x En x Derinlik (mm)	Koruma Sınıfı	Sipariş No	Fiyat/Birim	Ambalaj
KTB MH 221513 S4E1	229 x 152 x 133	IP66, IP67	1194560000	484,00 €	1
KTB MH 262615 S4E1	260 x 260 x 150	IP66, IP67	1194610000	571,00 €	1
KTB MH 262620 S4E1	260 x 260 x 200	IP66, IP67	1194660000	633,00 €	1
KTB MH 303015 S4E1	306 x 306 x 150	IP66, IP67	1194710000	610,00 €	1
KTB MH 303020 S4E1	306 x 306 x 200	IP66, IP67	1194760000	670,00 €	1
KTB MH 352615 S4E1	350 x 260 x 150	IP66, IP67	1194810000	618,00 €	1

Serinin devamı sayfa 70



KTB QL 221513 S4E1



KTB QL 262620 S4E1



KLIPPON STB 2 SS



KLIPPON STB 1 SS

Tip	Boy x En x Derinlik (mm)	Koruma Sınıfı	Sipariş No	Fiyat/Birim	Ambalaj
KTB MH 352620 S4E1	350 x 260 x 200	IP66, IP67	1194860000	695,00 €	1
KTB MH 403015 S4E1	400 x 300 x 150	IP66, IP67	1194910000	674,00 €	1
KTB MH 403020 S4E1	400 x 300 x 200	IP66, IP67	1194960000	764,00 €	1
KTB MH 453815 S4E1	458 x 382 x 150	IP66, IP67	1195010000	793,00 €	1
KTB MH 453820 S4E1	458 x 382 x 200	IP66, IP67	1195060000	850,00 €	1
KTB MH 484815 S4E1	480 x 480 x 150	IP66, IP67	1195110000	916,00 €	1
KTB MH 484820 S4E1	480 x 480 x 200	IP66, IP67	1195160000	1.064,00 €	1
KTB MH 553515 S4E1	550 x 350 x 150	IP66, IP67	1195210000	982,00 €	1
KTB MH 553520 S4E1	550 x 350 x 200	IP66, IP67	1195260000	982,00 €	1
KTB MH 624515 S4E1	620 x 450 x 150	IP66, IP67	1195310000	1.204,00 €	1
KTB MH 624520 S4E1	620 x 450 x 200	IP66, IP67	1195360000	1.282,00 €	1
KTB MH 765015 S4E1	762 x 568 x 150	IP66, IP67	1195410000	1.380,00 €	1
KTB MH 765020 S4E1	762 x 568 x 200	IP66, IP67	1195460000	1.619,00 €	1
KTB MH 916115 S4E1	914 x 610 x 150	IP66, IP67	1195510000	1.877,00 €	1
KTB MH 916120 S4E1	914 x 610 x 200	IP66, IP67	1195560000	1.914,00 €	1
KTB MH 987420 S4E1	980 x 740 x 200	IP66, IP67	1195610000	2.108,00 €	1

Paslanmaz Çelik - Klippon® TB QL - Quarter Lock

KTB QL 221513 S4E1	229 x 152 x 133	IP66	1199860000	448,50 €	1
KTB QL 262615 S4E1	260 x 260 x 150	IP66	1199910000	617,00 €	1
KTB QL 262620 S4E1	260 x 260 x 200	IP66	1199960000	657,00 €	1
KTB QL 303015 S4E1	306 x 306 x 150	IP66	1200020000	640,00 €	1
KTB QL 303020 S4E1	306 x 306 x 200	IP66	1200070000	684,00 €	1
KTB QL 352615 S4E1	350 x 260 x 150	IP66	1200120000	715,00 €	1
KTB QL 352620 S4E1	350 x 260 x 200	IP66	1200170000	755,00 €	1
KTB QL 403015 S4E1	400 x 300 x 150	IP66	1200230000	804,00 €	1
KTB QL 403020 S4E1	400 x 300 x 200	IP66	1200280000	846,00 €	1
KTB QL 453815 S4E1	458 x 382 x 150	IP66	1200340000	813,00 €	1
KTB QL 453820 S4E1	458 x 382 x 200	IP66	1200390000	850,00 €	1
KTB QL 484815 S4E1	480 x 480 x 150	IP66	1200450000	930,00 €	1
KTB QL 484820 S4E1	480 x 480 x 200	IP66	1200510000	1.064,00 €	1
KTB QL 553515 S4E1	550 x 350 x 150	IP66	1200560000	1.076,00 €	1
KTB QL 553520 S4E1	550 x 350 x 200	IP66	1200620000	1.076,00 €	1
KTB QL 624515 S4E1	620 x 450 x 150	IP66	1200670000	1.225,00 €	1
KTB QL 624520 S4E1	620 x 450 x 200	IP66	1200730000	1.281,00 €	1
KTB QL 765015 S4E1	762 x 568 x 150	IP66	1200780000	1.380,00 €	1
KTB QL 765020 S4E1	762 x 568 x 200	IP66	1200840000	1.619,00 €	1
KTB QL 916115 S4E1	914 x 610 x 150	IP66	1200890000	1.878,00 €	1
KTB QL 916120 S4E1	914 x 610 x 200	IP66	1200950000	1.915,00 €	1
KTB QL 987420 S4E1	980 x 740 x 200	IP66	1201010000	2.108,00 €	1

Paslanmaz Çelik - Klippon® STB

KLIPPON STB 1 SS	120 x 120 x 80	IP66	1002690000	180,00 €	1
KLIPPON STB 1.1 SS	150 x 120 x 80	IP66	1002750000	189,00 €	1
KLIPPON STB 2 SS	150 x 150 x 90	IP66	1002740000	197,00 €	1
KLIPPON STB 2.1 SS	190 x 150 x 90	IP66	1002730000	247,00 €	1
KLIPPON STB 3 SS	190 x 190 x 100	IP66	1002720000	258,50 €	1
KLIPPON STB 4 SS	250 x 250 x 120	IP66	1002710000	325,50 €	1
KLIPPON STB 5 SS	160 x 380 x 120	IP66	1002700000	404,50 €	1
KLIPPON STB 6 SS	250 x 400 x 130	IP66	1002760000	479,00 €	1

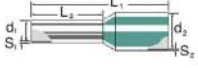

H1,0/14 GE



H0,5/6

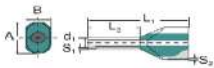

H0,5/14 ZH OR

Tip	Renk	Sipariş No	Fiyat/Birim	Ambalaj
Kablo Bağlantı Yüksükleri				
İzoleli İletken Yüksükleri				
H0,5/14 OR	Turuncu	690700000	0,097 TL	500
H0,75/14 W	Beyaz	462900000	0,097 TL	500
H1,0/14 GE	Sarı	463000000	0,097 TL	500
H1,5/14 R	Kırmızı	463100000	0,097 TL	500
H1,5/16 R	Kırmızı	635100000	0,167 TL	500
H1,5/24 R	Kırmızı	565600000	0,236 TL	500
H6,0/20 SW	Siyah	533500000	0,308 TL	100
H6,0/26 SW	Siyah	565700000	0,428 TL	100
H10,0/22 EB	Fildişi	534200000	0,410 TL	100
H10,0/28 EB	Fildişi	565800000	0,559 TL	100
H16,0/22 GN	Yeşil	565900000	0,521 TL	100
H16,0/28 GN	Yeşil	566000000	0,717 TL	100
H25,0/30 BR	Kahverengi	317000000	1,12 TL	50
H25,0/36 BR	Kahverengi	317100000	1,42 TL	50
H35,0/30 BE	Bej	317200000	1,49 TL	50
H35,0/39 BE	Bej	317300000	1,89 TL	50
H50/36 OLIV	Zeytin Yeşil	444200000	2,35 TL	50
H2,5/14S BL	Mavi	1333100000	0,138 TL	500
H2,5/19D BL	Mavi	9019170000	0,224 TL	500
H2,5/25D BL	Mavi	9019180000	0,354 TL	500
H4,0/18D GR	Gri	9019190000	0,224 TL	500
H4,0/20D GR	Gri	9019200000	0,308 TL	500
H4,0/26D GR	Gri	9019210000	0,373 TL	100
Kablo Bağlantı Yüksükleri				
İzolesiz İletken Yüksükleri				
H0,5/6	0.5 mm ² / 6 mm	282600000	0,072 TL	1000
H0,75/10	0.75 mm ² / 10mm	542500000	0,084 TL	1000
H1,0/10	1 mm ² / 10mm	282800000	0,120 TL	1000
H1,5/10	1.5 mm ² / 10	186500000	0,130 TL	1000
H2,5/12	2.5 mm ² / 12mm	186100000	0,140 TL	1000
H4,0/12	4 mm ² / 12mm	244100000	0,170 TL	1000
H6,0/12	6 mm ² / 12mm	191900000	0,210 TL	500
H10,0/12	10 mm ² / 12mm	282900000	0,250 TL	500
H16,0/12	16mm ² / 12mm	492500000	0,370 TL	500
Kablo Bağlantı Yüksükleri				
Çift Girişli İzoleli İletken Yüksükleri				
H0,5/14 ZH OR	Turuncu	9037200000	0,270 TL	500
H0,75/14 ZH W	Beyaz	9037230000	0,284 TL	500
H1,0/15 ZH GE	Sarı	9037260000	0,284 TL	500
H1,5/16 ZH R	Kırmızı	9037290000	0,284 TL	500
H2,5/19D ZH BL	Mavi	9037500000	0,335 TL	500
H4,0/22D ZH GR	Gri	9037530000	0,838 TL	100
H6,0/23 ZH SW	Siyah	9037320000	1,02 TL	100
H10,0/24 ZH EB	Fildişi	9037340000	1,27 TL	100
H16,0/29 ZH GN	Yeşil	9037360000	1,55 TL	50

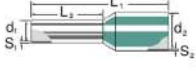

HO,5/14 OR BD

Tip	Renk	Sipariş No	Fiyat/Birim	Ambalaj
İzoleli Şerit Yüksükler (Stripax Plus için)				
HO,5/14 OR BD	Turuncu	9004270000	0,158 TL	500
HO,75/14 W BD	Beyaz	9004290000	0,158 TL	500
H1,0/14 GE BD	Sarı	9004320000	0,158 TL	500
H1,5/14 R BD	Kırmızı	9004340000	0,158 TL	500
H2,5/14D BL BD	Mavi	9004360000	0,215 TL	500
İzoleli Makara Şerit Yüksükler (Otomatik Makinalar için)				
HO,5/14 OR BD GSP	Turuncu	9005810000	0,217 TL	5000
HO,75/14 W BD GSP	Beyaz	9005820000	0,217 TL	5000
H1,0/14 GE BD GSP	Yeşil	9005830000	0,217 TL	5000
H1,5/14 R BD GSP	Kırmızı	9005840000	0,217 TL	5000
H2,5/14D BL BD GSP	Mavi	9005850000	0,242 TL	3000
HO,5/14D W BD GSP	Beyaz	9005860000	0,217 TL	5000
HO,75/14D GR	gri	9005870000	0,217 TL	5000
H1,0/14D R BD GSP	Kırmızı	9005880000	0,217 TL	5000
H1,5/14D SW BD GSP	Siyah	9005890000	0,217 TL	5000
HO,75/14T BL BD GSP	Mavi	9005900000	0,217 TL	5000
H2,5/14T GR BD GSP	Gri	9005910000	0,242 TL	3000



LIR 1,5M3 V

Tip	Ölçü	Sipariş No	Fiyat/Birim	Ambalaj
İzoleli Kablo Pabuçları				
Yuvarlak Uçlu Kablo Pabuçları				
LIR 1,5M3 V	0.5 - 1.5 mm ²	9200070000	0,428 TL	100
LIR 1,5M3,5 V	0.5 - 1.5 mm ²	9200080000	0,428 TL	100
LIR 1,5M4 V	0.5 - 1.5 mm ²	9200090000	0,540 TL	100
LIR 1,5M5 V	0.5 - 1.5 mm ²	9200100000	0,521 TL	100
LIR 1,5M6 V	0.5 - 1.5 mm ²	9200110000	0,783 TL	100
LIR 2,5M3 V	1.5 - 2.5 mm ²	9200150000	0,521 TL	100
LIR 2,5M4 V	1.5 - 2.5 mm ²	9200170000	0,662 TL	100
LIR 2,5M5 V	1.5 - 2.5 mm ²	9200180000	0,662 TL	100
LIR 2,5M6 V	1.5 - 2.5 mm ²	9200190000	0,876 TL	100
LIR 2,5M8 V	1.5 - 2.5 mm ²	9200200000	0,819 TL	100
LIR 6M4 V	4.0 - 6.0 mm ²	9200230000	1,17 TL	100
LIR 6M5 V	4.0 - 6.0 mm ²	9200240000	1,16 TL	100
LIR 6M6 V	4.0 - 6.0 mm ²	9200250000	1,34 TL	100
LIR 6M8 V	4.0 - 6.0 mm ²	9200260000	1,62 TL	100
Çatal Uçlu Kablo Pabuçları				
LIS 1,5M3 V	0.5 - 1.5 mm ²	9200290000	0,485 TL	100
LIS 1,5M3,5 V	0.5 - 1.5 mm ²	9200300000	0,513 TL	100
LIS 1,5M4 V	0.5 - 1.5 mm ²	9200310000	0,521 TL	100
LIS 1,5M5 V	0.5 - 1.5 mm ²	9200320000	0,559 TL	100
LIS 1,5M6 V	0.5 - 1.5 mm ²	9200330000	0,838 TL	100
LIS 2,5M3,5 V	1.5 - 2.5 mm ²	9200360000	0,606 TL	100
LIS 2,5M4 V	1.5 - 2.5 mm ²	9200370000	0,606 TL	100
LIS 2,5M5 V	1.5 - 2.5 mm ²	9200380000	0,614 TL	100
LIS 2,5M6 V	1.5 - 2.5 mm ²	9200390000	0,876 TL	100
LIS 6M4 V	4.0 - 6.0 mm ²	9200410000	1,06 TL	100
LIS 6M5 V	4.0 - 6.0 mm ²	9200420000	1,08 TL	100
LIS 6M6 V	4.0 - 6.0 mm ²	9200430000	1,42 TL	100
LIS 6M8 V	4.0 - 6.0 mm ²	9200440000	1,89 TL	100



LIS 1,5M3 V



LIP 1,5R12 V



LIF 1,5F638 R



LIB 1,5B25 VF

Tip	Ölçü	Sipariş No	Fiyat/Birim	Ambalaj
İğne Uçlu Kablo Pabuçları				
LIP 1,5R12 V	0.5 - 1.5 mm ²	9200460000	0,606 TL	100
LIP 2,5R12 V	1.5 - 2.5 mm ²	9200470000	0,745 TL	100
LIP 6R14 V	4.0 - 6.0 mm ²	9200480000	1,42 TL	100
Faston Kablo Pabuçları				
LIF 1,5F638 R	0.5 - 1.5 mm ²	9200540000	0,652 TL	100
LIF 2,5F638 R	1.5 - 2.5 mm ²	9200560000	0,707 TL	100
LIF 6F638 R	4.0 - 6.0 mm ²	9200570000	0,987 TL	100
LIF 1,5M638 R	0.5 - 1.5 mm ²	9200580000	0,606 TL	100
LIF 2,5M638 R	1.5 - 2.5 mm ²	9200590000	0,671 TL	100
LIF 6M638 R	4.0 - 6.0 mm ²	9200600000	0,932 TL	100
LIF 1,5F638 RF	0.5 - 1.5 mm ²	9200640000	0,707 TL	100
LIF 2,5F638 RF	1.5 - 2.5 mm ²	9200650000	0,764 TL	100
LIF 6F638 RF	4.0 - 6.0 mm ²	9200660000	1,19 TL	100
Tip		Sipariş No	Fiyat/Birim	Ambalaj
İzoleli Kablo Pabuçları				
Ek Muf				
LIB 1,5B25 VF		9200490000	0,614 TL	100
LIB 2,5B25 VF		9200500000	0,726 TL	100
LIB 6B26 VF		9200510000	1,17 TL	100

Yüksükler ve Pabuçlar

Tip		AWG	Renk kodları/sipariş no:			Manuel Aletler					Soyma ve Sıkma makinaları	
mm ²	L2	AWG	Weidmüller	DIN	Çeşitli	Weidmüller	PZ 6 Roto / PZ 6 Roto L	PZ 6/5	PZ 3	PZ 16	CA 100 serisi	CRIMPRIX serisi
0.25	6	24	9025740000		9021010000							
0.25	8	24	9025760000		9021020000							
0.34	6	22	9025750000									
0.34	8	22	9025770000									
0.50	6	20	0409500000	9019000000								
0.50	8	20	0690700000	9019010000								
0.50	10	20	9025870000	9019020000								
0.75	6	18	0409600000	9019020000	9021030000							
0.75	8	18	0462900000	9019040000	9021040000							
0.75	10	18	9025860000	9019050000	9021050000							
0.75	12	18	9025910000	9019060000	9021060000							
1.00	6	18	0409700000	9019070000								
1.00	8	18	0463000000	9019080000								
1.00	10	18	9025950000	9019100000								
1.00	12	18	9025930000	9019110000								
1.5	6	16	9025960000									
1.5	8	16	0463100000	9019120000								
1.5	10	16	0635100000	9019130000								
1.5	12	16		9019140000								
1.5	18	16	0565600000	9019150000								
2.5	6	14		9028490000	9036200000							
2.5	8	14		9019160000	9021070000							
2.5	10	14		9036220000	9036210000							
2.5	12	14		9019170000	9021080000							
2.5	18	14		9019180000	9021090000							
4	8	12		9028520000	9036230000							
4	10	12		9019190000	9021100000							
4	12	12		9019200000	9021110000							
4	18	12		9019210000	9021120000							
6	12	10	0533500000	9019220000	9021130000							
6	18	10	0565700000	9019230000	9021140000							
10	12	8	0534200000	9019240000	9021150000							
10	18	8	0565800000	9019250000	9021160000							
16	12	6	0565900000	9019260000	9021170000							
16	18	6	0566000000	9019270000	9021180000							



CD 80x60 4/6

Tip	Yükseklik x Genişlik	Sipariş No	Fiyat/Birim	Ambalaj
Kablo Kanalları				
* CD 30x25 4/6	30X25 cm	2589110000	17,45 TL	80M
* CD 40x25 4/6	40X25 cm	2589130000	20,10 TL	60M
* CD 60x25 4/6	60X25 cm	2589150000	29,00 TL	40M
* CD 80x25 4/6	80X25 cm	2589180000	42,05 TL	32M
* CD 40x40 4/6	40X40 cm	2589210000	26,55 TL	40M
* CD 60x40 4/6	60X40 cm	2589230000	35,00 TL	36M
* CD 80x40 4/6	80X40 cm	2589240000	47,80 TL	24M
* CD 100x40 4/6	100X40 cm	2589260000	60,00 TL	16M
* CD 40x60 4/6	40X60 cm	2589280000	33,70 TL	24M
* CD 60x60 4/6	60X60 cm	2589300000	42,00 TL	24M
* CD 80x60 4/6	80X60 cm	2589310000	52,60 TL	24M
* CD 100x60 4/6	100X60 cm	2589330000	80,00 TL	16M
* CD 60x80 4/6	60X80 cm	2589370000	51,00 TL	24M
* CD 80x80 4/6	80X80 cm	2589380000	66,00 TL	24M
* CD 100x80 4/6	100X80 cm	2589400000	86,90 TL	16M
* CD 60x100 4/6	60X100 cm	2589420000	64,00 TL	20M
* CD 80x100 4/6	80X100 cm	2589440000	79,80 TL	16M
* CD 100x100 4/6	100X100 cm	2589450000	144,90 TL	16M
* CD 60x120 4/6	60X120 cm	2589470000	95,60 TL	16M
* CD-BO 80X120 4/6 GY	80X120 cm	2589490000	103,00 TL	16M
* CD-LID 25	25 cm - Kapak	2590110000	12,00 TL	2M
* CD-LID 40	40 cm - Kapak	2590080000	21,00 TL	2M
* CD-LID 60	60 cm - Kapak	2590050000	41,00 TL	2M
* CD-LID 80	80 cm - Kapak	2590020000	48,00 TL	2M
* CD-LID 100	100 cm - Kapak	2590000000	55,00 TL	2M
* CD-LID 120	120 cm - Kapak	2589990000	68,00 TL	2M
* CD 100x40 8/12	100X40 cm	2588630000	69,95 TL	16M
* CD 100X60 8/12 GY	100X60 cm	2588720000	85,60 TL	16M
* CD-BO 100X80 8/12 GY	100X80 cm	2588790000	99,90 TL	16M
* CD 100x100 8/12	100X100 cm	2588850000	138,75 TL	16M
* CD 40x25 8/12	40X25 cm	2588460000	25,85 TL	60M
* CD 40x40 8/12	40X40 cm	2588580000	32,85 TL	40M
* CD 80x80 8/12	80X80 cm	2588770000	91,55 TL	24M

Not: Halojen-free kablo kanallarımız mevcuttur, detaylı bilgi için bölge satış temsilcimizle iletişime geçebilirsiniz.

Tip	Sipariş No	Fiyat/Birim	Ambalaj
Spiral Hortumlar			
FLEX. D8	7730000459	5,80 TL	30
FLEX. D10	7730000015	6,10 TL	30
FLEX. D12	7730000016	6,80 TL	30
FLEX. D14	7730000017	7,95 TL	30
FLEX. D16	7730000018	8,35 TL	30
FLEX. D20	7730000019	10,05 TL	30
FLEX. D22	7730000020	11,20 TL	30
FLEX. D25	7730000409	12,10 TL	30
FLEX. D28	7730000021	17,75 TL	30
FLEX. D32	7730000022	19,50 TL	30
FLEX. D35	7730000023	22,35 TL	30
FLEX. D40	7730000460	27,05 TL	30
FLEX. D50	7730000025	39,15 TL	30
FLEX. D60	7730000461	42,85 TL	30

Kablo Kanalları - Spiral Hortum ve Rakorlar



RACCORDO 50

Tip	Sipariş No	Fiyat/Birim	Ambalaj
Rakorlar			
RACCORDO 10 1/2	7730000026	6,95 TL	50
RACCORDO 12-3/8	7730000027	6,95 TL	50
RACCORDO 14-1/2	7730000028	8,10 TL	50
RACCORDO 16-1/2	7730000029	8,35 TL	50
RACCORDO 20	7730000031	9,80 TL	50
RACCORDO 22-3/4	7730000032	10,25 TL	50
RACCORDO 28-1	7730000033	14,05 TL	25
RACCORDO 32	7730000489	14,05 TL	25
RACCORDO 35	7730000035	17,75 TL	20
RACCORDO 40-1/2	7730000481	23,75 TL	15
RACCORDO 50	7730000037	34,90 TL	10



CB 98/2.5 NATUR

Tip	Renk	Sipariş No	Fiyat/Birim	Ambalaj
Kablo Bağları				
CB 98/2.5 NATUR	Beyaz	7940006690	0,045 TL	1000
CB 98/2.5 BLACK	Siyah	7940007051	0,045 TL	1000
CB 135/2.5 NATUR	Beyaz	7940006040	0,960 TL	100
CB 135/2.5 BLACK	Siyah	7940006047	0,960 TL	100
CB 200/2.6 NATUR	Beyaz	7940006050	0,109 TL	100
CB 200/2.6 BLACK	Siyah	7940006051	0,109 TL	100
CB 140/3.5 NATUR	Beyaz	1278700000	0,118 TL	100
CB 140/3.5 BLACK	Siyah	1697900000	0,128 TL	100
CB 200/3.5 NATUR	Beyaz	1720630000	0,154 TL	100
CB 200/3.5 BLACK	Siyah	1720660000	0,154 TL	100
CB 290/3.5 NATUR	Beyaz	1720640000	0,224 TL	100
CB 290/3.5 BLACK	Siyah	1720650000	0,224 TL	100
CB 370/3.5 NATUR	Beyaz	7940006056	0,549 TL	100
CB 370/3.5 BLACK	Siyah	7940006057	0,549 TL	100
CB 200/4.8 NATUR	Beyaz	1278800000	0,199 TL	100
CB 200/4.8 BLACK	Siyah	1697910000	0,199 TL	100
CB 160/4.5 NATUR	Beyaz	1723540000	0,229 TL	100
CB 160/4.5 BLACK	Siyah	1723560000	0,229 TL	100
CB 178/4.8 NATUR	Beyaz	1723550000	0,231 TL	100
CB 178/4.8 BLACK	Siyah	1723570000	0,231 TL	100
CB 290/4.5 NATUR	Beyaz	1278900000	0,318 TL	100
CB 290/4.5 BLACK	Siyah	1697920000	0,318 TL	100
CB 360/4.5 NATUR	Beyaz	1279000000	0,389 TL	100
CB 360/4.5 BLACK	Siyah	1697930000	0,389 TL	100
CB 180/7.8 NATUR	Beyaz	7940006064	0,465 TL	100
CB 180/7.8 BLACK	Siyah	7940006065	0,465 TL	100
CB 300/7.8 NATUR	Beyaz	7940006068	0,645 TL	100
CB 300/7.8 BLACK	Siyah	7940006069	0,645 TL	100
CB 365/7.5 NATUR	Beyaz	1279100000	0,849 TL	100
CB 365/7.5 BLACK	Siyah	1697940000	0,849 TL	100
CB 450/7.5 NATUR	Beyaz	7940006070	1,19 TL	100
CB 450/7.5 BLACK	Siyah	7940006071	1,19 TL	100
CB 540/7.5 NATUR	Beyaz	7940006072	1,35 TL	100
CB 540/7.5 BLACK	Siyah	7940006073	1,35 TL	100
CB 750/7.5 NATUR	Beyaz	1720680000	1,96 TL	100
CB 750/7.5 BLACK	Siyah	1720670000	1,96 TL	100
CB 780/9.0 NATUR	Beyaz	7940006074	4,00 TL	100
CB 780/9.0 BLACK	Siyah	7940006075	4,00 TL	100
CBH 19/19 NATUR	Kablo Bağı Taşıyıcı	1289200000	0,450 TL	100
CBH 27/27 NATUR	Kablo Bağı Taşıyıcı	1289400000	0,645 TL	100



SCT 4,6/127 C

Tip	Sipariş No	Fiyat/Birim	Ambalaj
Paslanmaz Çelik Kablo Bağları			
SCT 4,6/127 C	1699800000	0,95 €	100
SCT 4,6/201 C	1699810000	1,00 €	100
SCT 4,6/266C	1699900000	1,15 €	100
SCT 4,6/360 C	1699910000	1,20 €	100
SCT 4,6/520	1699920000	1,55 €	100
SCT 4,6/679	1699930000	2,25 €	100
SCT 4,6/838	1699940000	2,50 €	100

Kablo Baęları



SCT-C 4.6/100

Tip	Sipariř No	Fiyat/Birim	Ambalaj
Yüzeyi Tam Kaplamalı İzoleli Paslanmaz Çelik Kablo Baęları			
SCT-C 4.6/100	1015220000	0,95 €	100
SCT-C 4.6/125	1015230000	1,05 €	100
SCT-C 4.6/150	1015240000	1,05 €	100
SCT-C 4.6/200	1015250000	1,30 €	100
SCT-C 4.6/360	1015270000	1,45 €	100
SCT-C 4.6/520	1015280000	1,65 €	100
SCT-C 4.6/680	1015290000	2,10 €	100
SCT-C 4.6/840	1015300000	2,40 €	100
SCT-C 7.9/200	1015310000	1,40 €	100
SCT-C 7.9/360	1015320000	1,60 €	100
SCT-C 7.9/520	1015330000	2,00 €	100
SCT-C 7.9/680	1015340000	2,45 €	100
SCT-C 7.9/840	1015350000	2,80 €	100

Sadeleştirilmiş Yüksek Performans

IP 20 ve IP67 ortamları için geliştirilmiş en akılcı remote I/O çözümü u-remote

“Weidmüller u-remote I/O sistemi, hızlı ve pratik kurulumun yanında sistemin güvenli şekilde başlatılması ve arızası sebepli duruşların minimize edilmesi açısından uygulamalara yönelik tam uyumlu çözümler sunmaktadır.

İnce modül dizaynı ve modül beslemelerinde daha az güç kaynağı ihtiyacı duyan teknolojisi ile pano içinde az yer kaplayarak pano tasarımlarını küçültür. Aynı zamanda el aleti gerekmeksizin kurulum imkanı sunan pratik modül yapısına, web server üzerinden ulaşarak sistem kontrolü, kurulum ve force özelliği ile sistemin test edilerek güvenli başlatılması konusunda kullanıcıya avantajlar sunmaktadır. Modüller üzerinde ve kanal girişlerinde bulunan durum göstergesi LED’leri ile hata tespitini kolaylaştırarak servis sürelerini kısaltmaktadır. IP 20 standartına göre dizayn edilmiş olan u-remote, sistem verimliliğini ve performansını arttırmaktadır.”

Weidmüller u-remote ürün ailesini IP 67 koruma sınıfına sahip modülleri ile genişleterek uygulamaların ihtiyaç duyduğu pratik ve akılcı çözümleri kullanıcıları ile buluşturmaktadır. Çeşitli bus protokollerini destekleyebilen akıllı modülleri ile IP 67 remote I/O modülleri interface kartlar yardımı ile IP 20 I/O grupları ile aynı sistem içerisinde pratik bir şekilde kullanılabilir. IP67 sınıfı esnek ürün portföyü IO-Link bağlantı opsiyonunu bünyesinde barındırmaktadır. Multi protocol özelliğini barındıran akıllı modülleri ile birlikte uygulamalar için daha az maliyetli, daha yüksek performanslı ve devreye alması kolay bir yapı halini alır.

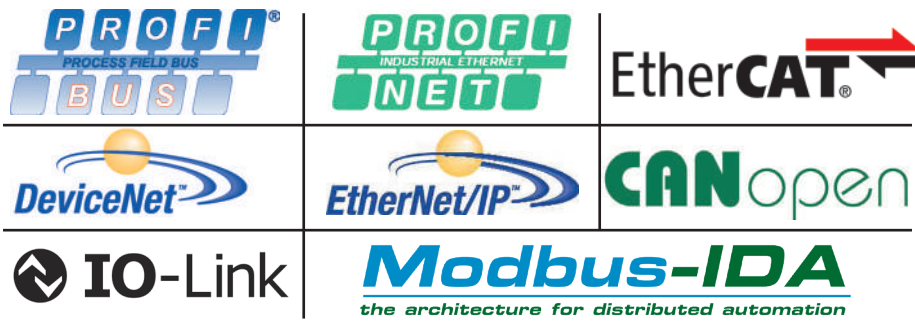

U-Remote I/O Modülleri



UR20-FBC-PB-DP



UR20-FBC-EC



UR20-4DI-2W-230V-AC



UR20-4DI-P-3W



UR20-2DI-P-TS



UR20-4DO-P-2A



UR20-4RO-SSR-255

Tip	Açıklama	Sipariş No	Fiyat/Birim	Ambalaj
Coupler Modülleri				
UR20-FBC-PB-DP	Profibus DP V1 Coupler	1334870000	335,00 €	1
UR20-FBC-PN-IRT	Profinet RT & IRT Coupler	1334880000	390,00 €	1
UR20-FBC-EC	EtherCAT Coupler	1334910000	358,00 €	1
UR20-FBC-MOD-TCP	Modbus TCP Coupler	1334930000	390,00 €	1
UR20-FBC-CAN	CANopen Coupler	1334890000	397,00 €	1
UR20-FBC-EIP	Ethernet/IP Coupler	1334920000	390,00 €	1
UR20-FBC-MOD-TCP-V2	Modbus TCP V2 Coupler (2 CPU ile senkronize ayrı network hatları üzerinden haberleşme)	2476450000	420,00 €	1
UR20-FBC-PL	Powerlink Coupler	1334940000	380,00 €	1
UR20-FBC-DN	DeviceNet Coupler	1334900000	397,00 €	1

Dijital Input Modülleri				
UR20-4DI-2W-230V-AC	4 DI Modülü 230V AC	1550070000	66,00 €	1
UR20-4DI-P	4 DI Modülü (2, 3, 3 + Toprak kablolü)	1315170000	43,00 €	1
UR20-4DI-P-3W	4 DI Modülü (2, 3 kablolü)	2009360000	42,50 €	1
UR20-4DI-N	4 DI Modülü Negatif Anahtarlama	1315350000	56,00 €	1
UR20-8DI-P-2W	8 DI Modülü (2 kablolü)	1315180000	65,00 €	1
UR20-8DI-P-3W	8 DI Modülü (2 ve 3 kablolü)	1394400000	65,00 €	1
UR20-8DI-N-3W	8 DI Modülü (2 ve 3 kablolü) Negatif Anahtarlama	1315370000	80,00 €	1
UR20-16DI-P	16 DI Modülü (1 kablolü)	1315200000	95,00 €	1
UR20-16DI-N	16 DI Modülü Negatif Anahtarlama	1315390000	107,00 €	1
UR20-16DI-P-PLC-INT	16 DI Modülü (PLC Interface)	1315210000	113,50 €	1
UR20-16DI-N-PLC-INT	16 DI Modülü (PLC Interface) Negatif Anahtarlama	1315400000	114,00 €	1
UR20-8DI-P-3W-HD	8 DI HD Modülü (8 konektör x 4 bağlantı noktası)(2 ve 3 kablolü)	1315190000	56,00 €	1

Time Stamp				
UR20-2DI-P-TS	2 DI Modülü (2, 3, 3 + Toprak kablolü) Time Stamp, Sensör ve Transmitter uygulamaları	1460140000	74,00 €	1
UR20-4DI-P-TS	4 DI Modülü (2, 3, 3 + Toprak kablolü) Time Stamp, Sensör ve Transmitter uygulamaları	1460150000	167,00 €	1

Dijital Output Modülleri				
UR20-4DO-P	4 DO Modülü (2, 3, 3 + Toprak kablolü) 0.5A/ kanal	1315220000	48,50 €	1
UR20-4DO-N	5 DO Modülü (2, 3, 3 + Toprak kablolü) 0.5A/ kanal, Negatif Anahtarlama	1315410000	62,00 €	1
UR20-4DO-P-2A	4 DO Modülü (2, 3, 3 + Toprak kablolü) 2A/ kanal	1315230000	78,00 €	1
UR20-4DO-PN-2A	4 DO Modülü (2, 3, 3 + Toprak kablolü) 2A/ kanal, Pozitif ve Negatif anahtarlama	1394420000	111,00 €	1
UR20-4DO-N-2A	5 DO Modülü (2, 3, 3 + Toprak kablolü) 2A/ kanal, Negatif anahtarlama	1315420000	93,00 €	1
UR20-8DO-N	8 DO Modülü Negatif Anahtarlama	1315430000	90,00 €	1
UR20-8DO-P	8 DO Modülü (2 kablolü) 0.5A/ kanal	1315240000	75,00 €	1
UR20-16DO-P	16 DO Modülü (1 kablolü) 0.5A/ kanal Pozitif Anahtarlama	1315250000	114,00 €	1
UR20-16DO-N	16 DO Modülü (1 kablolü) 0.5A/ kanal Negatif Anahtarlama	1315440000	108,00 €	1
UR20-16DO-P-PLC-INT	16 DO Modülü (PLC Interface) 0.5A/ kanal Pozitif Anahtarlama	1315270000	132,00 €	1
UR20-16DO-N-PLC-INT	16 DO Modülü (PLC Interface) 0.5A/ kanal Negatif Anahtarlama	1315450000	132,00 €	1
UR20-8DO-P-2W-HD	8 DO HD Modülü (2 kablolü) 0.5A/ kanal	1509830000	69,00 €	1

Röle ve SS Röle Modülleri				
UR20-4RO-SSR-255	4 DO Solid State Röle 0.5A/ kontak	1315540000	123,50 €	1
UR20-4RO-CO-255	4 DO Change Over Röle 6A/ kontak 277V AC/DC	1315550000	108,00 €	1

Analog Input Modülleri				
Voltaj (0...5 V, ±5 V, 0...10 V, ±10 V, 1...5 V, 2...10 V), Akım (0...20 mA, 4...20 mA)				
UR20-4AI-UI-16	4 AI Modülü (2, 3, 3 + FE kablolü) 16 Bit	1315620000	217,00 €	1
UR20-4AI-UI-16-DIAG	4 AI Modülü (2, 3, 3 + FE kablolü) 16 Bit, diagnosis	1315690000	244,00 €	1
UR20-4AI-UI-16-HD	4 AI HD Modülü (2, 3, 3 + FE kablolü) 16 Bit	1506920000	212,00 €	1



UR20-8AI-PLC-INT



UR20-8AI-16-DIAG-HD



UR20-4AO-UI-16-HD



UR20-8DI-PN-FSOE



UR20-2CNT-100



UR20-1SSI



UR20-4AI-RTD-DIAG

Tip	Açıklama	Sipariş No	Fiyat/Birim	Ambalaj
UR20-4AI-UI-16-DIAG-HD	4 AI HD Modülü (2, 3, 3 + FE kablolu) 16 Bit, diagnosis	1506910000	244,00 €	1
UR20-4AI-UI-12	4 AI Modülü (2, 3, 3 + FE kablolu) 12 Bit	1394390000	195,00 €	1
Akım (0 – 20 mA, 4 – 20 mA)				
UR20-8AI-PLC-INT	8 AI Modülü (PLC Interface) 16 Bit	1315670000	227,50 €	1
UR20-8AI-16-HD	8 AI HD Modülü 16 Bit	1315650000	225,00 €	1
UR20-8AI-16-DIAG-HD	8 AI HD Modülü 16 Bit, diagnosis	1315720000	259,00 €	1
Analog Output Modülü				
Voltaj (0...5 V, ±5 V, 0...10 V, ±10 V, 1...5 V, 2...10 V), Akım (0...20 mA, 4...20mA)				
UR20-4AO-UI-16	4 AO Modülü (2 ve 4 kablolu)16 Bit	1315680000	255,00 €	1
UR20-4AO-UI-16-DIAG	4 AO Modülü (2 ve 4 kablolu)16 Bit, diagnosis	1315730000	277,00 €	1
UR20-4AO-UI-16-HD	4 AO HD Modülü (2 ve 4 kablolu)16 Bit	1510690000	225,00 €	1
UR20-4AO-UI-16-DIAG-HD	4 AO HD Modülü (2 ve 4 kablolu)16 Bit, diagnosis	1506930000	259,00 €	1
Not: HD modüllere ait olan konektörleri ayrı şekilde sipariş edilmelidir.				
Load Cell Modülü				
UR20-2AI-SG-24-DIAG	Load Cell modülü 2 kanal	1990070000	275,00 €	1
Enerji İzleme Modülü				
UR20-3EM-230V-AC	1 / 5 A 3 faz enerji izleme modülü (Aktif, reaktif güç, 31. Harmonik)	2007420000	240,00 €	1
Safe I/O Modülleri				
UR20-4DI-4DO-PN-FSOE	SIL 3 Güvenlik rölesi 4DI Fail Safe over EtherCAT	1529780000	310,50 €	1
UR20-4DI-4DO-PN-FSPS	SIL 3 Güvenlik rölesi 4DI PROFIsafe	1335060000	328,00 €	1
UR20-8DI-PN-FSOE	SIL 3 Güvenlik rölesi 8DI Fail Safe over EtherCAT	1529800000	242,00 €	1
UR20-8DI-PN-FSPS	SIL 3 Güvenlik rölesi 8DI PROFIsafe	1335070000	259,00 €	1
SIL Güvenlik Röleleri				
UR20-PF-0-1DI-SIL	24V SIL 3 Güvenlik rölesi. Bir acil stop butonu için tek DI	1335030000	227,50 €	1
UR20-PF-0-2DI-DELAY-SIL	24V SIL 3 Güvenlik rölesi. 2 acil stop butonu için 2 DI	1335040000	260,00 €	1
UR20-PF-0-2DI-SIL	24V SIL 3 Güvenlik rölesi. 2 acil stop butonu için 2 DI ve SS çıkış, Geciktirme ayarlı	1335050000	245,00 €	1
Dijital Counter ve Pulse Modulation Modülleri				
UR20-1CNT-100-1DO	1 Kanal Dijital Counter Modülü 32Bit 100Khz,Reset, Digital Output	1315570000	176,50 €	1
UR20-1CNT-500	1 Kanal Dijital Counter Modülü 32Bit 500Khz, Reset	1315580000	197,50 €	1
UR20-2CNT-100	2 Kanal Dijital Counter Modülü 32Bit 100Khz	1315590000	200,00 €	1
UR20-2FCNT-100	2 Kanal Dijital Frekans Counter Modülü 32Bit 100Khz	1508080000	179,00 €	1
UR20-2PWM-PN-0.5A	2 kanal Pulse width Modulation Modülü 0.5A/ kanal Max 40 Khz	1315600000	195,00 €	1
UR20-2PWM-PN-2A	2 kanal Pulse width Modulation Modülü 2A/ kanal Max 40 Khz	1315610000	228,00 €	1
Serial Arayüz ve Interface Modülleri				
UR20-1SSI	RS422 (Synchronous serial interface), 125kHz - 2MHz	1508090000	225,00 €	1
UR20-1COM-232-485-422	RS232, RS485, RS422, 300 - 115.200 Bit/s, RS232 veya RS485/422 Interface	1315750000	230,00 €	1
UR20-1COM-SAI-PRO	IP67 Interface, 250 veya 500 kBit/s, SAI-PRO Subbus	2007430000	225,00 €	1
UR20-4COM-IO-LINK	4 Port I/O link interface modülü	1315740000	220,00 €	1
Sıcaklık Algulama Modülleri				
Sensör: Pt100, 200, 500, 1000; Ni100, 120, 200, 500, 1000; Cu10; 40 Ω - 4000 Ω aralık direnç giriş değeri				
UR20-4AI-RTD-DIAG	4 AI RTD Sensör Bağlantı Modülü (2, 3, 4 kablolu) 16 Bit	1315700000	216,00 €	1
Sensör: J, K, T, B, N, E, R, S, L, U, C, mV				
UR20-4AI-TC-DIAG	4 AI TC Sensör Bağlantı Modülü 16 Bit	1315710000	228,00 €	1
Besleme Modülleri				
UR20-PF-I	Besleme Modülü 10A Input	1334710000	43,00 €	1
UR20-PF-O	Besleme Modülü 10A Output	1334740000	43,00 €	1

U-Remote I/O Modülleri



UR20-16AUX-I



UR20-EBK-ACC



UR20-PG0.35



SAI-AU M8 SB 8DIO



SAI-AU M8 SB 8DO 2A



SAI-AU M12 SB 4PT100



UR67-PN-HP-8IOL-12-30M



UR67-MP-HP-16DI-12-60M

Tip	Açıklama	Sipariş No	Fiyat/Birim	Ambalaj
AUX Besleme ve Potansiyel Dağıtım Modülleri				
UR20-16AUX-I	Potansiyel Dağıtım Modülü Input	1334770000	32,00 €	1
UR20-16AUX-O	Potansiyel Dağıtım Modülü Output	1334780000	32,00 €	1
UR20-16AUX-FE	Potansiyel Dağıtım Modülü Toprak	1334790000	32,00 €	1
UR20-16AUX-GND-I	Potansiyel Dağıtım Modülü GND-I	1334800000	32,00 €	1
UR20-16AUX-GND-O	Potansiyel Dağıtım Modülü GND-O	1334810000	32,00 €	1
Pasif Modül				
UR20-ES	Boş Modül Yapısı	1315770000	26,50 €	1
Aksesuarlar				
UR20-EBK-ACC	Sonlandırma Plakaları	1346610000	10,00 €	5
DEK 5/8-11.5 MC NE WS	Modül Markalama	1341630000	0,671 TL	500
UR20-SM-ACC	Markalama Tutucu Aparat Opsiyonel	1339920000	1,50 €	20
UR20-PG0.35	HD Modüller için konektör	1469340000	3,75 €	8
Montaj Yardımcı Aparatları				
Multi-stripax 6-16	6, 10, 16 mm ² kesite sahip sert ve yumuşak izolasyonlu kablolar için	9202210000	3.814,00 TL	1
PWZ-UR20-HD		1525820000	1.150,00 TL	1
Not: HD modüllere ait olan konektörleri ayrı şekilde sipariş edilmelidir.				
U-Remote IP 67				
U-Remote IP 67 Subbus Modülleri				
Programlanabilir Dijital Modüller				
SAI-AU M8 SB 8DIO	8 kanal konfigüre edilebilir, M8, 0.5A,	1938630000	393,00 €	1
SAI-AU M12 SB 8DIO	8 kanal konfigüre edilebilir, M12, 0.5A,	1938640000	295,00 €	1
Dijital Input Modülleri				
SAI-AU M8 SB 8DI	8 DI, M8	1938600000	222,00 €	1
SAI-AU M12 SB 8DI	8 DI, M12	1938610000	178,75 €	1
Dijital Output Modülleri				
SAI-AU M8 SB 8DO 2A	8 DO, M8, kanal başı 2A	1938660000	424,00 €	1
SAI-AU M12 SB 8DO 2A	8 DO, M12, kanal başı 2A	1938680000	285,00 €	1
Analog Input Modülleri				
SAI-AU M12 SB 4AI	4 AI, M12, 12bit, Voltaj (0 - 10 V, ±10 V), Akım (0 - 20 mA, 4 - 20 mA)	1938690000	373,45 €	1
Analog Output Modülleri				
SAI-AU M12 SB 4AO	4 AO, M12, 12bit, Voltaj (0 - 10 V, ±10 V), Akım (0 - 20 mA, 4 - 20 mA)	1938700000	458,65 €	1
Fonksiyonel Modüller				
SAI-AU M12 SB 4PT100	4 adet PT100 input, M12	1938710000	458,65 €	1
SAI-AU M12 SB 4Thermo	4 adet thermocouple input, M12	1938720000	458,65 €	1
SAI-AU M12 SB 2Counter	2 adet counter input, M12	1938730000	376,75 €	1
IO-Link Modülleri				
UR67-PN-HP-8IOL-12-30M	4 Typ A ve 4 Typ B Port, 12 DI veya 8 DO programlanabilir, (M12)	2426250000	527,00 €	1
UR67-PN-HP-8IOL-12-60M	4 Typ A(0.5A) ve 4 Typ B(2A) Port, 12 DI veya 8 DO programlanabilir, (M12)	2426260000	527,00 €	1
Multiprotocol Modülleri (PROFINET/EtherNet/IP)				
Güç Kaynağı Bağlantısı : M12, L-coded (16 A)				
UR67-MP-HP-16DI-12-60M	16 DI, (M12)	2426270000	508,00 €	1
UR67-MP-HP-16DO-12-60M	16 DO, (M12)	2426280000	548,00 €	1
UR67-MP-HP-8DIDO-12-60M	8 DI, 8 DO, (M12)	2426290000	535,00 €	1
Güç Kaynağı Bağlantısı : 7/8", 5-pole				
UR67-MP-78-8DIDO-12-60M	8 DI, 8 DO, (M12)	2426320000	527,00 €	1
UR67-MP-78-16DI-12-60M	16 DI, (M12)	2426300000	500,00 €	1
UR67-MP-78-16DO-12-60M	16 DO, (M12)	2426310000	540,00 €	1



UR67-PB-12-8DI-8-30K



SAI-AU M8 CAN 16DI/8DO



SAI-AU M8 DN 16DI



UV66-ADV-7-CAP-W

Tip	Açıklama	Sipariş No	Fiyat/Birim	Ambalaj
PROFIBUS-DP Modülleri				
Güç Kaynağı Bağlantısı : M12, 5-pole, A-coded				
UR67-PB-12-8DI-8-30K	8 DI, (M8)	2426360000	368,50 €	1
UR67-PB-12-8DIO-8-30K	8 programlanabilir universal port (M8)	2426330000	423,65 €	1
Güç Kaynağı Bağlantısı : 7/8", 5-pole				
UR67-PB-78-16DI-12-60K	16 DI, (M12)	2426370000	471,50 €	1
UR67-PB-78-16DIO-12-60K	16 programlanabilir universal port (M12)	2426340000	553,00 €	1
UR67-PB-78-16DI-12-60M	16 DI, (M12)	2426390000	500,00 €	1
UR67-PB-78-16DO-12-60M	16 DO, (M12)	2426400000	540,00 €	1
UR67-PB-78-8DIDO-12-60M	8 DI, 8 DO, (M12)	2426380000	535,00 €	1
CANopen Modülleri				
Güç Kaynağı Bağlantısı : M12, 5-pole, A-coded				
SAI-AU M8 CAN 16DI/8DO	16DI, 8 DO programlanabilir, (M8)	1906690000	533,00 €	1
SAI-AU M12 CAN 16DI/8DO	16DI, 8 DO programlanabilir, (M12)	1906660000	516,00 €	1
SAI-AU M8 CAN 16DI	16 DI, (M8)	1906680000	449,90 €	1
SAI-AU M12 CAN 16DI	16 DI, (M12)	1906650000	450,00 €	1
SAI-AU M12 CAN AI/AO/DI	4 AI, 2 AO, 4 DI, (M12)	1906670000	679,00 €	1
DeviceNet Modülleri				
Güç Kaynağı Bağlantısı : M12, 5-pole, A-coded				
SAI-AU M8 DN 16DI	16 DI, (M8)	1906730000	558,00 €	1
SAI-AU M12 DN 16DI	16 DI, (M12)	1906700000	780,00 €	1
SAI-AU M8 DN 16DI/8DO	16DI, 8 DO programlanabilir, (M8)	1906740000	517,00 €	1
SAI-AU M12 DN 16DI/8DO	16DI, 8 DO programlanabilir, (M12)	1906710000	822,00 €	1
SAI-AU M12 DN AI/AO/DI	4 AI, 2 AO, 4 DI, (M12)	1906720000	624,00 €	1
SAI-AU M12 DN GW 16DI	16 DI, Subbus sistemi için Gateway modülü	1938570000	492,00 €	1
u-view Multitouch-Panels				
* UV66-ADV-10-CAP-W	Kapasitif 10.1" ekran boyutu, ARM Cortex A9 1 GHz NXP® i.MX6 DualLite / 4MB	2555840000	2.250,00 €	1
* UV66-ADV-15-CAP-W	Kapasitif 15.6" ekran boyutu, ARM Cortex A9 1 GHz NXP® i.MX6 DualLite / 4MB	2555850000	2.535,00 €	1
* UV66-ADV-7-CAP-W	Kapasitif 7" ekran boyutu, ARM Cortex A9 1 GHz NXP® i.MX6 DualLite / 4MB	2555830000	1.800,00 €	1
* UV66-BAS-10-RES-W	Rezistif 10.1" ekran boyutu, ARM Cortex A8 processor Freescale® i.MX535 1 GHz / 4MB	2555820000	1.575,00 €	1
* UV66-BAS-4-RES-W	Rezistif 4.3" ekran boyutu, ARM Cortex A8 processor Freescale® i.MX535 1 GHz / 4MB	2555800000	900,00 €	1
* UV66-BAS-7-RES-W	Rezistif 7" ekran boyutu, ARM Cortex A8 processor Freescale® i.MX535 1 GHz / 4MB	2555810000	1.125,00 €	1

U-REMOTE YEDEK PARÇALARI

“İhtiyaç durumunda u-remote modüllerine ait olan yedek parçaları taban, elektronik modül ve konnektör girişleri şeklinde 3 farklı bileşen olarak ayrı ayrı sipariş edebilirsiniz.”



Ana Ürünler		Konnektör Parçaları-Ambalaj Adeti 5		Elektronik Kart Kısmı-Ambalaj Adeti 1		Taban Kısmı - Ambalaj adeti 5	
UR20-FBC-PB-DP	1334870000	UR20-PK-1334870000-SP	1361520000				
UR20-FBC-PN-HRT	1334880000	UR20-PK-1334880000-SP	1484120000				
UR20-FBC-EC	1334910000	UR20-PK-1334910000-SP	1484440000				
UR20-FBC-MOD	1334930000	UR20-PK-1334930000-SP	1484130000				
UR20-4DI-P	1315170000	UR20-PK-1315170000-SP	1346440000	UR20-EM-1315170000-SP	1346640000	UR20-BM-SP	1350930000
UR20-8DI-P-2W	1315180000	UR20-PK-1315180000-SP	1346430000	UR20-EM-1315080000-SP	1346650000	UR20-BM-SP	1350930000
UR20-8DI-P-3W	1394400000	UR20-PK-1394400000-SP	1411430000	UR20-EM-1394400000-SP	1434220000	UR20-BM-SP	1350930000
UR20-16DI-P	1315200000	UR20-PK-1315200000-SP	1346400000	UR20-EM-1315200000-SP	1346680000	UR20-BM-SP	1350930000
UR20-16DI-P-PLC-INT	1315210000	UR20-PK-1315210000-SP	1346590000	UR20-EM-1315210000-SP	1346690000	UR20-BM-SP	1350930000
UR20-2DI-P-TS	1460140000	UR20-PK-1460140000-SP	1484110000	UR20-EM-1460140000-SP	1463690000	UR20-BM-SP	1350930000
UR20-4DI-P-TS	1460150000	UR20-PK-1460150000-SP	1484430000	UR20-EM-1460150000-SP	1463680000	UR20-BM-SP	1350930000
UR20-4DO-P	1315220000	UR20-PK-1315220000-SP	1483960000	UR20-EM-1315220000-SP	1346700000	UR20-BM-SP	1350930000
UR20-4DO-P-2A	1315230000	UR20-PK-1315230000-SP	1483970000	UR20-EM-1315230000-SP	1346710000	UR20-BM-SP	1350930000
UR20-4DO-PN-2A	1394420000	UR20-PK-1394420000-SP	1483980000	UR20-EM-1394420000-SP	1480950000	UR20-BM-SP	1350930000
UR20-8DO-P	1315240000	UR20-PK-1315240000-SP	1346410000	UR20-EM-1315240000-SP	1346720000	UR20-BM-SP	1350930000
UR20-16DO-P	1315250000	UR20-PK-1315250000-SP	1483990000	UR20-EM-1315250000-SP	1346730000	UR20-BM-SP	1350930000
UR20-16DO-P-PLC-INT	1315270000	UR20-PK-1315270000-SP	1483940000	UR20-EM-1315270000-SP	1346740000	UR20-BM-SP	1350930000
UR20-4RO-SSR-255	1315540000	UR20-PK-1315540000-SP	1484000000	UR20-EM-1315540000-SP	1347120000	UR20-BM-SP	1350930000
UR20-4RO-CO-255	1315550000	UR20-PK-1315550000-SP	1346500000	UR20-EM-1315550000-SP	1347130000	UR20-BM-SP	1350930000
UR20-1CNT-100-1DO	1315570000	UR20-PK-1315570000-SP	1346520000	UR20-EM-1315570000-SP	1347140000	UR20-BM-SP	1350930000
UR20-2CNT-100	1315590000	UR20-PK-1315590000-SP	1346540000	UR20-EM-1315590000-SP	1347150000	UR20-BM-SP	1350930000
UR20-2PWM-PN-0.5A	1315600000	UR20-PK-1315600000-SP	1484010000	UR20-EM-1315600000-SP	1347180000	UR20-BM-SP	1350930000
UR20-2PWM-PN-2A	1315610000	UR20-PK-1315610000-SP	1346550000	UR20-EM-1315610000-SP	1347190000	UR20-BM-SP	1350930000
UR20-4AI-UI-16	1315620000	UR20-PK-1315620000-SP	1484020000	UR20-EM-1315620000-SP	1347200000	UR20-BM-SP	1350930000
UR20-4AI-UI-12	1394390000	UR20-PK-1394390000-SP	1484030000	UR20-EM-1394390000-SP	1434230000	UR20-BM-SP	1350930000
UR20-8AI-PLC-INT	1315670000	UR20-PK-1315670000-SP	1483950000	UR20-EM-1315670000-SP	1347250000	UR20-BM-SP	1350930000
UR20-4AI-TC-DIAG	1315710000	UR20-PK-1315710000-SP	1484050000	UR20-EM-1315710000-SP	1435740000	UR20-BM-SP	1350930000
UR20-4AI-RTD-DIAG	1315700000	UR20-PK-1315700000-SP	1484040000	UR20-EM-1315700000-SP	1347290000	UR20-BM-SP	1350930000
UR20-4AO-UI-16	1315680000	UR20-PK-1315680000-SP	1484070000	UR20-EM-1315680000-SP	1347270000	UR20-BM-SP	1350930000
UR20-PF-I	1334710000	UR20-PK-1334710000-SP	1346460000	UR20-EM-1334710000-SP	1347370000	UR20-BM-PF-I-SP	1350940000
UR20-PF-O	1334740000	UR20-PK-1334740000-SP	1346480000	UR20-EM-1334740000-SP	1347420000	UR20-BM-PF-O-SP	1350950000
UR20-PF-O-1DI-SIL	1335030000	UR20-PK-1335030000-SP	1346560000	UR20-EM-1335030000-SP	1347520000	UR20-BM-SIL-SP	1350970000
UR20-PF-O-2DI-SIL	1335050000	UR20-PK-1335050000-SP	1346570000	UR20-EM-1335050000-SP	1347540000	UR20-BM-SIL-SP	1350970000
UR20-PF-O-2DI-DELAY-SIL	1335040000	UR20-PK-1335040000-SP	1484100000	UR20-EM-1335040000-SP	1347530000	UR20-BM-SIL-SP	1350970000
UR20-16AUX-I	1334770000	UR20-PK-1334770000-SP	1346450000	UR20-EM-1334770000-SP	1347450000	UR20-BM-SP	1350930000
UR20-16AUX-O	1334780000	UR20-PK-1334780000-SP	1484080000	UR20-EM-1334780000-SP	1347470000	UR20-BM-SP	1350930000
UR20-16AUX-FE	1334790000	UR20-PK-1334790000-SP	1346490000	UR20-EM-1334790000-SP	1347480000	UR20-BM-SP	1350930000
UR20-16AUX-GND-I	1334800000	UR20-PK-1334800000-SP	1346470000	UR20-EM-1334800000-SP	1347490000	UR20-BM-SP	1350930000
UR20-16AUX-GND-O	1334810000	UR20-PK-1334810000-SP	1484090000	UR20-EM-1334810000-SP	1347500000	UR20-BM-SP	1350930000
UR20-ES	1315770000	UR20-PK-1315770000-SP	1346510000	UR20-EM-1315770000-SP	1347370000	UR20-BM-SP	1350930000

SAI - Sensör Aktuatör Arayüzleri

SAI blokları sensör aktuatör sinyallerini sahada toplayarak PLC'ye aktarmaktan sorumludur. Bu kablolama ve servis masraflarını ve sürelerini azaltmak anlamına gelmektedir. Önceden hazırlanmış iletkenler ve M8/M12 konnektörlerle çalışıldığı için bağlantı hataları sıfıra indirilir. Weidmüller SAI bloklarının özellikleri şöyledir:

- Güvenilirlik
- Uzun vade de düşük maliyet
- Uzun ömürlülük
- Kısa arıza kaynaklı duruş süreleri

SAI Pasif

Bu modüller 4, 6 ve 8 kanallı olarak, M8,M12 konnektörlü ve 3, 4 ve 5 kutuplu olacak şekilde tercih edilebilirler. Bloklar makina üzerine direkt olarak monte edilirler. İnce ve sağlamdırlar. IP 68 koruma sınıfında üretilirler.

- SAI-F, Dağıtıcısı SAI-4/6/8-F Entegre edilmiş kablolu versiyon.
- SAI-M, Dağıtıcısı SAI-4/6/8-M Kablosuz versiyon.

SAI Aksesuarları

- Soketler ve fişler
- Sensör kabloları
- Markalama sistemleri
- El aletleri ve daha fazlası

Fieldbus Elemanları

Özellikle patlayıcı ortamlarda kullanılan FBCon Fieldbus dağıtıcılarını kapsar. Endüstriyel uygulamalar için gerilim korumalı ve akım sınırlayıcı versiyonları vardır.



SAI - Sensör Aktuatör Arayüzler



SAI-4-F 4P PUR 3M



SAI-6-F 4P PUR 3M



SAI-8-F 4P PUR 3M



SAI-4-M 4P M12



SAI-6-M 4P M12



SAI-8-M 4P M12

Tip	Kablo Uzunluğu	Konnektör Kutup Sayısı	Sipariş No	Fiyat/Birim	Ambalaj
SAI Pasif Modüller ve Aksesuarları					
SAI / Sensör-Aktuatör Arayüzleri - M12 - IP68 Hazır Kablolu					
4 - Kanal					
SAI-4-F 4P PUR 3M	3 Metre	4-kutup	9456180000	79,70 €	1
SAI-4-F 4P PUR 5M	5 Metre	4-kutup	9456190000	80,80 €	1
SAI-4-F 4P PUR 10M	10 Metre	4-kutup	9456200000	81,90 €	1
SAI-4-F 4P PUR 15M	15 Metre	4-kutup	9456210000	126,50 €	1
SAI-4-F 4P PUR 20M	20 Metre	4-kutup	9456230000	164,50 €	1
SAI-4-F 5P PUR 3M	3 Metre	5-kutup	9456320000	83,00 €	1
SAI-4-F 5P PUR 5M	5 Metre	5-kutup	9456330000	97,20 €	1
SAI-4-F 5P PUR 10M	10 Metre	5-kutup	9456340000	116,80 €	1
SAI-4-F 5P PUR 15M	15 Metre	5-kutup	9456350000	161,60 €	1
SAI-4-F 5P PUR 20M	20 Metre	5-kutup	9456370000	202,50 €	1
6 - Kanal					
SAI-6-F 4P PUR 3M	3 Metre	4-kutup	9456460000	115,80 €	1
SAI-6-F 4P PUR 5M	5 Metre	4-kutup	9456470000	116,80 €	1
SAI-6-F 4P PUR 10M	10 Metre	4-kutup	9456480000	117,90 €	1
SAI-6-F 4P PUR 15M	15 Metre	4-kutup	9456490000	148,50 €	1
SAI-6-F 4P PUR 20M	20 Metre	4-kutup	9456510000	195,50 €	1
SAI-6-F 5P PUR 3M	3 Metre	5-kutup	9456600000	116,80 €	1
SAI-6-F 5P PUR 5M	5 Metre	5-kutup	9456610000	118,00 €	1
SAI-6-F 5P PUR 10M	10 Metre	5-kutup	9456620000	145,20 €	1
SAI-6-F 5P PUR 15M	15 Metre	5-kutup	9456630000	183,40 €	1
SAI-6-F 5P PUR 20M	20 Metre	5-kutup	9456650000	213,50 €	1
8 - Kanal					
SAI-8-F 4P PUR 3M	3 Metre	4-kutup	9456740000	119,00 €	1
SAI-8-F 4P PUR 5M	5 Metre	4-kutup	9456750000	120,00 €	1
SAI-8-F 4P PUR 10M	10 Metre	4-kutup	9456760000	121,20 €	1
SAI-8-F 4P PUR 15M	15 Metre	4-kutup	9456770000	162,70 €	1
SAI-8-F 4P PUR 20M	20 Metre	4-kutup	9456790000	215,00 €	1
SAI-8-F 5P PUR 3M	3 Metre	5-kutup	9456880000	131,00 €	1
SAI-8-F 5P PUR 5M	5 Metre	5-kutup	9456890000	136,50 €	1
SAI-8-F 5P PUR 10M	10 Metre	5-kutup	9456900000	177,00 €	1
SAI-8-F 5P PUR 15M	15 Metre	5-kutup	9456910000	252,30 €	1
SAI-8-F 5P PUR 20M	20 Metre	5-kutup	9456930000	254,40 €	1

Tip	Açıklama	Konnektör Kutup Sayısı	Sipariş No	Fiyat/Birim	Ambalaj
SAI Pasif Modüller ve Aksesuarları					
SAI / Sensör-Aktuatör Arayüzleri - M12 - IP67					
4 - Kanal					
SAI-4-M 4P M12	Komple Modül	4-kutup	1705920000	75,40 €	1
SAI-4-M 4P M12 UT	Ana Modül	4-kutup	1705921000	55,70 €	2
SAI-4-M 5P M12	Komple Modül	5-kutup	1701230000	78,60 €	1
SAI-4-M 5P M12 UT	Ana Modül	5-kutup	1701231000	65,50 €	2
6 - Kanal					
SAI-6-M 4P M12	Komple Modül	4-kutup	1705930000	90,60 €	1
SAI-6-M 4P M12 UT	Ana Modül	4-kutup	1705931000	71,00 €	2
SAI-6-M 5P M12	Komple Modül	5-kutup	1701240000	101,00 €	1
SAI-6-M 5P M12 UT	Ana Modül	5-kutup	1701241000	85,00 €	2
8 - Kanal					
SAI-8-M 4P M12	Komple Modül	4-kutup	1705940000	106,00 €	1

Serinin devamı sayfa 87

Tip	Açıklama	Konnektör Kutup Sayısı	Sipariş No	Fiyat/Birim	Ambalaj
SAI-8-M 4P M12 UT	Ana Modül	4-kutup	1705941000	92,00 €	2
SAI-8-M 5P M12	Komple Modül	5-kutup	1701250000	88,50 €	1
SAI-8-M 5P M12 OL UT	Ana Modül	5-kutup	1740191000	86,00 €	2
4/6/8 - Kanal Bağlantı Modülü					
SAI-4/6/8-MH BLZF3.5	Yaylı Bağlantı Modülü		1752080000	28,50 €	1
SAI-4/6/8-MH BL3.5	Vidalı Bağlantı Modülü		1724750000	21,00 €	1

Tip	Kablo Uzunluğu	Konnektör Kutup Sayısı	Sipariş No	Fiyat/Birim	Ambalaj
-----	----------------	------------------------	------------	-------------	---------

SAI Pasif Modüller ve Aksesuarları**SAI / Sensör-Aktuatör Arayüzleri - M8 - IP68 Hazır Kablolu****4 - Kanal**

SAI-4-F 3P M8 PUR 5M	5 Metre	3-kutup	1784640000	110,50 €	1
SAI-4-F 3P M8 PUR 10M	10 Metre	3-kutup	1784630000	213,00 €	1
SAI-4-F 4P M8 PUR 5M	5 Metre	4-kutup	1784600000	139,00 €	1
SAI-4-F 4P M8 PUR 10M	10 Metre	4-kutup	1784590000	214,00 €	1

8 - Kanal

SAI-8-F 3P M8 PUR 5M	5 Metre	3-kutup	1784620000	122,50 €	1
SAI-8-F 3P M8 PUR 10M	10 Metre	3-kutup	1784610000	163,00 €	1
SAI-8-F 4P M8 PUR 5M	5 Metre	4-kutup	1784580000	143,00 €	1
SAI-8-F 4P M8 PUR 10M	10 Metre	4-kutup	1784570000	199,00 €	1

SAI / Sensör-Aktuatör Arayüzleri - M8 - IP68**4 - Kanal**

SAI-4-M 3P M8	Komple Modül	3-kutup	1784680000	139,00 €	1
SAI-4-M 4P M8	Komple Modül	4-kutup	1784700000	142,00 €	1

8 - Kanal

SAI-8-M 3P M8	Komple Modül	3-kutup	1784670000	154,00 €	1
SAI-8-M 4P M8	Komple Modül	4-kutup	1784690000	157,00 €	1

SAI / Sensör-Aktuatör Arayüzleri - M8 - IP68 Hazır Kablolu**4 - Kanal**

SAI-4-F 3P M8 L 5M	5 Metre	3-kutup	1828720000	66,50 €	1
SAI-4-F 3P M8 L 10M	10 Metre	3-kutup	1828710000	116,00 €	1
SAI-4-F 4P M8 L 5M	5 Metre	4-kutup	1849680000	82,00 €	1
SAI-4-F 4P M8 L 10M	10 Metre	4-kutup	1849690000	171,00 €	1

6 - Kanal

SAI-6-F 3P M8 L 5M	5 Metre	3-kutup	1828700000	84,00 €	1
SAI-6-F 3P M8 L 10M	10 Metre	3-kutup	1828690000	110,00 €	1
SAI-6-F 4P M8 L 5M	5 Metre	4-kutup	1849700000	140,00 €	1
SAI-6-F 4P M8 L 10M	10 Metre	4-kutup	1849670000	190,00 €	1

8 - Kanal

SAI-8-F 3P M8 L 5M	5 Metre	3-kutup	1828680000	118,00 €	1
SAI-8-F 3P M8 L 10M	10 Metre	3-kutup	1828670000	137,50 €	1
SAI-8-F 4P M8 L 5M	5 Metre	4-kutup	1828620000	137,50 €	1
SAI-8-F 4P M8 L 10M	10 Metre	4-kutup	1828610000	196,50 €	1

10 - Kanal

SAI-10-F 3P M8 L 5M	5 Metre	3-kutup	1828660000	176,00 €	1
SAI-10-F 3P M8 L 10M	10 Metre	3-kutup	1828650000	210,00 €	1

12 - Kanal

SAI-12-F 3P M8 L 5M	5 Metre	3-kutup	1828640000	206,00 €	1
SAI-12-F 3P M8 L 10M	10 Metre	3-kutup	1828630000	246,00 €	1



SAI-4-F 3P M8 PUR 5M



SAI-8-F 3P M8 PUR 5M



SAI-4-F 3P M8 L 5M



SAI-8-F 3P M8 L 5M

SAI - Sensör Aktuatör Arayüzler



SAISW-3/9



SAIS-3/9



SAIS-3-IDC-M12B-COD



SAISM-5/8S-M12-5P-B-COD



SAIS-M-5/8S-M12-5P-A-COD



SAISM-4/8S-M12-4P-D-COD



SAISM-4/8S-M12-4P-D-ZF



SAIS-M8-3P



SAISM-M8-3P-(IF)

Tip	Açıklama	Sipariş No	Fiyat/Birim	Ambalaj
SAI Pasif Modüller ve Aksesuarları				
M12 Sensör Aktuatör Konektörleri (A-COD/ IP67)				
SAIS-3/9	M12 Düz,Erkek, 3 Kutup PG 9	1021480000	11,00 €	1
SAIS-4/9	M12 Düz,Erkek, 4 Kutup PG 9	1807340000	9,50 €	1
SAISW-3/9	M12 Açılı ,Erkek , 3 Kutup PG9	1021290000	11,00 €	1
SAISW-4/9	M12 Açılı ,Erkek , 4 Kutup PG9	1807360000	8,80 €	1
SAIS-5/9	M12 Düz,Erkek, 5 Kutup PG 9	1807350000	9,90 €	1
SAISW-5/9	M12 Açılı ,Erkek , 5 Kutup PG9	1807370000	9,90 €	1
SAIS-5/7-ZF	M12 Düz,Erkek 5 Kutup Yaylı Bağlantı PG7	1906390000	18,00 €	1
SAIS-8/9	M12 Düz,Erkek, 8 Kutup PG 9	1836970000	20,00 €	1
SAIB-3/9	M12 Düz,Dişi,3 Kutup PG9	1021510000	11,00 €	1
SAIB-4/9	M12 Düz,Dişi,4 Kutup PG9	1807230000	9,90 €	1
SAIBW-3/9	M12 Açılı,Dişi,3 Kutup PG9	1021320000	11,00 €	1
SAIBW-4/9	M12 Açılı,Dişi,4 Kutup PG9	1807240000	8,80 €	1
SAIB-5/9	M12 Düz,Dişi,5 Kutup PG9	1807250000	11,00 €	1
SAIBW-5/9	M12 Açılı,Dişi,5 Kutup PG9	1807330000	11,00 €	1
SAIB-5/7-ZF	M12 Düz, Dişi 5 Kutup Yaylı Bağlantı PG7	1924970000	14,00 €	1
Not: PG7 Kablo girişli ürünler için Lütfen irtibat kurunuz				
M12 Sensör Aktuatör Konektörleri (Profibus için / B-COD) Metal				
SAISM 5/8S M12 5P B-COD	M12 Düz,Erkek,5 Kutuplu PG 9 -Metal EMC(IP67)	1784790000	19,70 €	1
SAIBM 5/8S M12 5P B-COD	M12 Düz,Dişi,5 Kutuplu PG 9 -Metal EMC(IP67)	1784780000	19,70 €	1
SAIS-3-IDC-M12B-COD	M12 Düz, Erkek,3 Kutuplu PG 9 -Metal EMC(IP67)	1864730000	32,50 €	1
SAIB-3-IDC-M12B-COD	M12 Düz,Dişi,3 Kutuplu PG 9 -Metal EMC(IP67)	1864740000	32,50 €	1
SAISW-M-5/8 M12 B-COD	M12 Açılı ,Erkek , 5 Kutup PG9	1944570000	30,70 €	1
SAIBW-M-5/8 M12 B-COD	M12 Açılı ,Dişi,5 Kutup PG9	1944580000	30,20 €	1
SAIS 5/9-VA-B-COD	M12 Düz, Erkek,5 Kutuplu PG9 -Paslanmaz Çelik(IP 69K)	1920720000	56,00 €	1
SAIB 5/9-VA-B-COD	M12 Düz,Dişi,5 Kutuplu PG9 - Paslanmaz Çelik(IP69K)	1920730000	55,00 €	1
M12 Sensör Aktuatör Konektörleri (A-COD) Metal				
SAIS-M-5/8S M12 5P A-COD	M12 Düz,Erkek 5 Kutuplu (IP67) PG9	1784740000	24,00 €	1
SAIB-M-5/8S M12 5P A-COD	M12 Düz,Dişi 5 Kutuplu (IP67) PG9	1784750000	24,00 €	1
SAISW-M-5/8 M12	M12 Açılı Erkek 5 Kutuplu (IP67) PG9	1803940000	20,80 €	1
SAIBW-M-5/8 M12	M12 Açılı Dişi 5 Kutuplu (IP67) PG9	1803920000	21,80 €	1
SAIS 5/9-VA	M12 Düz,Erkek 5 Kutuplu Yaylı Bağlantı (IP69K)	1920700000	56,00 €	1
SAIB 5/9-VA	M12 Düz,Dişi 5 Kutuplu Yaylı Bağlantı (IP69K)	1920710000	55,00 €	1
M12 Sensör Aktuatör Konektörleri Endüstriyel Ethernet(D-COD) Metal				
SAISM-4/8S-M12-4P-D-COD	M12 Düz,Erkek 4 Kutuplu (IP67)	1892120000	18,50 €	1
SAIBM-4/8S-M12-4P-D-COD	M12 Düz,Dişi 4 Kutuplu (IP67)	1892130000	18,50 €	1
SAISM-4/8S-M12-4P-D-ZF	M12 Düz,Erkek 4 Kutuplu (IP67)	1892120001	32,20 €	1
SAIBM-4/8S-M12-4P-D-ZF	M12 Düz,Dişi 4 Kutuplu,Yaylı Bağlantı (IP67)	1892130001	32,20 €	1
SAISW-4/8S-M12-4P-D-ZF	M12 Açılı,Erkek 4 Kutuplu,Yaylı Bağlantı (IP67)	1803930001	31,20 €	1
SAIBW-4/8S-M12-4P-D-ZF	M12 Açılı,Erkek 4 Kutuplu,Yaylı Bağlantı (IP67)	1139330000	33,30 €	1
Sensör Aktuatör Konektörleri (M8 PLASTİK)				
SAIS-M8-3P	M8 Düz,Erkek, 3 Kutup	1803860000	10,40 €	1
SAIS-M8-4P	M8 Düz,Erkek, 4 Kutup	1803850000	14,35 €	1
SAIB-M8-3P	M8 Düz,Dişi, ,3 Kutup	1803870000	10,40 €	1
SAIB-M8-4P	M8 Düz,Dişi, ,4 Kutup	1803880000	14,35 €	1
Sensör Aktuatör Konektörleri (M8 METAL)				
SAISM-M8-3P-(IF)	M8 Düz,Erkek, 3 Kutup	1010060000	20,80 €	1
SAISM-M8-4P-(IF)	M8 Düz,Erkek, 4 Kutup	1010070000	21,80 €	1
SAIBM-M8-3P-(IF)	M8 Düz ,Dişi , 3 Kutup	1010080000	20,80 €	1
SAIBM-M8-4P-(IF)	M8 Düz ,Dişi , 4 Kutup	1010090000	21,80 €	1



SAIS-4-IDC M12 small



SAI-Y-5S B2-4 2M12



Screwty Set



PB-DP SUB-D M12 TERM

Tip	Açıklama	Sipariş No	Fiyat/Birim	Ambalaj
Sensör Aktuatör Konektörleri (IDC)				
SAIS-4-IDC M12 small	M12 Düz,Erkek, 4 Kutup	1781550001	10,40 €	1
SAIB-4-IDC-M12 small	M12 Düz,Dişi, 4 Kutup	1781540001	10,50 €	1
SAISW-4-IDC M12	M12 Açılı,Erkek, 4 Kutup	1812870000	21,30 €	1
SAIBW-4-IDC M12	M12 Açılı,Dişi, 4 Kutup	1812890000	21,80 €	1
SAIS-3-IDC M8 small	M8 Düz,Erkek, 3 Kutup	1784040001	11,40 €	1
SAIS-4-IDC M8 small	M8 Düz,Erkek, 4 Kutup	1784060001	12,00 €	1
SAIB-3-IDC-M8 small	M8 Düz,Dişi, 3 Kutup	1784030001	10,90 €	1
SAIB-4-IDC-M8 small	M8 Düz,Dişi, 4 Kutup	1784050001	11,40 €	1

Tip	Açıklama	Sipariş No	Fiyat/Birim	Ambalaj
Dağıtıcı T Konektörler				
SAI-Y-5S B2-4 2M12	Distribution, Pin 2 + 4 Bridged	1783410000	21,80 €	1
SAI-Y-5S PARA 2M12	Parallel Distribution	1783430000	21,80 €	1
SAI-Y-5S- M12/M12	Individual Distribution	1826880000	19,80 €	1
SAI-Y-4-4/2-4 M12/8	Individual Distribution	1783420000	21,80 €	1

Tip	Açıklama	Sipariş No	Fiyat/Birim	Ambalaj
Yardımcı El Aleti				
Screwty Set	Konektör Sıkma El Aleti	1910000000	1.779,00 TL	1

Tip	Açıklama	Ölçü	Sipariş No	Fiyat/Birim	Ambalaj
SAI Pasif Modüller ve Aksesuarları					
Aksesuar					
SAI-SK-M12	SAI M12 Kapak	M12	9456050000	0,55 €	30
SAI-SK M8	SAI M8 Kapak	M8	1802760000	0,90 €	50
SAI-SK M5	SAI M5 Kapak	M5	1855310000	1,50 €	50
SAI-SK-M12-UNI	SAI M12 Kapak	M12 Universal	2330260000	1,20 €	20
ESG 9/20 MC NE WS	Beyaz		1609940000	1,69 TL	200

Tip	Ölçü	Açıklama	Sipariş No	Fiyat/Birim	Ambalaj
SAI Pasif Modüller ve Aksesuarları					
Hazır Bus Kablolar					
SAIL-M8GM8G-4S-0.15U-SB	15 cm	Düz M8 erkek-dişi	1981900015	29,40 €	1
SAIL-M8GM8G-4S-0.3U-SB	30 cm	Düz M8 erkek-dişi	1981900030	28,80 €	1
SAIL-M8GM8G-4S-1.0U-SB	1 m	Düz M8 erkek-dişi	1981900100	31,50 €	1
SAIL-M8GM8G-4S-1.5U-SB	1,5 m	Düz M8 erkek-dişi	1981900150	32,65 €	1
SAIL-M8GM8G-4S-3.0U-SB	3 m	Düz M8 erkek-dişi	1981900300	37,50 €	1
SAIL-M8GM8G-4S-5.0U-SB	5 m	Düz M8 erkek-dişi	1981900500	44,00 €	1
SAIL-M8GM8G-4S-10U-SB	10 m	Düz M8 erkek-dişi	1981901000	60,00 €	1

Tip	Koruma Sınıfı	Sipariş No	Fiyat/Birim	Ambalaj
SAI Pasif Modüller ve Aksesuarları				
Profibus DP Sub D Konektörler				
PB-DP SUB-D M12 TERM	IP30	1140650000	83,55 €	1
PB-DP SUB-D M12 TERM PS	IP30	1140640000	90,10 €	1
PB-DP SUB-D ZF35TERM	IP30	1173220000	72,90 €	1
PB-DP SUB-D ZF35TERM PS	IP30	1173240000	79,50 €	1
PB-DP SUB-D ZF TERM	IP30	1161870000	72,90 €	1
PB-DP SUB-D ZF TERM PS	IP30	1161880000	79,50 €	1



Endüstriyel Ethernet

Endüstriyel ethernet network teknolojisinde günden güne öne çıkan bir standart haline gelmektedir. Çünkü planlama ve üretim aşamasında bu uygulamalardan alınan verim daha fazladır. Üreticiler network ağlarıyla tesisleri birbirine entegre edebilmektedir.

Birçok uygulama haberleşme standartları, yazılımlar, ve protokoller ile belirleniyorsa da, bir network'ün fiziksel yapısının tamamen güvenilir bir şekilde çalışması gerekir. Çünkü endüstride hataların %80'inden fazlası bağlantı hatalarıdır. Örneğin; kablo kırılması vb.

Weidmüller, size uzun ömürlü, bakım gerektirmeyen elektrik bağlantılarını geleneksel ürünlerin yanında yenilikçi ürünlerini de önermektedir. Bu ürünler kontrolörlerden saha bağlantılarına kadar bir çok çeşiti kapsar.

STEADYTEC Teknolojili IE-LINE

Modüler yapısı sayesinde maksimum esneklik sağlar. IP 67 koruma mümkündür.

Endüstriyel alandaki avantajları şunlardır:

- Hızlı
- Güvenli
- Çözüm Odaklı
- Pratik





IE-SW-BL05-5TX



IE-SW-BL08T-7TX-1SC



IE-SW-VL16T-16TX



IE-SW-VL08T-8GT



IE-SW-BL06T-2TX-4POE



IE-SW-BL05-1GT-4GTPOE

Tip	Açıklama	Sipariş No	Fiyat/Birim	Ambalaj
Unmanaged - Yönetilemeyen Ethernet Switchler				
IE-SW-BL05-5TX	5 x RJ45	1240840000	163,80 €	1
IE-SW-BL05T-5TX	5 x RJ45 (-40 ... +75 °C)	1240850000	185,65 €	1
IE-SW-BL05-4TX-1SC	4 x RJ45, 1 x SC Multi-mode	1240890000	280,00 €	1
IE-SW-BL05T-4TX-1SC	4 x RJ45, 1 x SC Multi-mode (-40 ...+75 °C)	1286550000	316,50 €	1
IE-SW-BL05-4TX-1ST	4 x RJ45, 1 x ST Multi-mode	1240880000	280,00 €	1
IE-SW-BL05T-4TX-1ST	4 x RJ45, 1 x ST Multi-mode (-40 ...+75 °C)	1286540000	316,50 €	1
IE-SW-BL05-4TX-1SCS	4 x RJ45, 1 x SC Single-mode	1240870000	458,50 €	1
IE-SW-BL05T-4TX-1SCS	4 x RJ45, 1 x SC Single-mode (-40 ...+75 °C)	1286530000	529,00 €	1
IE-SW-BL08-8TX	8 x RJ45	1240900000	207,50 €	1
IE-SW-BL08T-8TX	8x RJ45, (-40 ...+75 °C)	1286560000	240,00 €	1
IE-SW-BL08-7TX-1ST	7x RJ45, 1 x ST Multi-mode	1412090000	310,50 €	1
IE-SW-BL08-7TX-1SC	7x RJ45, 1 x SC Multi-mode	1412070000	303,00 €	1
IE-SW-BL08T-7TX-1SC	7x RJ45, 1 x SC Multi-mode (-40 ...+75 °C)	1412080000	352,00 €	1
IE-SW-BL08T-7TX-1ST	7x RJ45, 1 x ST Multi-mode (-40 ...+75 °C)	1412100000	352,00 €	1
IE-SW-BL08-7TX-1SCS	7x RJ45, 1 x SC Single-mode	1240950000	515,00 €	1
IE-SW-BL08T-7TX-1SCS	7x RJ45, 1 x SC Single-mode (-40 ...+75 °C)	1286580000	602,00 €	1
IE-SW-BL08-6TX-2ST	6x RJ45, 2 x ST Multi-mode	1240930000	459,00 €	1
IE-SW-BL08-6TX-2SC	6 x RJ45, 2 x SC Multi-mode	1240910000	502,00 €	1
IE-SW-BL08T-6TX-2SC	6 x RJ45, 2 x SC Multi-mode (-40 ...+75 °C)	1240920000	524,00 €	1
IE-SW-BL08T-6TX-2ST	6 x RJ45, 2 x ST Multi-mode (-40 ...+75 °C)	1286570000	533,00 €	1
IE-SW-BL08-6TX-2SCS	6 x RJ45, 2 x SC Single-mode	1412110000	662,00 €	1
IE-SW-BL08T-6TX-2SCS	6 x RJ45, 2 x SC Single-mode (-40 ...+75 °C)	1412120000	787,00 €	1
IE-SW-VL16-16TX	16 x RJ45	1241000000	743,00 €	1
IE-SW-VL16T-16TX	16 x RJ45 (-40 ...+75 °C)	1286590000	900,00 €	1
IE-SW-VL09T-6TX-3SC	6 x RJ45, 3 x SC Multi-mode (-40 ...+75 °C)	1240980000	972,00 €	1
IE-SW-VL16-14TX-2SC	14 x RJ45, 2 x SC Multi-mode	1241030000	1.059,00 €	1
IE-SW-VL16-14TX-2ST	14 x RJ45, 2 x ST Multi-mode	1241050000	1.059,00 €	1
IE-SW-VL16T-14TX-2SC	14 x RJ45, 2 x SC Multi-mode (-40 ...+75 °C)	1286610000	1.292,00 €	1
IE-SW-VL16T-14TX-2ST	14 x RJ45, 2 x ST Multi-mode (-40 ...+75 °C)	1286620000	1.292,00 €	1
Gigabit Unmanaged - Yönetilemeyen Ethernet Switchler				
* IE-SW-BL05-4GT-1GS	4 * RJ45 10/100/1000BaseT(X), 1 x combo-port	2435400000	300,00 €	1
IE-SW-VL08-8GT	8 x RJ45 10/100/1000BaseT(X)	1241270000	677,00 €	1
IE-SW-VL08T-8GT	8 x RJ45 10/100/1000BaseT(X) (-40 ...+75 °C)	1286860000	686,00 €	1
IE-SW-VL08-6GT-2GS	6 x RJ45 10/100/1000BaseT(X), 2 x combo-ports	1241280000	786,00 €	1
IE-SW-VL08T-6GT-2GS	6 x RJ45 10/100/1000BaseT(X), 2 x combo-ports (-40 ...+75 °C)	1286870000	847,00 €	1
POE Unmanaged - Yönetilemeyen Switchler				
Fast Ethernet POE				
IE-SW-BL06-2TX-4POE	2 x RJ45, 4 x RJ45 PoE	1241380000	502,00 €	1
IE-SW-BL06T-2TX-4POE	2 x RJ45, 4 x RJ45 PoE (-40 ...+75 °C)	1286920000	609,00 €	1
IE-SW-BL06-1TX-4POE-1SC	1 x RJ45, 4 x RJ45 PoE+, 1 x SC Multi-mode	1504250000	805,00 €	1
IE-SW-BL06T-1TX-4POE-1SC	1 x RJ45, 4 x RJ45 PoE+, 1 x SC Multi-mode (-40 ...+75 °C)	1504260000	933,00 €	1
IE-SW-BL06-1TX-4POE-1ST	1 x RJ45, 4 x RJ45 PoE+, 1 x ST Multi-mode	1504270000	805,00 €	1
IE-SW-BL06T-1TX-4POE-1ST	1 x RJ45, 4 x RJ45 PoE+, 1 x ST Multi-mode (-40 ...+75 °C)	1504290000	933,00 €	1
IE-SW-BL06-4POE-2SC	4 x RJ45 PoE+, 2 x SC Multi-mode	1504210000	958,00 €	1
IE-SW-BL06T-4POE-2SC	4 x RJ45 PoE+, 2 x SC Multi-mode (-40 ...+75 °C)	1504220000	1.110,00 €	1
IE-SW-BL06-4POE-2ST	4 x RJ45 PoE+, 2 x ST Multi-mode	1504230000	958,00 €	1
IE-SW-BL06T-4POE-2ST	4 x RJ45 PoE+, 2 x ST Multi-mode (-40 ...+75 °C)	1504240000	1.110,00 €	1
Gigabit POE				
IE-SW-BL05-1GT-4GTPOE	4 x RJ45 PoE+, 1 x RJ45 10/100/1000BaseT(X)	1504320000	1.062,00 €	1

Serinin devamı sayfa 93

Tip	Açıklama	Sipariş No	Fiyat/Birim	Ambalaj
IE-SW-BL05T-1GT-4GTPOE	4 x RJ45 10/100/1000BaseT(X) PoE+, 1 x RJ45 10/100/1000BaseT(X)(-40 ...+75 °C)	1504340000	1.232,00 €	1
IE-SW-BL05-1GS-4GTPOE	4 x RJ45 10/100/1000BaseT(X) PoE+, 1 x Slot 1000BaseSFP	1504360000	1.132,00 €	1
IE-SW-BL05T-1GS-4GTPOE	4 x RJ45 10/100/1000BaseT(X) PoE+, 1 x Slot 1000BaseSFP (-40 ...+75 °C)	1504380000	1.314,00 €	1
Managed - Yönetilen Ethernet Switchler				
IE-SW-VL05M-5TX	5 x RJ45	1504280000	568,00 €	1
IE-SW-VL05MT-5TX	5 x RJ45 (-40 ...+75 °C)	1504310000	625,00 €	1
IE-SW-VL08MT-8TX	8x RJ45 (-40 ...+75 °C)	1240940000	928,00 €	1
IE-SW-VL05M-3TX-2SC	3 x RJ45, 2 x SC Multi-mode	1504330000	1.025,00 €	1
IE-SW-VL05M-3TX-2ST	3 x RJ45, 2 x ST Multi-mode	1504370000	1.025,00 €	1
IE-SW-VL05MT-3TX-2SC	3 x RJ45, 2 x SC Multi-mode (-40 ...+75 °C)	1504350000	1.127,00 €	1
IE-SW-VL05MT-3TX-2ST	3 x RJ45, 2 x ST Multi-mode (-40 ...+75 °C)	1504390000	1.127,00 €	1
IE-SW-VL08MT-5TX-3SC	5 x RJ45, 3 x SC Multi-mode (-40 ...+75 °C)	1240970000	1.889,00 €	1
IE-SW-VL08MT-6TX-2ST	6 x RJ45, 2 x ST Multi-mode (-40 ...+75 °C)	1240990000	1.354,00 €	1
IE-SW-VL08MT-6TX-2SC	6 x RJ45, 2 x SC Multi-mode (-40 ...+75 °C)	1344770000	1.419,00 €	1
IE-SW-VL08MT-6TX-2SCS	6 x RJ45, 2 x SC Single-mode (-40 ...+75 °C)	1241020000	2.140,00 €	1
IE-SW-VL08MT-5TX-1SC-2SCS	5 x RJ45, 1 x SC Multi-mode, 2 x SC Single-mode (-40 ...+75 °C)	1345240000	2.122,00 €	1
IE-SW-PL08M-8TX	8 x RJ45	1241040000	1.158,00 €	1
IE-SW-PL08MT-8TX	8 x RJ45 (-40 ...+75 °C)	1286780000	1.318,00 €	1
IE-SW-PL08M-6TX-2SC	6 x RJ45, 2 x SC Multi-mode	1241070000	1.736,00 €	1
IE-SW-PL08MT-6TX-2SC	6 x RJ45, 2 x SC Multi-mode (-40 ...+75 °C)	1286790000	2.006,00 €	1
IE-SW-PL08M-6TX-2ST	6 x RJ45, 2 x ST Multi-mode	1241080000	1.736,00 €	1
IE-SW-PL08MT-6TX-2ST	6 x RJ45, 2 x ST Multi-mode (-40 ...+75 °C)	1286800000	2.006,00 €	1
IE-SW-PL08M-6TX-2SCS	6 x RJ45, 2 x SC Single-mode	1241090000	2.217,00 €	1
IE-SW-PL08MT-6TX-2SCS	6 x RJ45, 2 x SC Single-mode (-40 ...+75 °C)	1286810000	2.559,00 €	1
IE-SW-PL16M-16TX	16 x RJ45	1241100000	2.053,00 €	1
IE-SW-PL16MT-16TX	16x RJ45 (-40 ...+75 °C)	1286820000	2.370,00 €	1
IE-SW-PL16M-14TX-2SC	14 x RJ45, 2 x SC Multi-mode	1241120000	2.588,00 €	1
IE-SW-PL16MT-14TX-2SC	14 x RJ45, 2 x SC Multi-mode (-40 ...+75 °C)	1286830000	2.988,00 €	1
IE-SW-PL16M-14TX-2ST	14 x RJ45, 2 x ST Multi-mode	1241130000	2.588,00 €	1
IE-SW-PL16MT-14TX-2ST	14 x RJ45, 2 x ST Multi-mode (-40 ...+75 °C)	1286840000	2.988,00 €	1
EBR-MODULE RS232	Yedekleme modülü	1241430000	131,00 €	1
Gigabit Managed - Yönetilebilir Ethernet Switchler				
IE-SW-PL10M-3GT-7TX	3 x RJ45 10/100/1000BaseT(X) 7 x RJ45 10/100BaseT(X)	1241290000	1.813,00 €	1
IE-SW-PL10MT-3GT-7TX	3 x RJ45 10/100/1000BaseT(X) 7 x RJ45 10/100BaseT(X) (-40 ...+75 °C)	1286930000	2.097,00 €	1
IE-SW-PL10M-1GT-2GS-7TX	1 x RJ45 10/100/1000BaseT(X) 2 x Slots 1000BaseSFP, 7 x RJ45 10/100BaseT(X)	1241300000	1.813,00 €	1
IE-SW-PL10MT-1GT-2GS-7TX	1 x RJ45 10/100/1000BaseT(X) 2 x Slots 1000BaseSFP, 7 x RJ45 10/100BaseT(X) (-40 ...+75 °C)	1286940000	2.097,00 €	1
IE-SW-PL18M-2GC-16TX	16 x RJ45 10/100BaseT(X) 2 x combo-ports	1241320000	2.533,00 €	1
IE-SW-PL18MT-2GC-16TX	16 x RJ45 10/100BaseT(X) 2 x combo-ports (-40 ...+75 °C)	1286970000	2.925,00 €	1
IE-SW-PL18M-2GC14TX2SC	14 x RJ45 10/100BaseT(X) 2 x SC Multi-mode 100FX, 2 x combo-ports	1241330000	3.069,00 €	1
IE-SW-PL18MT-2GC14TX2SC	14 x RJ45 10/100BaseT(X) 2 x SC Multi-mode 100FX, 2 x combo-ports (-40 ...+75 °C)	1286990000	3.546,00 €	1
IE-SW-PL18M-2GC14TX2ST	14 x RJ45 10/100BaseT(X) 2 x ST Multi-mode, 2 x combo-ports	1241340000	3.069,00 €	1

Serinin devamı sayfa 94



IE-SW-VL05M-5TX



IE-SW-PL08M-8TX



IE-SW-PL16M-16TX



IE-SW-PL10M-3GT-7TX



IE-SW-PL10M-1GT-2GS-7TX



IE-SW-PI 09M-5GC-4GT



IE-SFP-1GSXLC



IE-SW-PI 06M-2TX-4PDE



IE-MCT-1RS232/485-1SC



IE-GW-MB-2TX-1RS232/485



IE-SR-6GT-LTE/4G-EU



IE-SR-2GT-UMTS/3G



IE-ANT-3G-806-2170-2-NF

Tip	Açıklama	Sipariş No	Fiyat/Birim	Ambalaj
IE-SW-PL18MT-2GC14TX2S-CS	14 x RJ45 10/100BaseT(X) 2 x SC Single-mode, 2 x combo-ports (-40 ...+75 °C)	1287010000	3.872,00 €	1
IE-SW-PL18M-2GC14TX2SCS	14 x RJ45 10/100BaseT(X) 2 x SC Single-mode, 2 x combo-ports	1241350000	3.352,00 €	1
IE-SW-PL18MT-2GC14TX2ST	14 x RJ45 10/100BaseT(X) 2 x ST Multi-mode, 2 x combo-ports (-40 ...+75 °C)	1287000000	3.546,00 €	1

Full Gigabit Managed - Yönetilebilir Ethernet Switchler

IE-SW-PL09M-5GC-4GT	4 x RJ45 10/100/1000BaseT(X) 5 x combo-ports	1241370000	3.330,00 €	1
IE-SW-PL09MT-5GC-4GT	4 x RJ45 10/100/1000BaseT(X) 5 x combo-ports (-40 ...+75 °C)	1287020000	2.733,00 €	1
IE-SFP-1GSXLC	Multi-mode LC konektör SFP Modülü 500m	1241490000	284,00 €	1
IE-SFP-1GLSXLC	Multi-mode LC konektör SFP Modülü 2 km	1241500000	457,00 €	1
IE-SFP-1GLXLC	Single-mode LC konektör SFP Modülü 10 km	1241510000	502,00 €	1
IE-SFP-1GLHXLC	Single-mode LC konektör SFP Modülü 40 km	1241520000	1.540,00 €	1
EBR-MODULE RS232	Yedekleme modülü	1241430000	131,00 €	1

Managed - Yönetilebilir Gigabit POE Switchler

IE-SW-PL06M-2TX-4POE	2 x RJ45, 4 x RJ45 PoE+	1241390000	1.889,00 €	1
----------------------	-------------------------	------------	------------	---

Seri / Ethernet Çevirici (COM/Server)

IE-CS-2TX-1RS232/485	2 x RJ45 ve 1 x RS232/422/485 Seri port girişi	1242080000	437,00 €	1
IE-CS-2TX-2RS232/485	2 x RJ45 ve 2 x RS232/422/485 Seri port girişi	1242090000	531,00 €	1

Seri / Fiber Çevirici

IE-MCT-1RS232/485-1SC	1 x RS232/422/485, 1 x SC multimode (-40 ...+75 °C)	1344760000	374,00 €	1
IE-MCT-1RS232/485-1ST	1 x RS232/422/485, 1 x ST multimode (-40 ...+75 °C)	1362950000	374,00 €	1

Not: Seri Port Üzerinden Haberleşen Cihazlar ile Ethernet Network Topolojileri Üzerinden Haberleşme / Watcdog timer ve Buzzer / Seri Port Ethernet ara yüzünde yüksek akımlara karşı 1kV izolasyon

Modbus TCP/Modbus Serial Gateway

IE-GW-MB-2TX-1RS232/485	2xRJ45, 1xDB9 (RS-232), 1xterminal (RS-422/485), IP 30, 0 °C...+55 °C	1504460000	577,00 €	1
IE-GWT-MB-2TX-1RS232/485	2x RJ45, 1x DB9 (RS-232), 1x terminal (RS-422/485), IP 30, -40 °C...+75 °C	1504470000	836,00 €	1

Endüstriyel Router

* IE-SR-2GT-LTE/4G-EU	Security/NAT/VPN/U-link Router, LTE / 4G modem, Gigabit Ethernet, 2x 10/100/1000BaseT(X)	2535930000	1.670,00 €	1
* IE-SR-6GT-LTE/4G-EU	Security/NAT/VPN/U-link Router, LTE / 4G modem, Gigabit Ethernet, 6x 10/100/1000BaseT(X)	2535960000	1.885,00 €	1
IE-SR-2GT-UMTS/3G	LAN / WAN 3G modem VPN router, 2 x Gigabit Ethernet	1345250000	2.132,00 €	1
* IE-SR-6GT-LAN	Security/NAT/VPN/U-link Router, Gigabit Ethernet, 6x 10/100/1000BaseT(X)	2535940000	1.550,00 €	1
IE-SR-2GT-LAN	LAN / WAN VPN router, 2 x Gigabit Ethernet	1345270000	1.580,00 €	1
IE-SR-2GT-LAN-FN	LAN / WAN router, 2 x Gigabit Ethernet	1489940000	1.279,00 €	1

Not: Yüksek Güvenlikli Firewall, 2 adet Gigabit Port (LAN / WAN), NAT maskeleyme 1:1 ağ haritalama ve port yönlendirme, VPN fonksiyonu, Entegre 3G / UMTS modem

Endüstriyel 3G Router Antenleri

IE-ANT-3G-806-2170-2-NF	25W IP 54 (- 40 to 85 °C)	1491160000	162,00 €	1
IE-ANT-0-AH-360-5-NF	100W IP 66 (- 40 to 70 °C)	1367120000	400,00 €	1
IE-CC-NM-SMAM-2M	2m Anten kablosu N-type (male) -> SMA (male)	1491180000	51,00 €	1
IE-CC-NM-SMAM-4M	4m Anten kablosu N-type (male) -> SMA (male)	1491190000	57,00 €	1
IE-CC-NM-SMAM-6M	6m Anten kablosu N-type (male) -> SMA (male)	1491210000	66,00 €	1



IE-WL-BL-AP-CL-EU



IE-ANT-O-ABG-360-7-NF



IE-SW-IP67-5M12



IE-C6FP8LD0010M40M40-D



IE-C6FP8LD0005X40X40-Y



IE-C5ES8UG0010B41B41-E

Tip	Açıklama	Sipariş No	Fiyat/Birim	Ambalaj
Wireless-Access Point/Bridge/Client				
* IE-WL-BL-AP-CL-EU	Wireless Access Point/Client, IEEE 802.11 a/b/g/n, 0 °C...60 °C	2536600000	720,00 €	1
* IE-WLT-BL-AP-CL-EU	Wireless Access Point/Client, IEEE 802.11 a/b/g/n, -40 °C...75 °C	2536650000	775,00 €	1
* IE-WL-VL-AP-BR-CL-EU	Wireless Access Point/Bridge/Client, IEEE 802.11 a/b/g/n, -25 °C...60 °C	2536680000	865,00 €	1
* IE-WLT-VL-AP-BR-CL-EU	Wireless Access Point/Bridge/Client, IEEE 802.11 a/b/g/n, -40 °C...75 °C	2536690000	990,00 €	1
IE-WLT-AP-BR-CL-ABG-EU	Wireless Access Point/Bridge/Client (-40 ...+75 °C)	1286480000	1.242,00 €	1

Not: IE 802.11 a/b/g uyumlu, Bilgi Transfer Hızı 54Mbit/s (2,4 ve 5 GHz band hızlarını desteklemektedir) / Turbo ring Roaming (50ms) ile kusursuz kablosuz bağlantı / Multi-SSID, VLAN,STP,RSTP desteği / WEP,WPA/WPA2 ve WPA2 kriptolama ile yüksek data güvenliği / POE ile uyumlu / e-mail ve röle çıkışları ile alarm oluşturma.

Kablosuz (WLAN) Uygulamalar İçin Antenler (Wireless Access Point için)

IE-ANT-O-ABG-360-7-NF	Omnidirectional 2,4 ve 5GHz, IP 68	1367130000	310,00 €	1
IE-ANT-O-AH-360-5-NF	100W IP 66 (- 40 to 70 °C)	1367120000	400,00 €	1
IE-ANT-O-BG-360-6-NF	Omnidirectional 2,4 IP 67	1367090000	385,00 €	1
IE-ANT-P-ABG-75-9-NF	Directional 2,4 ve 5GHz, IP 67	1367140000	281,00 €	1
IE-CC-NM-RPSMAM-4M	Anten kablosu N-Tip Erkek /RPSMA 4 metre	1367100000	135,00 €	1
IE-CC-NM-RPSMAM-2M	Anten kablosu N-Tip Erkek /RPSMA 2 metre	1367110000	125,00 €	1

Media Converter

IE-MC-VL-1TX-1SC	1 x RJ45, 1 x SC Multimode	1241400000	448,00 €	1
IE-MC-VL-1TX-1ST	1 x RJ45, 1 x ST Multimode	1241410000	448,00 €	1
IE-MC-VL-1TX-1SCS	1 x RJ45, 1 x SC Singlemode	1241420000	699,00 €	1

Switch IP 67

IE-SW-IP67-5M12	5 x M12 Konnektör girişi, IP 67 (-25 ...+60 °C)	1504410000	454,50 €	1
IE-SW-IP67T-5M12	5 x M12 Konnektör girişi, IP 67 (-40 ...+75 °C)	1504420000	527,00 €	1

Endüstriyel Ethernet Kabloları - Patch Kablo

Cat. 6 Patch kablo

IE-C6FP8LD0010M40M40-D	RJ45 IP20 CAT.6A / Class EA, LSZH 1m	1165940010	5,50 €	1
IE-C6FP8LD0020M40M40-D	RJ45 IP20 CAT.6A / Class EA, LSZH 2m	1165940020	7,30 €	1
IE-C6FP8LD0030M40M40-D	RJ45 IP20 CAT.6A / Class EA, LSZH 3m	1165940030	9,15 €	1
IE-C6FP8LD0040M40M40-D	RJ45 IP20 CAT.6A / Class EA, LSZH 4m	1165940040	11,60 €	1
IE-C6FP8LD0050M40M40-D	RJ45 IP20 CAT.6A / Class EA, LSZH 5m	1165940050	13,10 €	1
IE-C6FP8LD0200M40M40-D	RJ45 IP20 CAT.6A / Class EA, LSZH 20m	1165940200	41,60 €	1

Cat. 6 Crossover Patch kablo

IE-C6FP8LD0005X40X40-Y	RJ45 IP20 CAT.6A / Class EA, LSZH 0.5m	1312160005	4,80 €	1
IE-C6FP8LD0010X40X40-Y	RJ45 IP20 CAT.6A / Class EA, LSZH 1m	1312160010	5,95 €	1
IE-C6FP8LD0020X40X40-Y	RJ45 IP20 CAT.6A / Class EA, LSZH 2m	1312160020	7,70 €	1
IE-C6FP8LD0030X40X40-Y	RJ45 IP20 CAT.6A / Class EA, LSZH 3m	1312160030	9,65 €	1
IE-C6FP8LD0050X40X40-Y	RJ45 IP20 CAT.6A / Class EA, LSZH 5m	1312160050	13,50 €	1
IE-C6FP8LD0100X40X40-Y	RJ45 IP20 CAT.6A / Class EA, LSZH 10m	1312160100	23,90 €	1

Endüstriyel Ethernet Kabloları - IP 67 - 4 x 2 x AWG 26/7

IE-C5ES8UG0010B41B41-E	RJ45 IP67, V01 metal 1m	1066850000	71,00 €	1
IE-C5ES8UG0020B41B41-E	RJ45 IP67, V01 metal 2m	1066860000	75,00 €	1
IE-C5ES8UG0050B41B41-E	RJ45 IP67, V01 metal 5m	1066870000	90,50 €	1
IE-C5ES8UG0100B41B41-E	RJ45 IP67, V01 metal 10m	1066880000	118,00 €	1

Endüstriyel Ethernet Kabloları - M12 / X

M12 / M12 - 4 x 2 x AWG 22/7

IE-C5DD4UG0005MCSMCS-E	-40...70 °C - 0.5 m	1025950005	52,50 €	1
IE-C5DD4UG0015MCSMCS-E	-40...70 °C - 1.5 m	1025950015	58,00 €	1
IE-C5DD4UG0030MCSMCS-E	-40...70 °C - 3 m	1025950030	66,50 €	1
IE-C5DD4UG0050MCSMCS-E	-40...70 °C - 5 m	1025950050	77,50 €	1
IE-C5DD4UG0100MCSMCS-E	-40...70 °C - 10 m	1025950100	106,00 €	1

Serinin devamı sayfa 96



IE-C5DD4UG0010MCSA20-E



IE-C5DD4UG0015MCSXXX-X



IE-CT



PUNCH DOWN TOOL PDT



AM 12



VDATE CAT6



IE-FCM-RJ45-C



IE-PS-RJ45-FH-BK



IE-TO-RJ45-C

Tip	Açıklama	Sipariş No	Fiyat/Birim	Ambalaj
IE-C5DD4UG0015MSSMCS-E	-40...70 °C - 1.5 m	1059330015	58,00 €	1
IE-C5DD4UG0030MSSMCS-E	-40...70 °C - 3 m	1059330030	66,50 €	1
IE-C5DD4UG0050MSSMCS-E	-40...70 °C - 5 m	1059330050	77,50 €	1
IE-C5DD4UG0100MSSMCS-E	-40...70 °C - 10 m	1059330100	106,00 €	1

M12 / RJ45

IE-C5DD4UG0010MCSA20-E	-40...70 °C - 1 m	1044470010	60,00 €	1
IE-C5DD4UG0015MCSA20-E	-40...70 °C - 1.5 m	1044470015	63,50 €	1
IE-C5DD4UG0030MCSA20-E	-40...70 °C - 3 m	1044470030	71,00 €	1
IE-C5DD4UG0050MCSA20-E	-40...70 °C - 5 m	1044470050	83,00 €	1
IE-C5DD4UG0100MCSA20-E	-40...70 °C - 10 m	1044470100	110,00 €	1

M12 / Boş

IE-C5DD4UG0015MCSXXX-X	-40...70 °C - 1.5 m	1025940015	34,00 €	1
IE-C5DD4UG0030MCSXXX-X	-40...70 °C - 3 m	1025940030	41,50 €	1
IE-C5DD4UG0050MCSXXX-X	-40...70 °C - 5 m	1025940050	53,50 €	1
IE-C5DD4UG0100MCSXXX-X	-40...70 °C - 10 m	1025940100	77,50 €	1

Ethernet Kablo Test Cihazı

IE-CT	Ethernet Kablosu Test Cihazı	8808420000	2.893,00 TL	1
LAN USB TESTER	LAN ve USB bağlantıları için network kablo test aleti, LED skala/ RJ45, USB A, USB B bağlantı tipi/max 1000 mt	9205400000	888,00 TL	1

Ethernet Konnektörleri için El Aletleri

PUNCH DOWN TOOL PDT	Pach Panel Çakma	9013970000	447,10 TL	1
TT 8 RS MP 8	Sıkma	9202800000	4.513,00 TL	1
AM 12	0.5...12.5mm çap aralığına sahip UTP ve STP data kabloları için	9030060000	416,75 TL	1

Data Hatları için OVP Modülü (Parafudr)

VDATE CAT6	Data hatları için aşırı gerilim koruma modülü	1348590000	131,00 €	1
------------	---	------------	----------	---

Basic Line Switchler için Kablo Tutucu

IE-CFK-05	Basic Line 5 Port Switchler için Kablo Tutucu	1339610000	51,00 €	1
-----------	---	------------	---------	---

IE-FrontCom (IP65)

IE-FCM-RJ45-C	RJ45 Coupling (Cat.6A / Class EA)	1018790000	19,50 €	1
IE-FCM-USB-A	USB Coupling Type A	1018840000	18,50 €	1
IE-FCM-USB-AB	USB Coupling Type AB	1222550000	18,50 €	1

RJ45 Fiş (IP20) - El Aleti Gerektirmeyen Montaj

IE-PS-RJ45-FH-BK	RJ45 Fiş, Cat6a / Class EA, Profinet, TIA - 568 A/B	1963600000	19,50 €	10
IE-PS-RJ45-FH-BK-A	RJ45 Fiş, Cat6a / Class EA, TIA - 568 A	1132040000	19,50 €	10
IE-PS-RJ45-FH-BK-B	RJ45 Fiş, Cat6a / Class EA, TIA - 568 B	1132050000	19,50 €	10
IE-PS-RJ45-FH-BK-P	RJ45 Fiş, Cat6a / Class EA, Profinet	1132060000	19,50 €	10
IE-BI-RJ45-FJ-P	RJ45 Soket, Profinet	1963830000	20,00 €	1

Raya Montaj RJ45 Klemens

IE-TO-RJ45-C	RJ45 Fiş, Cat6a / Class EA, Profinet	8946920000	29,00 €	1
IE-TO-SCRJ-SM	Fiberoptik Coupling, Profinet	8947000000	33,50 €	1
IE-TO-USB	USB Coupling	8946960000	22,00 €	1

M12 Ethernet Konnektör / Fiş

SAISM-4/8S-M12 4P D-ZF	M12 Düz,Erkek 4 Kutuplu (IP67)	1892120001	32,20 €	1
SAISW-4/8S-M12 4P D-ZF	M12 Açılı,Erkek 4 Kutuplu,Yaylı Bağlantı (IP67)	1803930001	31,20 €	1
SAISM-4/8S-M12-4P D-COD	M12 Düz,Erkek 4 Kutuplu (IP67)	1892120000	18,50 €	1

M12 Ethernet Konnektör / Soket

SAIBM-4/8S-M12 4P D-ZF	M12 Düz,Dişi 4 Kutuplu,Yaylı Bağlantı (IP67)	1892130001	32,20 €	1
SAIBM-4/8S-M12-4P D-COD	M12 Düz,Dişi 4 Kutuplu (IP67)	1892130000	18,50 €	1

FrontCom® Vario Servis Arayüzleri

Sistem ve Proseslerinize güvenli erişim.

Servis durumunda USB veya Ethernet tabanlı uygulamalarınıza pano kapağını açma gereği duymaksızın erişim sağlayan FrontCom® Vario Servis Arayüzleri sayesinde servis süresini kısaltarak pano içine müdahale anlamında yetkili personel ihtiyacını ortadan kaldırmaktadır. Servis amaçlı operasyonların pano dışından ayrı konnektörler ile yapılması ile pano içi izolasyonunun, olumsuz dış ortam koşullarından etkilenmesi veya yetkisiz personel müdahalesi riskleri ortadan kalkmış olur. FrontCom® Vario modüllerinin kurulumu ve montajı oldukça pratik olup çeşitli modül kombinasyonları ile data, sinyal ve enerji girişleri gerekli ihtiyaçlar doğrultusunda tasarlanır.

- Kolay Kurulum
- IP 65 Koruma
- Güvenli Data Transferi
- Esnek Tasarım Opsiyonu





IE-FC-SFM-KNOB



IE-FC-SFP-KNOB



IE-FC-SP-PWB/2ST



IE-FC-SP-PWS/2ST/1D9



IE-BI-RJ45-FJ-A



IE-BI-USB-A



IE-FCI-D9-FM



IE-FCI-PWB-DE

Tip	Açıklama	Sipariş No	Fiyat/Birim	Ambalaj
IP 65 Koruma Kapakları				
IE-FC-SFM-KNOB	Metal hazne, butonlu ön kapak	1450530000	39,00 €	1
IE-FC-SFM-KEY	Metal hazne, kilitli ön kapak	1450540000	52,00 €	1
IE-FC-SFP-KNOB	Plastik hazne, butonlu ön kapak	1450510000	31,00 €	1
IE-FC-SFP-KEY	Plastik hazne, kilitli ön kapak	1450520000	43,50 €	1
* IE-FC-DFM-KNOB	Çiftli Metal hazne, butonlu ön kapak	2003170000	58,75 €	1
* IE-FC-DFM-KEY	Çiftli Metal hazne, kilitli ön kapak	2003180000	71,80 €	1
* IE-FC-DFM-CAB	Çiftli Metal hazne, kabin kilitli ön kapak	2003190000	58,75 €	1
* IE-FC-DFM-CAB-DB	Çiftli Metal hazne, kabin kilitli ön kapak (Daimler)	2003150000	58,75 €	1
IP 20 İç Montaj Plakaları				
IE-FC-SP-PWB/2ST	1x Enerji, 2x Data, izoleli, shielding	1450550000	27,00 €	1
IE-FC-IP-PWB/2ST	1x Enerji, 2x Data, izolesiz	1450630000	12,00 €	1
IE-FC-SP-PWS/2ST/1D9	1x Enerji, 2x Data, 1x Sinyal, izoleli, shielding	1450600000	27,50 €	1
IE-FC-IP-PWS/2ST/1D9	1x Enerji, 2x Data, 1x Sinyal, izolesiz	1450690000	12,10 €	1
IE-FC-SP-PWS/4ST	1x Enerji, 4x Data, izoleli, shielding	1450570000	27,50 €	1
IE-FC-IP-PWS/4ST	1x Enerji, 4x Data, izolesiz	1450640000	12,10 €	1
IE-FC-SP-PWS/2D9	1x Enerji, 2x Sinyal, izoleli, shielding	1450610000	27,50 €	1
IE-FC-IP-PWS/2D9	1x Enerji, 2x Sinyal, izolesiz	1450680000	12,10 €	1
IE-FC-SP-PWU/2ST	1x Enerji, 2x Data, izoleli, shielding	1450620000	27,50 €	1
IE-FC-IP-PWU/2ST	1x Enerji, 2x Data, izolesiz	1450700000	12,10 €	1
IE-FC-SP-2ST/2D9	2x Data, 2x Sinyal, izoleli, shielding	1450590000	27,50 €	1
IE-FC-IP-2ST/2D9	2x Data, 2x Sinyal, izolesiz	1450670000	12,10 €	1
IE-FC-SP-1ST/1D9/1D25	1x Data, 2x Sinyal, izoleli, shielding	1450580000	27,50 €	1
IE-FC-IP-1ST/1D9/1D25	1x Data, 2x Sinyal, izolesiz	1450650000	12,10 €	1
IP 20 Double İç Montaj Plakaları				
* IE-FC-DSP-CI/3A/2ST/1D9	1x GFCl, 1x Sigorta, 2x Data, 1x Sinyal, izoleli	2004810000	76,50 €	1
* IE-FC-DIP-CI/3A/2ST/1D9	1x GFCl, 1x Sigorta, 2x Data, 1x Sinyal, izolesiz	2003370000	60,85 €	1
* IE-FC-DSP-PWB/2ST/FILS	1x Güç, 2x Data, 1x LS Switch, izoleli	2067080000	33,65 €	1
* IE-FC-DIP-PWB/2ST/FILS	1x Güç, 2x Data, 1x LS Switch, izolesiz	2067070000	18,05 €	1
* IE-FC-DIP-BP	İzolesiz plaka	2004890000	16,60 €	1
RJ 45 Modülleri				
IE-BI-RJ45-FJ-A	TIA-A. Cat. 6A	1962850000	19,50 €	10
IE-BI-RJ45-FJ-B	TIA-B. Cat. 6A	1963840000	19,50 €	10
IE-BI-RJ45-FJ-P	RJ45 Soket, Profinet	1963830000	20,00 €	1
IE-BI-RJ45-C	Çift taraflı RJ45 dişi soket	1962840000	15,50 €	1
USB Modülleri				
IE-BI-USB-A	USB A/A 2.0	1019570000	13,10 €	10
IE-BI-USB-3.0-A	USB A/A 3.0	1487920000	17,50 €	1
IE-BI-USB-AB	USB A/B 2.0	1131380000	10,80 €	1
D-Sub Modülleri				
9-Pole				
IE-FCI-D9-FF	Dişi - Dişi	1450840000	5,50 €	1
IE-FCI-D9-FM	Dişi - Erkek	1450850000	5,50 €	1
IE-FCI-D9-FS	Dişi - Lehim Bağlantısı	1450870000	4,80 €	1
25-Pole				
IE-FCI-D25-FF	Dişi - Dişi	1450880000	7,20 €	1
IE-FCI-D25-FM	Dişi - Erkek	1450890000	7,20 €	1
IE-FCI-D25-FS	Dişi - Lehim Bağlantısı	1450900000	6,40 €	1
Priz				
IE-FCI-PWB-DE	IP 20 250V 16 A, Alman Standartı	1450730000	17,50 €	1
IE-FCI-PWB-GB	IP 20 250V 16 A, Fransız Standardı	1450770000	19,00 €	1
IE-FCI-PWB-RCBO	230V AC 16A	1534250000	132,50 €	1

Term Serisi Röleler

Geliştirilmiş mekanik ve elektronik fonksiyonları ile ray üzerinde simetrik ve her katı köpülenebilir şekilde kullanabileceğiniz Term serisi röleler panolarınızın güvenlik ve kalitesini bir üst sınıfa taşımaktadır. Ayırıcı mekanizma aynı zamanda geniş ve görsel algılamayı kolaylaştıracak şekilde LED gösterge olarak tasarlanmış olup kontak bilgisini rahatça okumanızı sağlar. Aynı taban üzerinde hem mekanik hem de optokuplör röle kullanımı mümkündür.

- Tek veya çift kontak yapısı
- Simetrik tasarım ve yuvarlatılmış keskin köşeler
- Geniş LED gösterge
- Universal giriş gerilimi (24...230 V AC/ DC)
- Anlaşılır markalama
- Her katı tarak köprü ile köpülenebilir yapı
- Montaj kolaylığı için ray üzerinde yüksek duruş

Rider Serisi

Weidmüller'in yüksek performans gerektiren uygulamalar için push-in bağlantı teknolojisi ile donattığı bu yeni RCI serisi vidalı bağlantıya göre %75 zaman tasarrufu sağlar. Ayrıca vida bağlantılı olarak da temin edilebilir.

- Sağlam : Endüstriyel tip kalın pinler
- Güvenli : Diyot korumalı LED
- Pratik : Mekanik kontakların testi için test butonu
- Hızlı : Push-In soketler
- Kolay : ZQV vidasız üst köprüler
- Komple veya ayrı ayrı sipariş edilebilme imkanı





RCL314024



SRC 2CO



RCI314024



SRC-I 2CO

Tip	Giriş	Çıkış	Sipariş No	Fiyat/Birim	Ambalaj
RCL Tip Röleler					
1 Kutuplu Enversör Kontakt 16 A, 250V					
RCL314024	24 VDC / 16,7 mA	250 V / 16 A, 1CO	8693260000	19,10 TL	20
RCL314524	24 VAC / 31,6 mA	250 V / 16 A, 1CO	8693500000	22,20 TL	20
RCL314615	115 VAC / 6,6 mA	250 V / 16 A, 1CO	8693890000	33,55 TL	20
RCL314730	230 VAC / 3,2 mA	250 V / 16 A, 1CO	8693320000	44,00 TL	20
2 Kutuplu Enversör Kontakt 2x8 A, 250 V					
RCL424024	24 VDC / 16,7 mA DC	250 V / 2x8 A, 2CO	4058570000	19,90 TL	20
RCL424524	24 VAC / 31,6 mA AC	250 V / 2x8 A, 2CO	4058600000	25,60 TL	20
RCL424615	115 VAC / 6,6 mA AC	250 V / 2x8 A, 2CO	4058610000	40,95 TL	20
RCL424730	230 VAC / 3,2 mA AC	250 V / 2x8 A, 2CO	4058630000	39,60 TL	20
RCL Röle Soketleri					
SRC 2CO	RCL Vida Bağlantılı Röle Soketi		8690830000	30,05 TL	10
SRC CLIP LP	Plastik Klips		8691090000	3,15 TL	10
RCL Röle LED ve Diyot Modülleri					
RIM 2 6/24VDC	Diyotlu LED Modülü		8690950000	18,15 TL	10
RIM 3 6/24VUC	LED Modülü		8691010000	21,45 TL	10
RIM 3 110/230VUC	LED Modülü		8691030000	21,45 TL	10
RIM 4 110/230VUC	Varistörlü LED Modülü		8691060000	30,80 TL	10
Not: RCL tipi röle gruplarında; röle, soket, LED ve koruma aksesuarları ayrı ayrı mevcuttur.					
RCI Tip Röleler					
1 Kutuplu Enversör Kontakt 16 A, 250V					
RCI314024	24 VDC / 16,7 mA	250 V / 16 A, 1CO	8869810000	28,80 TL	10
RCI314AC4	24 VDC / 16,7 mA, LED+Diyod	250 V / 16 A, 1CO	8870100000	39,00 TL	10
RCI314524	24 VAC / 31,6 mA	250 V / 16 A, 1CO	8869840000	26,05 TL	10
RCI314R24	24 VAC / 31,6 mA, LED	250 V / 16 A, 1CO	8870130000	39,15 TL	10
RCI314615	115 VAC / 6,6 mA	250 V / 16 A, 1CO	8869850000	35,90 TL	10
RCI314S15	115 VAC / 6,6 mA, LED	250 V / 16 A, 1CO	8870140000	47,05 TL	10
RCI314730	230 VAC / 3,2 mA	250 V / 16 A, 1CO	8869860000	39,60 TL	10
RCI314T30	230 VAC / 3,2 mA, LED	250 V / 16 A, 1CO	8870150000	84,00 TL	10
2 Kutuplu Enversör Kontakt 2x8 A, 250 V					
RCI424024	24 VDC / 16,7 mA	250 V / 2x8 A, 2CO	8869890000	24,25 TL	10
RCI424AC4	24 VDC / 16,7 mA, LED+Diyod	250 V / 2x8 A, 2CO	8870180000	36,40 TL	10
RCI424524	24 VAC / 31,6 mA	250 V / 2x8 A, 2CO	8869920000	27,45 TL	10
RCI424R24	24 VAC / 31,6 mA, LED	250 V / 2x8 A, 2CO	8870210000	36,40 TL	10
RCI424615	115 VAC / 6,6 mA	250 V / 2x8 A, 2CO	8869930000	53,00 TL	10
RCI424S15	115 VAC / 6,6 mA, LED	250 V / 2x8 A, 2CO	8870220000	69,00 TL	10
RCI424730	230 VAC / 3,2 mA	250 V / 2x8 A, 2CO	8869940000	54,00 TL	10
RCI484T30	230 VAC / 3,2 mA, LED+Test Butonu	250 V / 2x8 A, 2CO	8870370000	65,00 TL	10
Not: RCI Röleler Endüstriyel uygulamalar için kalın pinli olarak tasarlanmıştır. Opsiyonel olarak test soketli ve LED'li olarak seçilebilir.					
RCI Röle Soketleri					
SRC-I 2CO	RCI Vida Bağlantılı Röle Soketi		8869490000	27,45 TL	10
SRC-I 2CO P	RCI Push In Bağlantılı Röle Soketi		8869500000	41,45 TL	10
SRC-I CLIP HP	Klips		8869510000	2,85 TL	10
RCI LED ve Diyot Modülleri					
RIM-I 2 6/24VDC	Diyotlu LED Modülü		8869590000	23,75 TL	10
RIM-I 3 6/24VUC	LED Modülü		8869630000	37,00 TL	10
RIM-I 3 110/230VUC	LED Modülü		8869650000	39,00 TL	10
SRC-I QV P	Üst Köprü		8870840000	12,00 TL	10
Not: RCI tip röleler ile ayrıca Push In bağlantılı soketler kullanılabilir. Klips, LED ve koruma aksesuarları opsiyoneldir. Yanyana kullanılan röleler SRC-I QV ile köprülenebilir.					



RCM270024

Tip	Giriş	Çıkış	Sipariş No	Fiyat/Birim	Ambalaj
RCM Tip Minyatür Endüstriyel Röleler					
2 Kutuplu Enversör Kontak 2x12 A, 250 V					
RCM270024	24 VDC / 31,3 mA	250 V / 2x12 A, 2CO	8689860000	44,70 TL	10
RCM270AC4	24 VDC / 31,3 mA, LED+Diyot	250 V / 2x12 A, 2CO	8957030000	58,25 TL	10
RCM270524	24 VAC / 41,6 mA	250 V / 2x12 A, 2CO	8689760000	47,50 TL	10
RCM270R24	24 VAC / 41,6 mA, LED	250 V / 2x12 A, 2CO	8689770000	77,35 TL	10
RCM270615	115 VAC / 8,8 mA	250 V / 2x12 A, 2CO	8689800000	75,85 TL	10
RCM270S15	115 VAC / 8,8 mA, LED	250 V / 2x12 A, 2CO	8689810000	68,05 TL	10
RCM270730	230 VAC / 4,3 mA	250 V / 2x12 A, 2CO	8689820000	49,80 TL	10
RCM270T30	230 VAC / 4,3 mA, LED	250 V / 2x12 A, 2CO	8689830000	85,20 TL	10
3 Kutuplu Enversör Kontak 3x10 A, 250V					
RCM370024	24 VDC / 31,3 mA	250 V / 3x10 A, 3CO	8690040000	47,50 TL	10
RCM370AC4	24 VDC / 31,3 mA, LED+Diyot	250 V / 3x10 A, 3CO	8957100000	61,50 TL	10
RCM370524	24 VAC / 41,6 mA	250 V / 3x10 A, 3CO	8690030000	47,50 TL	10
RCM370R24	24 VAC / 41,6 mA, LED	250 V / 3x10 A, 3CO	8689950000	82,90 TL	10
RCM370615	115 VAC / 8,8 mA	250 V / 3x10 A, 3CO	8689980000	79,65 TL	10
RCM370S15	115 VAC / 8,8 mA, LED	250 V / 3x10 A, 3CO	8689990000	97,35 TL	10
RCM370730	230 VAC / 4,3 mA	250 V / 3x10 A, 3CO	8690000000	50,30 TL	10
RCM370T30	230 VAC / 4,3 Ma, LED	250 V / 3x10 A, 3CO	8690010000	139,00 TL	10
4 Kutuplu Enversör Kontak 4x6 A, 250 V					
RCM570024	24 VDC / 31,3 mA	250 V / 4x6 A, 4CO	8690200000	47,50 TL	10
RCM570AC4	24 VDC / 31,3 mA, LED+Diyot	250 V / 4x6 A, 4CO	8957170000	61,50 TL	10
RCM570524	24 VAC / 41,6 mA	250 V / 4x6 A, 4CO	8690110000	53,00 TL	10
RCM570R24	24 VAC / 41,6 mA, LED	250 V / 4x6 A, 4CO	8690120000	71,30 TL	10
RCM570615	115 VAC / 8,8 mA	250 V / 4x6 A, 4CO	1180800000	61,50 TL	10
RCM570S15	115 VAC / 8,8 mA, LED	250 V / 4x6 A, 4CO	8690150000	95,50 TL	10
RCM570730	230 VAC / 4,3 mA	250 V / 4x6 A, 4CO	1181100000	47,50 TL	10
RCM570T30	230 VAC / 4,3 mA, LED	250 V / 4x6 A, 4CO	8690160000	61,50 TL	10
RCM Röle Soket ve Klipsleri					
SCM 2CO	2 Kutuplu Vida Bağlantılı Röle Soketi		8690880000	31,65 TL	10
SCM 3CO	3 Kutuplu Vida Bağlantılı Röle Soketi		8690890000	30,80 TL	10
SCM 4CO	4 Kutuplu Vida Bağlantılı Röle Soketi		8690900000	35,25 TL	10
SCM CLIP P	Plastik Klips (Vidalı bağlantı için)		8691110000	3,40 TL	10
SCM-I 2CO P	2 Kutuplu Push In Bağlantılı Röle Soketi		8876220000	69,00 TL	10
SCM-I 4CO P	4 Kutuplu Push In Bağlantılı Röle Soketi		8869430000	75,00 TL	10
SCM-I CLIP P	Plastik Klips (Push In için)		8869440000	3,25 TL	10
RCM Röle LED ve Diyet Modülleri					
RIM 2 6/24VDC	Diyotlu LED Modülü		8690950000	18,15 TL	10
RIM 3 6/24VUC	LED Modülü		8691010000	21,45 TL	10
RIM 3 110/230VUC	LED Modülü		8691030000	21,45 TL	10
RIM 4 6/24VUC	Varistörlü LED Modülü (Vidalı bağlantı için)		8691040000	28,40 TL	10
RIM 4 110/230VUC	Varistörlü LED Modülü		8691060000	30,80 TL	10
RIM-I 2 6/24VDC	Diyotlu LED Modülü		8869590000	23,75 TL	10
RIM-I 3 6/24VUC	LED Modülü		8869630000	37,00 TL	10
RIM-I 3 110/230VUC	LED Modülü		8869650000	39,00 TL	10
SCM-I QV P	2 Kutuplu Üst Köprü (Push In için)		8870850000	5,60 TL	10
Not: RCM tipi minyatür röleler için vidalı ve Push In soketler, ledler, koruma devreleri ve üst köprüler.					



SCM 4CO



RCIKIT 24VDC 1CO LD



RCMKIT-1 24VDC 3CO LD



DRI314012



DRI314012L



DRI314012LD

Tip	Giriş	Çıkış	Sipariş No	Fiyat/Birim	Ambalaj
Endüstriyel Tip Röle Kitleri					
RCI TİP RÖLELER, 1 Kutuplu Enversör Kontak 16 A, 250 V					
RCIKIT 24VDC 1CO LD	24 VDC / 16,7 mA, LED+Diyod	250 V / 16 A, 1CO	8871000000	91,80 TL	10
RCIKIT 24VAC 1CO LD	24 VAC / 31,6 mA, LED	250 V / 16 A, 1CO	8871010000	90,80 TL	10
RCIKIT 115VAC 1CO LD	115 VAC / 6,6 mA, LED	250 V / 16 A, 1CO	8897090000	98,75 TL	10
RCIKIT 230VAC 1CO LD	230 VAC / 3,2 mA, LED	250 V / 16 A, 1CO	8871020000	139,00 TL	10
RCI TİP RÖLELER, 2 Kutuplu Enversör Kontak 2x8 A, 250 V					
RCIKIT 24VDC 2CO LD	24 VDC / 16,7 mA, LED+Diyod	250 V / 2x8 A, 2CO	8871030000	94,50 TL	10
RCIKIT 24VAC 2CO LD	24 VAC / 31,6 mA, LED	250 V / 2x8 A, 2CO	8871040000	124,00 TL	10
RCIKIT 115VAC 2CO LD	115 VAC / 6,6 mA, LED	250 V / 2x8 A, 2CO	8897100000	100,60 TL	10
RCIKIT 230VAC 2CO LD	230 VAC / 3,2 mA, LED	250 V / 2x8 A, 2CO	8871050000	117,85 TL	10
RCM TİP MİNYATÜR ENDÜSTRİYEL RÖLELER, 2 Kutuplu Enversör Kontak 2x12 A, 250 V					
RCMKIT-1 24VDC 2CO LD	24 VDC / 31,3 mA, LED	250 V / 2x12 A, 2CO	8920940000	151,80 TL	10
RCMKIT-1 24VAC 2CO LD	24 VAC / 41,6 mA, LED	250 V / 2x12 A, 2CO	8920950000	151,80 TL	10
RCMKIT-1 115VAC 2CO LD	115 VAC / 8,8 mA, LED	250 V / 2x12 A, 2CO	8920960000	167,20 TL	10
RCMKIT-1 230VAC 2CO LD	230 VAC / 4,3 mA, LED	250 V / 2x12 A, 2CO	8920970000	159,30 TL	10
RCM TİP MİNYATÜR ENDÜSTRİYEL RÖLELER, 3 Kutuplu Enversör Kontak 3x10 A, 250 V					
RCMKIT-1 24VDC 3CO LD	24 VDC / 31,3 mA, LED	250 V / 3x10 A, 3CO	8920980000	199,00 TL	10
RCMKIT-1 24VAC 3CO LD	24 VAC / 41,6 mA, LED	250 V / 3x10 A, 3CO	8920990000	158,85 TL	10
RCMKIT-1 115VAC 3CO LD	115 VAC / 8,8 mA, LED	250 V / 3x10 A, 3CO	8921010000	115,50 TL	10
RCMKIT-1 230VAC 3CO LD	230 VAC / 4,3 mA, LED	250 V / 3x10 A, 3CO	8921020000	168,15 TL	10
RCM TİP MİNYATÜR ENDÜSTRİYEL RÖLELER, 4 Kutuplu Enversör Kontak 4x6 A, 250 V					
RCMKIT-1 24VDC 4CO LD	24 VDC / 31,3 mA, LED	250 V / 4x6 A, 4CO	8921030000	160,70 TL	10
RCMKIT-1 24VAC 4CO LD	24 VAC / 41,6 mA, LED	250 V / 4x6 A, 4CO	8921040000	160,70 TL	10
RCMKIT-1 115VAC 4CO LD	115 VAC / 8,8 mA, LED	250 V / 4x6 A, 4CO	8921050000	152,75 TL	10
RCMKIT-1 230VAC 4CO LD	230 VAC / 4,3 mA, LED	250 V / 4x6 A, 4CO	8921060000	158,35 TL	10
DRI Serisi Röleler					
1CO Kontak, 10 A / 250 V AC					
Röle					
DRI314012	12 VDC / 44,4 mA	250 V / 10 A, 1CO	7760056296	24,70 TL	20
DRI314024	24 VDC / 21,8 mA	250 V / 10 A, 1CO	7760056297	24,70 TL	20
DRI314048	48 VDC / 11,2 mA	250 V / 10 A, 1CO	7760056298	27,05 TL	20
DRI314110	110 VDC / 4,8 mA	250 V / 10 A, 1CO	7760056299	30,30 TL	20
DRI314524	24 VAC / 50 mA	250 V / 10 A, 1CO	7760056300	32,65 TL	20
DRI314615	115 VAC / 9,3 mA	250 V / 10 A, 1CO	7760056301	32,65 TL	20
DRI314730	230 VAC / 4,9 mA	250 V / 10 A, 1CO	7760056302	32,65 TL	20
Röle + LED					
DRI314012L	12 VDC / 44,4 mA, LED	250 V / 10 A, 1CO	7760056303	28,80 TL	20
DRI314024L	24 VDC / 21,8 mA, LED	250 V / 10 A, 1CO	7760056304	28,80 TL	20
DRI314048L	48 VDC / 11,2 mA, LED	250 V / 10 A, 1CO	7760056305	31,20 TL	20
DRI314110L	110 VDC / 4,8 mA, LED	250 V / 10 A, 1CO	7760056306	34,00 TL	20
DRI314524L	24 VAC / 44,4 mA, LED	250 V / 10 A, 1CO	7760056307	36,40 TL	20
DRI314615L	115 VAC / 44,4 mA, LED	250 V / 10 A, 1CO	7760056308	36,40 TL	20
DRI314730L	230 VAC / 44,4 mA, LED	250 V / 10 A, 1CO	7760056309	36,40 TL	20
Röle + LED + Diyot					
DRI314012LD	12 VDC / 44,4 mA, LED + Diyot	250 V / 10 A, 1CO	7760056310	28,80 TL	20
DRI314024LD	24 VDC / 21,8 mA, LED + Diyot	250 V / 10 A, 1CO	7760056311	28,80 TL	20
DRI314048LD	48 VDC / 11,2 mA, LED + Diyot	250 V / 10 A, 1CO	7760056312	31,20 TL	20
DRI314110LD	110 VDC / 4,8 mA, LED + Diyot	250 V / 10 A, 1CO	7760056313	34,00 TL	20



DRI314524LT



DRI314012LTD



DRI424012



DRI424012L



DRI424524LT



DRI424012LTD



SDI 1C0

Tip	Giriş	Çıkış	Sipariş No	Fiyat/Birim	Ambalaj
Röle + LED + Test Butonu					
DRI314524LT	24 VAC / 50 mA, LED + Test	250 V / 10 A, 1CO	7760056318	40,50 TL	20
DRI314615LT	115 VAC / 9,3 mA, LED + Test	250 V / 10 A, 1CO	7760056319	40,50 TL	20
DRI314730LT	230 VAC / 4,9 mA, LED + Test	250 V / 10 A, 1CO	7760056320	40,50 TL	20
Röle + LED + Diyot + Test Butonu					
DRI314012LTD	12 VDC / 44,4 mA, LED + Diyot + Test	250 V / 10 A, 1CO	7760056314	32,65 TL	20
DRI314024LTD	24 VDC / 21,8 mA, LED + Diyot + Test	250 V / 10 A, 1CO	7760056315	32,65 TL	20
DRI314048LTD	48 VDC / 11,2 mA, LED + Diyot + Test	250 V / 10 A, 1CO	7760056316	34,90 TL	20
DRI314110LTD	110 VDC / 4,8 mA, LED + Diyot + Test	250 V / 10 A, 1CO	7760056317	38,15 TL	20
2CO Kontak, 5 A / 250 V AC					
Röle					
DRI424012	12 VDC / 44,4 mA	250 V / 2x5 A, 2CO	7760056321	27,05 TL	20
DRI424024	24 VDC / 21,8 mA	250 V / 2x5 A, 2CO	7760056322	27,05 TL	20
DRI424048	48 VDC / 11,2 mA	250 V / 2x5 A, 2CO	7760056323	28,80 TL	20
DRI424110	110 VDC / 4,8 mA	250 V / 2x5 A, 2CO	7760056324	31,65 TL	20
DRI424524	24 VAC / 50 mA	250 V / 2x5 A, 2CO	7760056325	34,00 TL	20
DRI424615	115 VAC / 9,3 mA	250 V / 2x5 A, 2CO	7760056326	34,00 TL	20
DRI424730	230 VAC / 4,9 mA	250 V / 2x5 A, 2CO	7760056327	34,00 TL	20
Röle + LED					
DRI424012L	12 VDC / 44,4 mA, LED	250 V / 2x5 A, 2CO	7760056328	32,65 TL	20
DRI424024L	24 VDC / 21,8 mA, LED	250 V / 2x5 A, 2CO	7760056329	32,65 TL	20
DRI424048L	48 VDC / 11,2 mA, LED	250 V / 2x5 A, 2CO	7760056330	34,90 TL	20
DRI424110L	110 VDC / 4,8 mA, LED	250 V / 2x5 A, 2CO	7760056331	38,15 TL	20
DRI424524L	24 VAC / 44,4 mA, LED	250 V / 2x5 A, 2CO	7760056332	40,50 TL	20
DRI424615L	115 VAC / 44,4 mA, LED	250 V / 2x5 A, 2CO	7760056333	40,50 TL	20
DRI424730L	230 VAC / 44,4 mA, LED	250 V / 2x5 A, 2CO	7760056334	40,50 TL	20
Röle + LED + Diyot					
DRI424012LD	12 VDC / 44,4 mA, LED + Diyot	250 V / 2x5 A, 2CO	7760056335	32,65 TL	20
DRI424024LD	24 VDC / 21,8 mA, LED + Diyot	250 V / 2x5 A, 2CO	7760056336	32,65 TL	20
DRI424048LD	48 VDC / 11,2 mA, LED + Diyot	250 V / 2x5 A, 2CO	7760056337	34,90 TL	20
DRI424110LD	110 VDC / 4,8 mA, LED + Diyot	250 V / 2x5 A, 2CO	7760056338	38,15 TL	20
Röle + LED + Test Butonu					
DRI424524LT	24 VAC / 50 mA, LED + Test	250 V / 2x5 A, 2CO	7760056343	44,20 TL	20
DRI424615LT	115 VAC / 9,3 mA, LED + Test	250 V / 2x5 A, 2CO	7760056344	44,20 TL	20
DRI424730LT	230 VAC / 4,9 mA, LED + Test	250 V / 2x5 A, 2CO	7760056345	44,20 TL	20
Röle + LED + Diyot + Test Butonu					
DRI424012LTD	12 VDC / 44,4 mA, LED + Diyot + Test	250 V / 2x5 A, 2CO	7760056339	36,40 TL	20
DRI424024LTD	24 VDC / 21,8 mA, LED + Diyot + Test	250 V / 2x5 A, 2CO	7760056340	36,40 TL	20
DRI424048LTD	48 VDC / 11,2 mA, LED + Diyot + Test	250 V / 2x5 A, 2CO	7760056341	38,60 TL	20
DRI424110LTD	110 VDC / 4,8 mA, LED + Diyot + Test	250 V / 2x5 A, 2CO	7760056342	42,00 TL	20
DRI Tip Röle Soket ve Klips					
Röle + LED + Diyot + Test Butonu					
SDI 1CO	DRI Vida Bağlantılı 1CO Röle Soketi		7760056350	20,00 TL	10
SDI 2CO	DRI Vida Bağlantılı 2CO Röle Soketi		7760056351	21,45 TL	10
* SDI 1CO P	Push-in bağlantılı 1CO Röle Soketi		7760056364	35,00 TL	20
* SDI 2CO P	Push-in bağlantılı 2CO Röle Soketi		7760056365	36,00 TL	20
SDI CLIP	Plastik Klip		7760056352	2,35 TL	10



DRM270012



DRM570012



FS 2CO

Tip	Giriş	Çıkış	Sipariş No	Fiyat/Birim	Ambalaj
DRM Serisi Röleler					
2 CO Kontakt, 10 A / 250 V AC					
DRM270012	12VDC/75mA	10 A / 250 V AC, 2 CO	7760056050	28,80 TL	20
DRM270024	24VDC/36,8mA	10 A / 250 V AC, 2 CO	7760056051	28,80 TL	20
DRM270048	48VDC/18,5mA	10 A / 250 V AC, 2 CO	7760056052	30,05 TL	20
DRM270110	110VDC/10mA	10 A / 250 V AC, 2 CO	7760056053	31,65 TL	20
DRM270220	220VDC/5,2mA	10 A / 250 V AC, 2 CO	7760056054	40,95 TL	20
DRM270524	24VAC/62,4mA @50Hz	10 A / 250 V AC, 2 CO	7760056055	30,05 TL	20
DRM270548	48VAC/33,3mA @50Hz	10 A / 250 V AC, 2 CO	7760056056	30,05 TL	20
DRM270615	115VAC/12,6mA @50Hz	10 A / 250 V AC, 2 CO	7760056057	30,05 TL	20
DRM270730	230VAC/6,1mA @50Hz	10 A / 250 V AC, 2 CO	7760056058	31,65 TL	20
DRM270012L	12VDC +LED/75mA	10 A / 250 V AC, 2 CO	7760056059	30,80 TL	20
DRM270024L	24VDC+LED/36,8mA	10 A / 250 V AC, 2 CO	7760056060	30,80 TL	20
DRM270048L	48VDC+LED/18,5mA	10 A / 250 V AC, 2 CO	7760056061	32,15 TL	20
DRM270110L	110VDC+LED/10mA	10 A / 250 V AC, 2 CO	7760056062	34,00 TL	20
DRM270220L	220VDC+LED/5,2mA	10 A / 250 V AC, 2 CO	7760056063	43,35 TL	20
DRM270524L	24VAC+LED/62,4mA @50Hz	10 A / 250 V AC, 2 CO	7760056064	32,80 TL	20
DRM270548L	48VAC+LED/33,3mA @50Hz	10 A / 250 V AC, 2 CO	7760056065	32,80 TL	20
DRM270615L	115VAC+LED/12,6mA @50Hz	10 A / 250 V AC, 2 CO	7760056066	32,80 TL	20
DRM270730L	230VAC+LED/6,1mA @50Hz	10 A / 250 V AC, 2 CO	7760056067	34,00 TL	20
4 CO Kontakt, 5 A / 250 V AC					
DRM570012	12VDC/75mA	5 A / 250 V AC, 4 CO	7760056078	30,80 TL	20
DRM570024	24VDC/36,8mA	5 A / 250 V AC, 4 CO	7760056079	30,80 TL	20
DRM570048	48VDC/18,5mA	5 A / 250 V AC, 4 CO	7760056080	31,65 TL	20
DRM570110	110VDC/10mA	5 A / 250 V AC, 4 CO	7760056081	33,55 TL	20
DRM570220	220VDC/5,2mA	5 A / 250 V AC, 4 CO	7760056082	43,35 TL	20
DRM570524	24VAC/62,4mA @50Hz	5 A / 250 V AC, 4 CO	7760056083	31,65 TL	20
DRM570548	48VAC/33,3mA @50Hz	5 A / 250 V AC, 4 CO	7760056084	31,65 TL	20
DRM570615	115VAC/12,6mA @50Hz	5 A / 250 V AC, 4 CO	7760056085	31,65 TL	20
DRM570730	230VAC/6,1mA @50Hz	5 A / 250 V AC, 4 CO	7760056086	33,55 TL	20
DRM570012L	12VDC +LED/75mA	5 A / 250 V AC, 4 CO	7760056087	32,80 TL	20
DRM570024L	24VDC+LED/36,8mA	5 A / 250 V AC, 4 CO	7760056088	32,80 TL	20
DRM570048L	48VDC+LED/18,5mA	5 A / 250 V AC, 4 CO	7760056089	34,00 TL	20
DRM570110L	110VDC+LED/10mA	5 A / 250 V AC, 4 CO	7760056090	35,90 TL	20
DRM570220L	220VDC+LED/5,2mA	5 A / 250 V AC, 4 CO	7760056091	45,25 TL	20
DRM570524L	24VAC+LED/62,4mA @50Hz	5 A / 250 V AC, 4 CO	7760056092	34,40 TL	20
DRM570548L	48VAC+LED/33,3mA @50Hz	5 A / 250 V AC, 4 CO	7760056093	34,40 TL	20
DRM570615L	115VAC+LED/12,6mA @50Hz	5 A / 250 V AC, 4 CO	7760056094	34,40 TL	20
DRM570730L	230VAC+LED/6,1mA @50Hz	5 A / 250 V AC, 4 CO	7760056095	39,00 TL	20
<ul style="list-style-type: none"> • Yüksek anahtarlama gücüne sahip kompakt yapı. • Geniş bobin giriş voltaj aralığı. • Opsiyonel test butonu (AC kırmızı, DC mavi). • Opsiyonel durum LEDi (AC kırmızı, DC yeşil). • Opsiyonel diyot koruması 					
DRM Tip Röle Soket ve Klipsleri					
FS 2CO	2 kontak röle soketi		7760056106	17,00 TL	10
FS 4CO	4 kontak röle soketi		7760056107	21,45 TL	10
* SCM 2CO P	2 kontak röle soketi Push-in		7760056362	57,75 TL	10
* SCM 4CO P	4 kontak röle soketi Push-in		7760056363	62,50 TL	10
DRM/DRL CLIP M	Metal Klip		7760056108	0,894 TL	10
DRM Tip Röle LED ve Koruma Modülleri					
RIM 1 6/230VDC	Diyot Koruması 6...230 V DC		7760056169	5,60 TL	10
RIM 3 110/230VAC	RC filtre koruması 110...230 V AC		7760056014	17,00 TL	10
RIM 3 110/230VAC LED	RC filtre koruması 110...230 V AC LED ile birlikte		7760056045	17,00 TL	10

Serinin devamı sayfa 105

Tip	Giriş	Çıkış	Sipariş No	Fiyat/Birim	Ambalaj
RIM 2 6/24VDC	Yeşil LED 6...24 V DC diyot korumalı		7760056015	11,20 TL	10
RIM 2 24/60VDC	Yeşil LED 24...60 V DC diyot korumalı		7760056016	11,20 TL	10
RIM 2 110/230VDC	Yeşil LED 110...230 V DC diyot korumalı		7760056017	11,20 TL	10
RIM 3 6/24VUC	Yeşil LED 6...24 V DC / V AC		7940018457	11,20 TL	20
RIM 3 24/60VUC	Yeşil LED 24...60 V DC / V AC		7760056018	11,20 TL	10
RIM 3 110/230VUC	Yeşil LED 110...230 V DC / V AC		7940018455	11,20 TL	20

DRL Güç Röleleri**1 CO Kontak, 16 A / 250 V AC**

DRL170012L	12VDC/75mA	16 A/250VAC, 1CO	1133450000	83,85 TL	20
DRL170024L	24VDC/36,8mA	16 A/250VAC, 1CO	1133460000	83,85 TL	20
DRL170048L	48VDC/18,5mA	16 A/250VAC, 1CO	1133470000	91,80 TL	20
DRL170110L	110VDC/10mA	16 A/250VAC, 1CO	1133480000	100,60 TL	20
DRL170220L	220VDC/5,2mA	16 A/250VAC, 1CO	1133490000	100,60 TL	20
DRL170524L	24VAC/54mA	16 A/250VAC, 1CO	1133840000	91,80 TL	20
DRL170615L	115VAC/12,9mA	16 A/250VAC, 1CO	1133850000	100,60 TL	20
DRL170730L	230VAC/6,8mA	16 A/250VAC, 1CO	1133860000	100,60 TL	20

2 CO Kontak, 10 A / 250 V AC

DRL270012L	12VDC/75mA	10 A/250VAC, 2CO	1133510000	100,60 TL	20
DRL270024L	24VDC/36,8mA	10 A/250VAC, 2CO	1133520000	100,60 TL	20
DRL270048L	48VDC/18,5mA	10 A/250VAC, 2CO	1133530000	109,00 TL	20
DRL270110L	110VDC/10mA	10 A/250VAC, 2CO	1133540000	117,40 TL	20
DRL270220L	220VDC/5,2mA	10 A/250VAC, 2CO	1133550000	116,90 TL	20
DRL270524L	24VAC/54mA	10 A/250VAC, 2CO	1133870000	109,00 TL	20
DRL270615L	115VAC/12,9mA	10 A/250VAC, 2CO	1133880000	116,90 TL	20
DRL270730L	230VAC/6,8mA	10 A/250VAC, 2CO	1133890000	116,90 TL	20

3 CO Kontak, 10 A / 250 V AC

DRL370012L	12VDC/120mA	10 A/250VAC, 3CO	1133570000	125,30 TL	10
DRL370024L	24VDC/60mA	10 A/250VAC, 3CO	1133580000	125,30 TL	10
DRL370048L	48VDC/30mA	10 A/250VAC, 3CO	1133590000	142,10 TL	10
DRL370110L	110VDC/13,1mA	10 A/250VAC, 3CO	1133600000	150,40 TL	10
DRL370220L	220VDC/6,7mA	10 A/250VAC, 3CO	1133610000	150,40 TL	10
DRL370524L	24VAC/80mA	10 A/250VAC, 3CO	1133910000	142,10 TL	10
DRL370615L	115VAC/16mA	10 A/250VAC, 3CO	1133920000	150,40 TL	10
DRL370730L	230VAC/10mA	10 A/250VAC, 3CO	1133930000	150,40 TL	10

4 CO Kontak, 10 A / 250 V AC

DRL570012L	12VDC/125mA	10 A/250VAC, 4CO	1133620000	166,80 TL	10
DRL570024L	24VDC/66,7mA	10 A/250VAC, 4CO	1133630000	166,80 TL	10
DRL570048L	48VDC/31,2mA	10 A/250VAC, 4CO	1133640000	183,95 TL	10
DRL570110L	110VDC/16,2mA	10 A/250VAC, 4CO	1133650000	200,35 TL	10
DRL570220L	220VDC/7,6mA	10 A/250VAC, 4CO	1133660000	200,35 TL	10
DRL570524L	24VAC/93,7mA	10 A/250VAC, 4CO	1133940000	183,95 TL	10
DRL570615L	115VAC/25,5mA	10 A/250VAC, 4CO	1133950000	200,35 TL	10
DRL570730L	230VAC/13,1mA	10 A/250VAC, 4CO	1133960000	200,35 TL	10

DRL Tip Rölelerin Soket ve Klipsleri

SLD F 2CO	2 kontak vidalı tip röle soketi	7760056225	57,80 TL	10
SLD F 3CO	3 kontak vidalı tip röle soketi	7760056226	69,40 TL	10
SLD F 4CO	4 kontak vidalı tip röle soketi	7760056227	80,60 TL	10
DRM/DRL CLIP M	Metal Klips	7760056108	0,894 TL	10
SLD CLIP 3CO M	3 kontak soket Klips	7760056234	5,60 TL	10
SLD CLIP 4CO M	4 kontak soket Klips	7760056235	5,60 TL	10



DRL170012L



DRL370012L



DRL570012L



SLD F 2CO



DRW270012LT



DRW370012LT



SPW ECO 3CO

Tip	Giriş	Çıkış	Sipariş No	Fiyat/Birim	Ambalaj
DRL Tip Röle Koruma Modülü					
RIM 1 6/230VDC	Diyot Koruması 6...230 V DC		7760056169	5,60 TL	10
RIM 3 110/230VAC	RC filtre koruması 110...230 V AC		7760056014	17,00 TL	10
RIM 5 6/230VAC	4 kontak soket için RC filtre		1174670000	25,60 TL	10
RIM 5 6/230VDC	4 kontak soket için diyot		1174650000	25,60 TL	10
DRW Güç Röleleri					
2 CO Kontak, 16A / 250V AC					
DRW270012LT	12VDC/120mA	16 A/250VAC, 2CO/LEDli+ Test Butonlu	1219730000	153,20 TL	10
DRW270024LT	24VDC/60mA	16 A/250VAC, 2CO/LEDli+ Test Butonlu	1219740000	153,20 TL	10
DRW270048LT	48VDC/30mA	16 A/250VAC, 2CO/LEDli+ Test Butonlu	1219750000	161,60 TL	10
DRW270110LT	110VDC/13,03mA	16 A/250VAC, 2CO/LEDli+ Test Butonlu	1219760000	150,40 TL	10
DRW270220LT	220VDC/6,7mA	16 A/250VAC, 2CO/LEDli+ Test Butonlu	1219770000	177,95 TL	10
DRW270524LT	24VAC/101,7mA	16 A/250VAC, 2CO/LEDli+ Test Butonlu	1219350000	150,40 TL	10
DRW270548LT	48VAC/51,04mA	16 A/250VAC, 2CO/LEDli+ Test Butonlu	1219360000	150,40 TL	10
DRW270615LT	115VAC/21,2mA	16 A/250VAC, 2CO/LEDli+ Test Butonlu	1219370000	150,40 TL	10
DRW270730LT	230VAC/10,61mA	16 A/250VAC, 2CO/LEDli+ Test Butonlu	1219380000	177,95 TL	10
DRW270900LT	400VAC/6,1mA	16 A/250VAC, 2CO/LEDli+ Test Butonlu	1219390000	183,95 TL	10
3 CO Kontak, 16A / 250V AC					
DRW370012LT	12VDC/120mA	16 A/250VAC, 3CO/LEDli+ Test Butonlu	1219780000	142,10 TL	10
DRW370024LT	24VDC/60mA	16 A/250VAC, 3CO/LEDli+ Test Butonlu	1219790000	142,10 TL	10
DRW370048LT	48VDC/30mA	16 A/250VAC, 3CO/LEDli+ Test Butonlu	1219810000	150,40 TL	10
DRW370110LT	110VDC/13,03mA	16 A/250VAC, 3CO/LEDli+ Test Butonlu	1219820000	166,80 TL	10
DRW370220LT	220VDC/6,7mA	16 A/250VAC, 3CO/LEDli+ Test Butonlu	1219830000	166,80 TL	10
DRW370524LT	24VAC/101,7mA	16 A/250VAC, 3CO/LEDli+ Test Butonlu	1219410000	166,80 TL	10
DRW370548LT	48VAC/51,04mA	16 A/250VAC, 3CO/LEDli+ Test Butonlu	1219420000	166,80 TL	10
DRW370615LT	115VAC/21,2mA	16 A/250VAC, 3CO/LEDli+ Test Butonlu	1219430000	166,80 TL	10
DRW370730LT	230VAC/10,61mA	16 A/250VAC, 3CO/LEDli+ Test Butonlu	1219440000	166,80 TL	10
DRW370900LT	400VAC/6,1mA	16 A/250VAC, 3CO/LEDli+ Test Butonlu	1219450000	208,65 TL	10
DRW Tip Rölelerin Soket ve Aksesuarları					
SPW ECO 3CO	Röle soketi		1220250000	50,30 TL	10
DRW/DRH CLIP M	Metal Klips		1220260000	4,20 TL	10
RIM 5 6/230VAC	4 kontak soket için RC filtre		1174670000	25,60 TL	10
RIM 5 6/230VDC	4 kontak soket için diyot		1174650000	25,60 TL	10



DRR270012L



DRR370012L



SRD ECO 2CO



DRH173012LT



DRH174012LT



DRH275012LT

Tip	Giriş	Çıkış	Sipariş No	Fiyat/Birim	Ambalaj
DRR Güç Röleleri					
2 CO Kontakt, 10 A / 250 V AC					
DRR270012L	12VDC/125mA	10 A/250VAC, 2CO	1133360000	68,05 TL	10
DRR270024L	24VDC/55,8mA	10 A/250VAC, 2CO	1133370000	68,05 TL	10
DRR270048L	48VDC/29,3mA	10 A/250VAC, 2CO	1133380000	75,45 TL	10
DRR270110L	110VDC/14,9mA	10 A/250VAC, 2CO	1133390000	83,85 TL	10
DRR270220L	220VDC/7,5mA	10 A/250VAC, 2CO	1133400000	100,60 TL	10
DRR270524L	24VAC/130mA @50Hz	10 A/250VAC, 2CO	1133760000	67,10 TL	10
DRR270615L	115VAC/29,8mA @50Hz	10 A/250VAC, 2CO	1133780000	75,45 TL	10
DRR270730L	230VAC/14,9mA @50Hz	10 A/250VAC, 2CO	1133800000	75,45 TL	10
3 CO Kontakt, 10 A / 250 V AC					
DRR370012L	12VDC/125mA	10 A/250VAC, 3CO	1133410000	75,45 TL	10
DRR370024L	24VDC/55,8mA	10 A/250VAC, 3CO	1133420000	75,45 TL	10
DRR370048L	48VDC/29,3mA	10 A/250VAC, 3CO	1133430000	83,85 TL	10
DRR370110L	110VDC/14,9mA	10 A/250VAC, 3CO	1133440000	91,80 TL	10
DRR370220L	220VDC/7,5mA	10 A/250VAC, 3CO	1133560000	109,00 TL	10
DRR370524L	24VAC/130mA @50Hz	10 A/250VAC, 3CO	1133810000	83,85 TL	10
DRR370615L	115VAC/29,8mA @50Hz	10 A/250VAC, 3CO	1133820000	91,80 TL	10
DRR370730L	230VAC/14,9mA @50Hz	10 A/250VAC, 3CO	1133830000	91,80 TL	10
DRR Tip Rölelerin Soket ve Aksesuarları					
SRD ECO 2CO	2 kontak röle soketi		1132810000	25,60 TL	10
SRD ECO 3CO	3 kontak röle sokeri		1132820000	25,60 TL	10
DRR CLIP M	Metal Klips		1134160000	4,20 TL	10
RIM 5 6/230VAC	4 kontak soket için RC filtre		1174670000	25,60 TL	10
RIM 5 6/230VDC	4 kontak soket için diyot		1174650000	25,60 TL	10
DRH DC Röleler					
1 NO Kontakt, 16 A / 500 V AC					
DRH173012LT	12VDC/120mA	16 A/ 500VAC, 1NO	1219840000	153,20 TL	10
DRH173024LT	24VDC/60mA	16 A/ 500VAC, 1NO	1219850000	153,20 TL	10
DRH173048LT	48VDC/30mA	16 A/ 500VAC, 1NO	1219860000	161,10 TL	10
DRH173110LT	110VDC/13,03mA	16 A/ 500VAC, 1NO	1219870000	177,00 TL	10
DRH173220LT	220VDC/6,7mA	16 A/ 500VAC, 1NO	1219880000	177,00 TL	10
DRH173524LT	24VAC/101,7mA	16 A/ 500VAC, 1NO	1219890000	177,00 TL	10
DRH173548LT	48VAC/51,04mA	16 A/ 500VAC, 1NO	1219910000	177,00 TL	10
DRH173615LT	115VAC/21,2mA	16 A/ 500VAC, 1NO	1219920000	177,00 TL	10
DRH173730LT	230VAC/10,61mA	16 A/ 500VAC, 1NO	1219930000	177,00 TL	10
1 NC Kontakt, 16 A / 500 V AC					
DRH174012LT	12VDC/120mA	16 A/ 500VAC, 1NC	1219940000	153,20 TL	10
DRH174024LT	24VDC/60mA	16 A/ 500VAC, 1NC	1219950000	153,20 TL	10
DRH174048LT	48VDC/30mA	16 A/ 500VAC, 1NC	1219960000	161,10 TL	10
DRH174110LT	110VDC/13,03mA	16 A/ 500VAC, 1NC	1219970000	177,95 TL	10
DRH174220LT	220VDC/6,7mA	16 A/ 500VAC, 1NC	1219980000	177,95 TL	10
DRH174524LT	24VAC/101,7mA	16 A/ 500VAC, 1NC	1219990000	177,95 TL	10
DRH174548LT	48VAC/51,04mA	16 A/ 500VAC, 1NC	1220010000	177,95 TL	10
DRH174615LT	115VAC/21,2mA	16 A/ 500VAC, 1NC	1220020000	177,95 TL	10
DRH174730LT	230VAC/10,61mA	16 A/ 500VAC, 1NC	1220030000	177,95 TL	10
1 NC/1 NO Kontakt, 16 A / 250 V AC					
DRH275012LT	12VDC/120mA	16 A/250VAC, 1NO ve 1NC	1220040000	161,10 TL	10
DRH275024LT	24VDC/60mA	16 A/250VAC, 1NO ve 1NC	1220050000	161,10 TL	10
DRH275048LT	48VDC/30mA	16 A/250VAC, 1NO ve 1NC	1220060000	170,05 TL	10

Serinin devamı sayfa 108



DRH276012LT



SPW ECO 3CO



TRS 24VDC 1CO



TRS 5VDC 1CO 16A



TRS 24VDC 1NO HC

Tip	Giriş	Çıkış	Sipariş No	Fiyat/Birim	Ambalaj
DRH275110LT	110VDC/13,03mA	16 A/250VAC, 1NO ve 1NC	1220070000	186,30 TL	10
DRH275220LT	220VDC/6,7mA	16 A/250VAC, 1NO ve 1NC	1220080000	186,30 TL	10
DRH275524LT	24VAC/101,7mA	16 A/250VAC, 1NO ve 1NC	1220090000	186,30 TL	10
DRH275548LT	48VAC/51,04mA	16 A/250VAC, 1NO ve 1NC	1220110000	186,30 TL	10
DRH275615LT	115VAC/21,2mA	16 A/250VAC, 1NO ve 1NC	1220120000	186,30 TL	10
DRH275730LT	230VAC/10,61mA	16 A/250VAC, 1NO ve 1NC	1220130000	186,30 TL	10

2 NO Kontak, 16 A / 250 V AC

DRH276012LT	12VDC/120mA	16 A/250VAC, 2NO	1220140000	161,10 TL	10
DRH276024LT	24VDC/60mA	16 A/250VAC, 2NO	1220150000	161,10 TL	10
DRH276048LT	48VDC/30mA	16 A/250VAC, 2NO	1220170000	169,55 TL	10
DRH276110LT	110VDC/13,03mA	16 A/250VAC, 2NO	1220180000	186,30 TL	10
DRH276220LT	220VDC/6,7mA	16 A/250VAC, 2NO	1220190000	186,30 TL	10
DRH276524LT	24VAC/101,7mA	16 A/250VAC, 2NO	1220200000	186,30 TL	10
DRH276548LT	48VAC/51,04mA	16 A/250VAC, 2NO	1220210000	186,30 TL	10
DRH276615LT	115VAC/21,2mA	16 A/250VAC, 2NO	1220220000	186,30 TL	10
DRH276730LT	230VAC/10,61mA	16 A/250VAC, 2NO	1220230000	186,30 TL	10

• Güçlü DC yükleri anahtarlama uygunluk. • Ark önlüyücü mıknatıs mekanizması "Blowout magnet". • LED ve test butonu. • Yüksek DC yüklerin anahtarlamasında 3 A@ 220 V DC'ye kadar

DRH Tip Rölelerin Soket ve Aksesuarları

SPW ECO 3CO	Röle soketi	1220250000	50,30 TL	10
DRW/DRH CLIP M	Metal Klips	1220260000	4,20 TL	10
RIM 5 6/230VAC	4 kontak soket için RC filtre	1174670000	25,60 TL	10
RIM 5 6/230VDC	4 kontak soket için diyot	1174650000	25,60 TL	10

Term Serisi Röleler

1 CO Kontak 6A, 6,4 mm genişlik

TRS 24VDC 1CO	24 VDC	250V / 6A, 1CO	1122770000	64,80 TL	10
TRS 24VUC 1CO	24V AC/DC	250V / 6A, 1CO	1122780000	91,25 TL	10
TRS 120VUC 1CO	120V AC/DC	250V / 6A, 1CO	1122810000	120,15 TL	10
TRS 230VUC 1CO	230V AC/DC	250V / 6A, 1CO	1122820000	120,15 TL	10
TRS 120VAC RC 1CO	120V AC	250V / 6A, 1CO	1122830000	150,40 TL	10
TRS 230VAC RC 1CO	230V AC	250V / 6A, 1CO	1122840000	150,40 TL	10
TRS 24-230VUC 1CO	24 V.....230 VAC/dc üniversal giriş	250V / 6A, 1CO	1122850000	195,00 TL	10

1 CO Kontak 16A, 12,8 mm genişlik

TRS 5VDC 1CO 16A	5V DC	250V / 16A, 1CO	1479650000	112,70 TL	10
TRS 12VDC 1CO 16A	12V DC	250V / 16A, 1CO	1479670000	113,65 TL	10
TRS 24VDC 1CO 16A	24V DC	250V / 16A, 1CO	1479680000	111,30 TL	10
TRS 24VUC 1CO 16A	24V AC/DC	250V / 16A, 1CO	1479690000	129,45 TL	10
TRS 48VUC 1CO 16A	48V AC/DC	250V / 16A, 1CO	1479700000	129,45 TL	10
TRS 60VUC 1CO 16A	60V AC/DC	250V / 16A, 1CO	1479710000	131,75 TL	10
TRS 120VUC 1CO 16A	120V AC/DC	250V / 16A, 1CO	1479730000	137,35 TL	10
TRS 230VUC 1CO 16A	230V AC/DC	250V / 16A, 1CO	1479740000	137,35 TL	10
TRS 120VAC RC 1CO 16A	120V AC	250V / 16A, 1CO	1479750000	168,60 TL	10
TRS 230VAC RC 1CO 16A	230V AC	250V / 16A, 1CO	1479760000	164,90 TL	10
TRS 24-230VUC 1CO 16A	24 V.....230 VAC/dc üniversal giriş	250V / 16A, 1CO	1479770000	203,05 TL	10

1 NO Kontak 16A, 12,8 mm genişlik, Inrush Power HC (Inductive Yük Uygulamaları)

TRS 24VDC 1NO HC	24V DC	250V / 16A, 1NO	1479780000	128,05 TL	10
TRS 24-230VUC 1NO HC	24 V.....230 VAC/dc üniversal giriş	250V / 16A, 1NO	1479790000	220,80 TL	10

1 NO Kontak 16A, 12,8 mm genişlik, Inrush Power HCp (Capacitive Yük Uygulamaları)

TRS 24VDC 1NO HCP	24V DC	250V / 16A, 1NO	1479810000	152,75 TL	10
TRS 24-230VUC 1NO HCP	24 V.....230 VAC/dc üniversal giriş	250V / 16A, 1NO	1479830000	244,95 TL	10



TRS 24VDC 2CO



TIA SUBD 15S



TIAL F20



TXS SUPPLY



ZQV 1.5N/R6.4/10 GE



MCZ R 24VDC



ZQV 4N/10 GE



RSM 8RS 24VDC LP GEM.-

Tip	Giriş	Çıkış	Sipariş No	Fiyat/Birim	Ambalaj
2 CO Kontak, 12,8 mm genişlik					
TRS 24VDC 2CO	24 Vdc	250V / 2 X 8A, 2CO	1123490000	102,00 TL	10
TRS 24VUC 2CO	24 Vac/dc	250V / 2 X 8A, 2CO	1123500000	117,40 TL	10
TRS 120VUC 2CO	120 Vac/dc	250V / 2 X 8A, 2CO	1123530000	124,80 TL	10
TRS 230VUC 2CO	230 Vac/dc	250V / 2 X 8A, 2CO	1123540000	124,80 TL	10
TRS 120VAC RC 2CO	120 Vac	250V / 2 X 8A, 2CO	1123550000	154,15 TL	10
TRS 230VAC RC 2CO	230 Vac	250V / 2 X 8A, 2CO	1123570000	154,15 TL	10
TRS 24-230VUC 2CO	24 V....230 Vac/dc üniversal giriş	250V / 2 X 8A, 2CO	1123580000	194,25 TL	10
1 CO Kontak 6A, 6,4 mm genişlik Yayalı					
* TRZ 24VDC 1CO	24 VDC	250V / 6A, 1CO	1122880000	64,00 TL	10
* TRZ 24VUC 1CO	24V AC/DC	250V / 6A, 1CO	1122890000	91,25 TL	10
* TRZ 120VUC 1CO	120V AC/DC	250V / 6A, 1CO	1122920000	120,15 TL	10
* TRZ 230VUC 1CO	230V AC/DC	250V / 6A, 1CO	1122930000	120,15 TL	10
* TRZ 120VAC RC 1CO	120V AC	250V / 6A, 1CO	1122940000	150,40 TL	10
* TRZ 230VAC RC 1CO	230V AC	250V / 6A, 1CO	1122950000	150,40 TL	10
* TRZ 24-230VUC 1CO	24 V....230 VAC/dc üniversal giriş	250V / 6A, 1CO	1122970000	186,30 TL	10
Term Serisi Röle Aksesuarları					
TIA SUBD 15S	8 Adet TRS Röle için 15 Kutup SUB-D bağlantı tipi PLC Adaptörü		1463530000	470,00 TL	1
TIAL F10	8 Adet TRS Röle için 10 Kutuplu PLC arayüz bağlantısı- Adaptörü		1463540000	490,00 TL	1
TIAL F20	16 Adet TRS Röle için 20 Kutuplu PLC arayüz bağlantısı- Adaptörü		1463550000	630,00 TL	1
TXS SUPPLY	Besleme Terminali		1240780000	68,05 TL	10
TW TXS/TXZ R3.2	İzolasyon plakası		1240800000	7,95 TL	10
WEW 35/2 SW	Vidalı Tip Siyah Durdurucu		1061210000	18,85 TL	100
WS 10/6 MC NE WS			1828450000	0,792 TL	600
Not: 1 ve 2 enversör kontaklar Vidalı ve yaylı bağlantı 6.4 ve 12.8 mm röle genişliği ZQV ile köprülenebilir. Üniversal giriş 24...230 V AC/DC					
Term Serisi Röleler için Üst Köprüler					
ZQV 1.5N/R6.4/10 GE	10 Kutuplu, Sarı, 1 Kontak için		1193680000	23,75 TL	10
ZQV 1.5N/R6.4/19 GE	19 Kutuplu, Sarı, 1 Kontak için		1193690000	44,20 TL	10
ZQV 1.5N/R12.8/10 GE	10 Kutuplu, Sarı, 2 Kontak için		1193700000	46,60 TL	10
MCZ Serisi Röleler					
1 Enversör Kontak					
MCZ R 24VDC	24 Vdc / 6,3 mA	250 V / 6 A, 1CO	8365980000	127,15 TL	10
MCZ R 24VUC	24 Vac/dc / 10,8 mA	250 V / 6 A, 1CO	8390590000	222,20 TL	10
MCZ R 120VAC	120 Vac/dc / 7 mA	250 V / 6 A, 1CO	8420880000	277,55 TL	10
MCZ R 230VAC	230 Vac / 9,5 mA	250 V / 6 A, 1CO	8237710000	291,55 TL	10
MCZ Röle için Nihayet Plakası					
AP MCZ1.5	MCZ Nihayet Plakası		8389030000	13,05 TL	50
Not: 1 Enversör Kontak 250 VAC/6A ,6mm Röle Genişliği ,ZQV ile Köprülenebilir, Yeşil LED					
MCZ Serisi Röleler için Üst Köprüler					
ZQV 4N/10 GE	10'lu Sarı		1758260000	33,95 TL	20
ZQV 4N/10 RT	10'lu Kırmızı		1794040000	33,55 TL	20
ZQV 4N/10 BL	10'lu Mavi		1794050000	33,55 TL	20
ZQV 4N/41	41'li Sarı		1758270000	137,85 TL	10
ZQV 4N/41 RT	41'li Kırmızı		1794070000	137,85 TL	10
ZQV 4N/41 BL	41'li Mavi		1794080000	137,85 TL	10
Çoklu Röle Modülü					
RSM 8RS 24VDC LP GEM.-	24 Vdc / 23 mA	250 V / 6 A, 1CO	1113561001	90,00 €	1



TIMER BTM-S



TOP 5VDC/48VDC 0,1A



ZQV 4N/10 GE



TOS 24-230VUC 48VDC0,1A

Tip	Açıklama	Sipariş No	Fiyat/Birim	Ambalaj
Zaman Röleleri				
TIMER BTM-S	8 farklı Fonksiyon, 0,1 sn-120 Saat, 5A/250Vac	8647700000	64,50 €	10
TIMER BTMF-S	4 farklı Fonksiyon, 0,1 sn-120 Saat, 5A/250Vac	8647680000	55,70 €	10
TIMER BTR-S	Çekmede Gecikme, 0,1 sn-120 Saat, 5A/250Vac	8647720000	43,00 €	10
TIMER BTMT-S	İkiz Zamanlı, 0,1 sn-120 saat, 5A/250Vac	8647740000	70,00 €	10
ITS 24-240VUC 1C0 M7C	7 farklı Fonksiyon (bağımsız kontrol birimleri), Multi-Voltaj: 24-48 VDC, 24-240 VAC	2496190000	42,00 €	1
BT LOCK PEN	Zaman Röleleri İçin Özel Ayar Kalem	8659840000	14,00 €	5

Tip	Giriş	Çıkış	Sipariş No	Fiyat/Birim	Ambalaj
Termopto Serisi Optokuplörler					
100 mA DC Çıkış					
TOP 5VDC/48VDC 0,1A	5 Vdc	5...48 Vdc / 0,1 A	8950760000	96,40 TL	10
TOP 24VDC/48VDC 0,1A	24 Vdc	5...48 Vdc / 0,1 A	8950780000	96,40 TL	10
TOP 24VAC/48VDC 0,1A	24 Vac	5...48 Vdc / 0,1 A	8950860000	102,45 TL	10
TOP 120VAC/48VDC 0,1A	120 Vac	5...48 Vdc / 0,1 A	8950880000	112,25 TL	10
TOP 230VAC/48VDC 0,1A	230 Vac	5...48 Vdc / 0,1 A	8950890000	120,15 TL	10
500 mA DC Çıkış					
TOP 5VDC/48VDC 0,5A	5 Vdc	5...48 Vdc / 0,5 A	8950960000	120,60 TL	10
TOP 24VDC/48VDC 0,5A	24 Vdc	5...48 Vdc / 0,5 A	8950980000	120,60 TL	10
TOP 24VAC/48VDC 0,5A	24 Vac	5...48 Vdc / 0,5 A	8951060000	127,15 TL	10
TOP 120VAC/48VDC 0,5A	120 Vac	5...48 Vdc / 0,5 A	8951080000	136,00 TL	10
TOP 230VAC/48VDC 0,5A	230 Vac	5...48 Vdc / 0,5 A	8951090000	143,90 TL	10
100 mA AC Çıkış					
TOP 5VDC/230VAC 0,1A	5 Vdc	24...230 Vac / 0,1 A	8951160000	189,05 TL	10
TOP 24VDC/230VAC 0,1A	24 Vdc	24...230 Vac / 0,1 A	8951180000	189,05 TL	10
TOP 24VAC/230VAC 0,1A	24 Vac	24...230 Vac / 0,1 A	8951260000	195,15 TL	10
TOP 120VAC/230VAC 0,1A	120 Vac	24...230 Vac / 0,1 A	8951280000	204,05 TL	10
TOP 230VAC/230VAC 0,1A	230 Vac	24...230 Vac / 0,1 A	8951290000	212,35 TL	10
4 A DC Çıkış					
TOS 24VDC/24VDC 4A	24 Vdc	3...33Vdc / 4 A	1275100000	166,80 TL	10
Termopto Serisi Optokuplörler İçin Üst Köprüler					
ZQV 4N/10 GE	10'lu Sarı		1758260000	33,95 TL	20
ZQV 4N/10 RT	10'lu Kırmızı		1794040000	33,55 TL	20
ZQV 4N/10 BL	10'lu Mavi		1794050000	33,55 TL	20
ZQV 4N/41	41'li Sarı		1758270000	137,85 TL	10
ZQV 4N/41 RT	41'li Kırmızı		1794070000	137,85 TL	10
ZQV 4N/41 BL	41'li Mavi		1794080000	137,85 TL	10

Not: Push In bağlantı teknolojisi ile Termopto Serisi Optokuplörler elektromekanik rölelere alternatiftir.

Term Serisi Solid-State Röleler

100 mA DC Çıkış, 6,4 mm genişlik

TOS 24-230VUC 48VDC0,1A	24 V....230 Vac/dc universal giriş	0...48 Vdc / 100 mA	1127020000	247,80 TL	10
TOS 24VDC 48VDC0,1A	24 Vdc	0...48 Vdc / 100 mA	1126940000	133,20 TL	10
TOS 24VUC 48VDC0,1A	24 Vac/dc	0...48 Vdc / 100 mA	1126950000	148,10 TL	10
TOS 120VUC 48VDC0,1A	120 Vac/dc	0...48 Vdc / 100 mA	1126980000	172,80 TL	10
TOS 230VUC 48VDC0,1A	230 Vac/dc	0...48 Vdc / 100 mA	1126990000	172,80 TL	10
TOS 120VAC RC 48VDC0,1A	120 Vac	0...48 Vdc / 100 mA	1127000000	203,05 TL	10
TOS 230VAC RC 48VDC0,1A	230 Vac	0...48 Vdc / 100 mA	1127010000	203,05 TL	10

2 A DC Çıkış, 6,4 mm genişlik

TOS 24-230VUC 24VDC2A	24 V....230 Vac/dc universal giriş	0...24 Vdc / 2A	1127250000	311,60 TL	10
TOS 24VDC 24VDC2A	24 Vdc	0...24 Vdc / 2A	1127170000	139,70 TL	10
TOS 24VUC 24VDC2A	24 Vac/dc	0...24 Vdc / 2A	1127180000	204,95 TL	10

Serinin devamı sayfa 111



TOS 24VUC 230VAC1A



TXS SUPPLY



ZQV 1.5N/R6.4/10 GE



ZQV 4N/10 GE



MOS 24VDC/5-33VDC 10A

Tip	Giriş	Çıkış	Sipariş No	Fiyat/Birim	Ambalaj
TOS 120VUC 24VDC2A	120 Vac/dc	0...24 Vdc / 2A	1127210000	225,45 TL	10
TOS 230VUC 24VDC2A	230 Vac/dc	0...24 Vdc / 2A	1127220000	225,45 TL	10
TOS 120VAC RC 24VDC2A	120 Vac	0...24 Vdc / 2A	1127230000	255,20 TL	10
TOS 230VAC RC 24VDC2A	230 Vac	0...24 Vdc / 2A	1127240000	255,20 TL	10
1 A AC Çıkış, 6,4 mm genişlik					
TOS 24-230VUC 230VAC1A	24 V....230 Vac/dc üniversal giriş	24...240 Vac / 1A	1127500000	311,60 TL	10
TOS 24VDC 230VAC1A	24V DC	24...240 Vac / 1A	1127410000	190,00 TL	10
TOS 24VUC 230VAC1A	24V AC/DC	24...240 Vac / 1A	1127420000	205,40 TL	10
TOS 120VUC 230VAC1A	120V AC/DC	24...240 Vac / 1A	1127450000	225,45 TL	10
TOS 230VUC 230VAC1A	230V AC/DC	24...240 Vac / 1A	1127470000	225,45 TL	10
TOS 120VAC RC 230VAC1A	120V AC	24...240 Vac / 1A	1127480000	255,20 TL	10
TOS 230VAC RC 230VAC1A	230V AC	24...240 Vac / 1A	1127490000	255,20 TL	10
3,5 A DC Çıkış, 12,8 mm genişlik					
TOS 24-230VUC 24VDC3,5A	24 V....230 VAC/DC üniversal giriş	0...33 Vdc / 3,5A	1127640000	355,85 TL	10
TOS 24VDC 24VDC3,5A	24V DC	0...33 Vdc / 3,5A	1127630000	226,80 TL	10
1 A AC Çıkış, 12,8 mm genişlik					
TOS 24-230VUC 230VAC1A	24 V....230 VAC/DC üniversal giriş	12...275 Vac / 1A	1127690000	355,85 TL	10
TOS 24VDC 230VAC1A	24V DC	12...275 Vac / 1A	1127680000	226,80 TL	10
5 A DC Çıkış, 12,8 mm genişlik					
TOS 24VDC 24VDC5A	24V DC	3...33V DC 5A	1990960000	258,45 TL	10
TOS 24-230VUC 24VDC5A	24 V....230 VAC/DC üniversal giriş	3...33V DC 5A	1990970000	551,00 TL	10
Term Serisi Solid - State Aksesuarları					
TXS SUPPLY	Besleme Terminali		1240780000	68,05 TL	10
TW TXS/TXZ R3.2	İzolasyon plakası		1240800000	7,95 TL	10
WEW 35/2 SW	Vidalı Tip Siyah Durdurucu		1061210000	18,85 TL	100
WS 10/6 MC NE WS	Markalama		1828450000	0,792 TL	600
Not: 100 mA'den 5 A'e kadar ,Vidalı ve yaylı bağlantı, 6,4 mm ve 12,8 mm röle genişliği, Üniversal giriş 24...230 Vac/dc					
Term Serisi Solid-State Röleler için Üst Köprüler					
ZQV 1.5N/R6.4/10 GE	10 Kutuplu, Sarı, 1 Kontak için		1193680000	23,75 TL	10
ZQV 1.5N/R6.4/19 GE	19 Kutuplu, Sarı, 1 Kontak için		1193690000	44,20 TL	10
ZQV 1.5N/R12.8/10 GE	10 Kutuplu, Sarı, 2 Kontak için		1193700000	46,60 TL	10
Micro Serisi Optokuplörler için Üst Köprüler					
ZQV 4N/10 GE	10'lu Sarı		1758260000	33,95 TL	20
ZQV 4N/10 RT	10'lu Kırmızı		1794040000	33,55 TL	20
ZQV 4N/10 BL	10'lu Mavi		1794050000	33,55 TL	20
ZQV 4N/41	41'li Sarı		1758270000	137,85 TL	10
ZQV 4N/41 RT	41'li Kırmızı		1794070000	137,85 TL	10
ZQV 4N/41 BL	41'li Mavi		1794080000	137,85 TL	10
Özel Uygulamalar için Micro Opto Serisi Optokuplörler					
10 A Selonoid Sürücü					
MOS 24VDC/5-33VDC 10A	24 Vdc	5...33 Vdc / 10 A	8937940000	377,75 TL	1
Direkt Aktüatör Bağlantısı için					
MOS 24VDC/8-30VDC 2A	24 Vdc	8...30 Vdc / 2 A	8937970000	402,90 TL	1
300 VDC'ye Kadar İndüktif Yükler için					
MOS 24VDC/12-300VDC 1A	24 Vdc	12...300 Vdc / 1 A	8937830000	375,45 TL	1
1 kHz Elektronik Anahtarlama					
MOS 24VDC/5-48VDC 0,5A	24 Vdc	5...48 Vdc / 500 mA	8937980000	247,30 TL	1
100 kHz Yüksek Anahtarlama Frekansı					
MOS 12-28VDC 100kHz	12...28 Vdc	24 Vdc / 50 mA	8937990000	295,00 TL	1



PSSR 24VDC/1PH AC 25A



SCS 24VDC P1SIL3DS

Tip	Giriş	Çıkış	Sipariş No	Fiyat/Birim	Ambalaj
100 kHz TTL Sinyalden Dönüştürme					
MOS 5VTTL/24VDC 0,1A	5 V TTL	19.6...28.8 V / 100 mA	8937920000	247,30 TL	1
100 kHz TTL Sinyale Dönüştürme					
MOS 12-28VDC/5VTTL	12...28 Vdc	5 V TTL / 50 mA	8937930000	247,30 TL	1
PSSR Serisi Güç Solid-state Röleleri					
PSSR 24VDC/1PH AC 25A	1 Faz AC, 24VDC, 25A		1406200000	64,50 €	1
PSSR 230VAC/1PH AC 25A	1 Faz AC, 230VAC, 25A		1406220000	67,50 €	1
PSSR 24VDC/1PH AC 35A	1 Faz AC, 24VDC, 35A		1406210000	95,50 €	1
Güvenlik Röleleri (24V DC SIL 3 DN EN 61508)					
SCS 24VDC P1SIL3DS	24 Vdc Güvenlik Kategorisi: SIL3 DIN EN 61508		1303890000	96,50 €	1
SCS 24VDC P1SIL3DS M	24 Vdc Güvenlik Kategorisi: SIL3 DIN EN 61508, İzleme devresi		1303760000	130,50 €	1
SCS 24VDC P1SIL3DS MG3	24 Vdc Güvenlik Kategorisi: SIL3 DIN EN 61508, G3, İzleme devresi		1304040000	163,00 €	1
SCS 24VDC P2SIL3DSES	24 Vdc Güvenlik Kategorisi: SIL3 DIN EN 61508, Test girişi		1319270000	155,50 €	1
SCS 24VDC P2SIL3ES	24 Vdc Güvenlik Kategorisi: SIL3 DIN EN 61508, EN ISO 13849-1 Ple		1319280000	155,50 €	1
* SCS 24VDC P1SIL3DS I	24 Vdc Güvenlik Kategorisi: SIL3 DIN EN 61508 (Schneider Triconex® safety PLC için)		2500980000	95,00 €	1

Analog Sinyal Dönüştürücüler

Analog sinyal dönüştürücüler petrol, kimya, enerji, su arıtma, çimento ve demir çelik gibi birçok endüstri ve proses otomasyonunda kullanılmaktadırlar. Üretim prosesinde sıcaklık, basınç, akış miktarı, boş/dolu uygulamaları, ağırlık ve hız gibi parametrelerin ölçülüp denetlenmesi gerektiğinde kullanılırlar. Ölçülen sinyaller, proses zincirinde dış etkilerden etkilenmeden ve uzun mesafelerde gönderilmelidirler. Kararlılık ısı, elektromanyetik dalgalar, titreşim, paslanma gibi etkenlerden etkilenmemelidir. Patlama tehlikesi olan ortamlarda sinyal alışverişi devam etmelidir.

Aşağıdaki özelliklere sahiptirler:

- Sinyallerin galvanik izolasyonu
- Gelen sinyalin başka bir sinyale dönüştürülmesi
- Kuvvetlendirme, lineerleştirme, dönüştürme.
- Düşük sensör sinyallerinin hiçbir kayıp olmadan yukarılara taşınması
- Opsiyonel durum göstergeleri ve alarm kontakları dönüştürme prosesinin takip edilmesini sağlar.

Dönüştürücü ürün gurubu şu dönüştürme ve izolasyon fonksiyonlarını yerine getirebilir:

- DC/DC-Dönüştürme
- Gerilim
- Akım
- Sıcaklık-RTD ve Termokuplör
- Frekans
- Loadcell
- Potansiyometre
- AC-gerilim ve akım izleme
- Alarm (Sınır değeri)
- AD/DA-çeviriciler

Bu ürün grupları, 2-yollu izolasyonlu, 3-yollu izolasyonlu, aktif veya pasif dönüştürücü olarak mevcuttur.





ACT20P-BRIDGE-S



ACT20P-CI-2CO



ACT20P-AI-AO-DC-S



ACT20P-CMT-10-AO-RC-S

Tip	Giriş	Çıkış	Sipariş No	Fiyat/Birim	Ambalaj
ACT20P Serisi Universal Dönüştürücü					
ACT20P Serisi Load Cell Dönüştürücü					
ACT20P-BRIDGE-S	Load Cell	0 - 11V / 0-22mA	1067250000	372,00 €	1
ACT20P Hart Protokol Sinyal Dönüştürücüler					
ACT20P-CI-2CO	0(4)...20 mA 2/3 Kablolu, HART Dijital Sinyal	0(4)...20 mA	7760054115	215,00 €	1
ACT20P-2CI-2CO-12	0(4)...20 mA 2/3 Kablolu, HART Dijital Sinyal	0(4)...20 mA	7760054117	268,50 €	1
ACT20P Serisi Universal Limit Değer İzleme					
ACT20P-UI-2RCO-DC-S	Thermocouples: B, E, J, K, L, N, R, S, T, U, PT100/2-/3-Kablolu, PT200, PT1000, N120, Cu 10 Potentiometer: 1.2 kΩ - 500 kΩ, Resis- tance: 0 - 1.5 kΩ / 0 - 12 kΩ / 0 - 750 Ω	2 CO Alarm Çıkışı	7940045760	386,50 €	1
ACT20P-UI-AO-DO-LP-S	PT100 / 2-/3-/4-wire, PT1000/2- /3-/4-wire, PT200, N120, Thermocouples: B, E, J, K, L, N, R, S, T, U, Potentiometer	4...20 mA, 20...4 mA, Current loop, Loop Powered	1453210000	300,70 €	1
ACT20P-PRO-RTCI-AO-DO-S	Potenriometer: 10 - 150kΩ, Resis- tance: 0 - 15kΩ,	DO: NPN Transistör, alt ve üst limit alarm fonksiyonu, AO: Akım; 0..5V, 0..10V, ±5V, ±10V, Gerilim; ±20mA, ±10mA, 0..20mA	2448100000	315,00 €	1
ACT20P Serisi Universal DC İzolasyon ve Amplifikasyon Modülü					
ACT20P-AI-AO-DC-S	0...11 V / 0...22 mA	0...11 V / 0...22 mA	1477420000	240,50 €	1
ACT20P-PRO DCDC II-S	±20 mV...±300 V ±0.1mA...± 100 mA	0...±10 V, 0...±20 mA	1481970000	361,00 €	1
ACT20P Serisi DC/DC 3-Yollu İzolasyon					
ACT20P-CI-VO	0(4)...20 mA, 2/3 Kablolu,	0...10 V, 2...10 V,	1540010000	165,00 €	1
ACT20P Serisi DC/DC 2-Yollu İzolasyon, Çıkıştan Beslemeli					
ACT20P-VI-CO-OLP	0...10 V	4...20 mA	7760054121	157,85 €	1
ACT20P-VI1-CO-OLP	0...5 V	4...20 mA	7760054120	157,85 €	1
ACT20P-CI2-CO-OLP	4...20 mA	4...20 mA	7760054119	157,85 €	1
ACT20P Serisi DC/DC 2-Yollu İzolasyon, Çıkıştan Beslemeli, Çoklayıcı					
ACT20P-CI-2CO-OLP	4...20 mA	4...20 mA	7760054122	185,95 €	1
ACT20P Serisi DC/DC 2-Yollu İzolasyon, Girişten Beslemeli					
ACT20P-CI-CO-ILP	0(4)...20 mA	0(4)...20 mA	7760054123	138,25 €	1
ACT20P Serisi DC/DC 2-Yollu İzolasyon, Girişten Beslemeli, Çoklayıcı					
ACT20P-2CI-2CO-ILP	0(4)...20 mA	0(4)...20 mA	7760054124	210,00 €	1
ACT20P Serisi Akım İzleme Modülleri					
ACT20P-CMT-10-AO-RC-S	0...1/5/10 A UC Hall Sensor	0(4)...20 mA, -20...+20 mA 0...10 V, 2...10 V, 0...5 V, 1...5 V, -5...+5 V -10...+10 V, Röle Alarm Çıkışı	1510470000	246,00 €	1
ACT20P-CMT-30-AO-RC-S	0...20/25/30 A Hall Sensor	0(4)...20 mA, -20...+20 mA 0...10 V, 2...10 V, 0...5 V, 1...5 V, -5...+5 V -10...+10 V, Röle Alarm Çıkışı	1510540000	246,00 €	1
ACT20P-CMT-60-AO-RC-S	0...40/50/60 A UC Hall Sensor	0(4)...20 mA, -20...+20 mA 0...10 V, 2...10 V, 0...5 V, 1...5 V, -5...+5 V -10...+10 V, Röle Alarm Çıkışı	1510440000	245,80 €	1
ACT20P-CMT-60-RC-S	0...40/50/60 A UC Hall Sensor	Röle Alarm Çıkışı	1510390000	181,00 €	1
ACT20P-CML-10-AO-RC-S	0...1/5/10 A UC	0(4)...20 mA, -20...+20 mA, 0...10 V, 2...10 V, 0...5 V, 1...5 V, -5...+5 V, -10...+10 V, Röle Alarm Çıkışı	2044850000	210,00 €	1



ACT20C-GTW-100-MTCP-S



ACT20C-LBT-10



ACT20C-AI-AO-MTCP



ACT20X-SAI-HA-O-S



ACT20X-2HDI-2SDO-RNO-S

Tip	Giriş	Çıkış	Sipariş No	Fiyat/Birim	Ambalaj
ACT20P Serisi Gerilim İzleme Modülleri					
ACT20P-VMR-1PH-H	0-400 V AC/DC, 1 faz izleme, ayarlanabilir 3 kanal opsiyonu	2 CO Röle Çıkışlı	7760054164	195,00 €	1
ACT20P-VMR-3PH-IHP-H	180-500 V AC, 3 faz izleme	2 CO Röle Çıkışlı	7760054165	215,00 €	1
ACT20P-VM-AO-S	0-500 V AC, 1 faz izleme, ayarlanabilir 10 kanal opsiyonu	0(4)...20 mA, 0...10 V	7760054306	245,00 €	1
ACT20P Serisi Sıcaklık İzleme Modülleri					
ACT20P-TMR-RTI-S	PT100 2/3/4 kablolu, PTC: 0-4kΩ	2 CO Röle Çıkışlı	7760054305	200,00 €	1
ACT20C Ethernet Arabirimli Analog Sinyal Dönüştürücüler					
ACT20C-GTW-100-MTCP-S	Ethernet Gateway Modülü		1510370000	465,50 €	1
SET CH20M BUS	ACT 20C Haberleşme bus terminal seti / 250 mm		1335140000	724,00 TL	1
ACT20C-LBT-10	ACT 20C Bus termination durdurucu aparatı		1510340000	93,20 €	1
ACT20-FEED-IN-BASIC-S	Raydan besleme modülü / 0.5 - 2.5 A		1282490000	57,00 €	1
ACT20-FEED-IN-PRO-S	Raydan besleme modülü / 4 A		8965500000	208,80 €	1
ACT20C Ethernet Arabirimli İzolasyon Modülleri					
ACT20C-AI-AO-MTCP	0...20 mA, 4...20 mA	0...20 mA, 4...20 mA	1334490000	910,00 €	1
ACT20C Ethernet Arabirimli Akım İzleme Modülleri					
ACT20C-CMT-10-AO-RC-S	0...5/10 A UC	0(4)...20 mA, -20...+20 mA 0...10 V, 2...10 V, 0...5 V, 1.5 V, 5...+5 V -10...+10 V, Röle Alarm Çıkışı	1510240000	271,70 €	1
ACT20C-CML-10-AO-RC-S	0...5/10 A UC	0(4)...20 mA, -20...+20 mA 0...10 V, 2...10 V, 0...5 V, 1.5 V, 5...+5 V -10...+10 V, Röle Alarm Çıkışı	2044840000	270,00 €	1
ACT20C-CMT-60-AO-RC-S	0...40/50/60 A UC	0(4)...20 mA, -20...+20 mA 0...10 V, 2...10 V, 0...5 V, 1.5 V, 5...+5 V -10...+10 V, Röle Alarm Çıkışı	1510420000	271,70 €	1
ACT20X Serisi					
4-20 mA Akım İzolatörü					
ACT20X-SAI-HA-O-S	4...20 mA	4...20 mA	8965450000	234,50 €	1
ACT20X-2SAI-2HA-O-S	4...20 mA	4...20 mA	8965460000	327,80 €	1
ACT20X-HAI-SAO-S	4...20 mA (Sensör Beslemesi: 28 V DC)	4...20 mA	8965430000	240,00 €	1
ACT20X-2HAI-2SAO-S	4...20 mA (Sensör Beslemesi: 28 V DC)	4...20 mA	8965440000	328,00 €	1
ACT20X Çıkıştan Döngü Beslemeli Universal Dönüştürücü					
ACT20X-HUI-SAO-LP-S	RTD, TC, DC (mA, V)	4...20 mA	1318220000	361,00 €	1
Sıcaklık Transmitteri					
ACT20X-HTI-SAO-S	RTD, TC, DC(mA)	0(4)...20 / 20...4 mA	8965470000	302,00 €	1
ACT20X-2HTI-2SAO-S	RTD, TC, DC(mA)	0(4)...20 / 20...4 mA	8965480000	492,00 €	1
Universal Transmitter					
ACT20X-HUI-SAO-S	Universal, RTD,TC,DC (mA,mV)	0...23 mA	8965490000	327,00 €	1
Röle Çıkışlı Namur İzolasyon Transmitteri					
ACT20X-HDI-SDO-RNO-S	Namur 8V DC / 8 mA / 0...5 kHz	Röle, 1 NC / Alarm	8965340000	153,00 €	1
ACT20X-HDI-SDO-RNC-S	Namur 8V DC / 8 mA / 0...5 kHz	Röle, 1 NO / Alarm	8965350000	170,80 €	1
ACT20X-2HDI-2SDO-RNO-S	Namur 8V DC / 8 mA / 0...5 kHz	Röle, 1 NC / Alarm	8965370000	203,50 €	1
ACT20X-2HDI-2SDO-RNC-S	Namur 8V DC / 8 mA / 0...5 kHz	Röle, 1 NO / Alarm	8965380000	226,00 €	1
NPN Transistör Çıkışlı Namur İzolasyon Transmitteri					
ACT20X-HDI-SDO-S	Namur 8V DC / 8 mA / 0...5 kHz	NPN Transistor/Alarm, 1 NC	8965360000	164,00 €	1
ACT20X-2HDI-2SDO-S	Namur 8V DC / 8 mA / 0...5 kHz	NPN Transistor/Alarm, 1 NC	8965390000	224,00 €	1
Ateşleme Korumalı Selenoid Sürücü					
ACT20X-SDI-HDO-L-S	NPN, PNP / ≤28 V DC	Röle, 1 NC, Selenoid Driver	8965400000	187,50 €	1
ACT20X-2SDI-2HDO-S	NPN, PNP / ≤28 V DC	Röle, 1 NC, Selenoid Driver	8965420000	278,50 €	1
ACT20X-SDI-HDO-H-S	NPN, PNP / ≤28 V DC	Röle, 1 NC, Selenoid Driver	8965410000	209,00 €	1



ACT20M-CI-CO-ILP-S



ACT20M-BAI-AO-S



CBX200 USB



EPAK-2CI-2CO-ILP

Tip	Giriş	Çıkış	Sipariş No	Fiyat/Birim	Ambalaj
ACT20M Serisi					
DC / DC Pasif Akım İzolatörü					
ACT20M-CI-CO-ILP-S	0(4)...20 mA	0(4)...20 mA	1176070000	180,00 €	1
ACT20M-CI-CO-OLP-S	4...20 mA	4...20 mA	1176040000	168,00 €	1
ACT20M-2CI-2CO-ILP-S	0(4)...20 mA	0(4)...20 mA	1176080000	329,50 €	1
ACT20M-2CI-2CO-OLP-S	4...20 mA	4...20 mA	1176050000	329,50 €	1
DC / DC 3 Yollu Galvanik İzolasyon - Dip switch ile ayarlanabilir					
ACT20M-CI-CO-S	0(4)...20 mA	0(4)...20 mA	1175980000	155,75 €	1
ACT20M-AI-AO-E-S	0(2) - 10 V / 0(1) - 5 V / 0(4) - 20 mA	0(2) - 10 V / 0(1) - 5 V / 0(4) - 20 mA	1176010000	173,50 €	1
ACT20M-AI-AO-S	0(2) - 10 V / 0(1) - 5 V / 0(4) - 20 mA (Sensör Beslemesi: 17 V DC)	0(2) - 10 V / 0(1) - 5 V / 0(4) - 20 mA	1176000000	206,00 €	1
DC / DC 4 Yollu Galvanik İzolasyon - Dip switch ile ayarlanabilir					
ACT20M-BAI-AO-S	-10...+10 mA, -20 mA...+20 mA -5 V...+5 V, -10 V...+10 V	0(2) - 10 V / 0(1) - 5 V / 0(4) - 20 mA ± 10mA, ± 20mA	1375450000	186,00 €	1
Sinyal Çoklayıcı					
ACT20M-CI-2CO-S	0(4)...20 mA	0(4)...20 mA	1175990000	265,00 €	1
ACT20M-AI-2AO-S	0(2) - 10 V / 0(1) - 5 V / 0(4) - 20 mA	0(2) - 10 V / 0(1) - 5 V / 0(4) - 20 mA	1176020000	331,00 €	1
ACT20M-BAI-2AO-S	-10...+10 mA, -20 mA...+20 mA -5 V...+5 V, -10 V...+10 V	0(2) - 10 V / 0(1) - 5 V / 0(4) - 20 mA ± 10mA, ± 20mA	1375470000	300,00 €	1
Analog Sinyal Dönüştürücü - ACT 20 M Serisi PT100					
ACT20M-RTI-AO-S	PT100 -200...+850 °C 2/3/4Kablolu	0(2) - 10 V / 0(1) - 5 V / 0(4) - 20 mA	1375510000	139,70 €	1
ACT20M-RTI-AO-E-S	PT100 -200...+850 °C 2/3/4Kablolu	0(2) - 10 V / 0(1) - 5 V / 0(4) - 20 mA	1375520000	120,70 €	1
ACT20M-RTCI-CO-OLP-S	PT100-200...+850 °C 2/3/4Kablolu TCJ-100...+1200°C, TC K-200...+1370°C	0(4)...20 mA	1435590000	192,00 €	1
ACT20M-RTI-CO-EOLP-S	PT100 -200...+850 °C 2/3/4 Kablolu TC J -100...+1200°C, TC K -200...+1370°C	0(4)...20 mA	1435610000	146,50 €	1
ACT20M-TCI-AO-S	TC J -100...+1200°C, TCK -200...+1370°C	0(2) - 10 V / 0(1) - 5 V / 0(4) - 20 mA	1375480000	155,70 €	1
Universal Dönüştürücü - FDT/DTM yazılımı ile ayarlanabilir					
ACT20M-UI-AO-S	0...20 mA, 4...20mA 0(2)...10 V, 0(1)...5 V 10 Ω...10 kΩ, Thermocouples	0(4) - 20 mA / 0(2) - 10 V	1176030000	314,95 €	1
Programlama Kablosu					
CBX200 USB	Programlama aparatı		8978580000	90,00 €	1
E-PAK Serisi					
DC/DC 3-Yollu Galvanik İzolasyon					
* EPAK-CI-CO	0(4)...20 mA	0(4)...20 mA	7760054181	80,00 €	1
* EPAK-PCI-CO	0(4)...20 mA 2 kablolu sensör	0(4)...20 mA	7760054182	85,00 €	1
* EPAK-VI-VO	0...10 V	0...10 V	7760054175	115,00 €	1
* EPAK-CI-VO	4...20 mA	0...10 V	7760054176	125,00 €	1
* EPAK-PCI-VO	4...20 mA 2 kablolu sensör	0...10 V	7760054177	125,00 €	1
* EPAK-VI-CO	0...10 V	4...20 mA	7760054178	110,00 €	1
DC/DC 3-Yollu Galvanik İzolasyon Sinyal Splitter					
* EPAK-CI-2CO	1 x (0...20 mA, 4...20 mA)	2 x (0...20 mA, 4...20 mA)	7760054307	110,00 €	1
* EPAK-CI-4CO	1 x (0...20 mA, 4...20 mA)	4 x (0...20 mA, 4...20 mA)	7760054308	125,00 €	1
DC/DC 2-Yollu İzolasyon, Giriş Döngü Beslemeli					
* EPAK-CI-CO-ILP	4...20 mA (current loop)	4...20 mA	7760054179	75,00 €	1
* EPAK-2CI-2CO-ILP	2 x 4...20 mA (current loop)	2 x 4...20 mA (current loop)	7760054180	90,00 €	1
Akım İzleme Modülleri					
* EPAK-CM-CO-H	0.1...1A, 0.5...5A AC/DC	4...20 mA, Alarm output	7760054300	100,00 €	1
* EPAK-CMR-1PH-5-24V	0.1...1A, 0.5...5A AC/DC	1 CO Alarm çıkışı (24V Besleme)	7760054246	100,00 €	1
* EPAK-CMR-1PH-5-230V	0.1...1A, 0.5...5A AC/DC	1 CO Alarm çıkışı (230V Besleme)	7760054247	120,00 €	1



WAS5 CCC LP 0-20/0-20mA



WAS4 PT100/3 C 0/4-20mA



WAS5 PRO RTD



WAS4 PRO Freq



WAS6 TTA



CBX200 USB

Tip	Giriş	Çıkış	Sipariş No	Fiyat/Birim	Ambalaj
Gerilim İzleme Modülleri					
* EPAK-VM-CO-H	0...300V AC/DC, 0...125V AC, 0...30V DC	4...20 mA	7760054299	115,00 €	1
* EPAK-VMR-1PH-300-24V	30...300 - 6...60 V AC/DC	1 CO Alarm çıkışı (24V Besleme)	7760054244	140,00 €	1
* EPAK-VMR-1PH-300-230V	30...300 - 6...60 V AC/DC	1 CO Alarm çıkışı (230V Besleme)	7760054245	160,00 €	1
* EPAK-VMR-3PH-PH	400V AC (L-L) ±15%	1 CO Alarm çıkışı	7760054248	75,00 €	1
WAVE Serisi DC/DC					
Beslemesiz (Pasif) Akım İzolatörleri					
WAS5 CCC LP 0-20/0-20mA	0(4)...20 mA	0(4)...20 mA	8444950000	173,00 €	1
WAS5 CCC LP 0-20/0-20mA	2 x 0(4)...20 mA	2 x 0(4)...20 mA	8463580000	265,50 €	1
Çıkıştan Döngü Beslemeli					
WAS5 OLP	0...10 V / 0(4)...20 mA	4...20 mA	8543720000	216,50 €	1
WAS5 CCC 20LP	4...20 mA	4...20 mA	8581160000	247,50 €	1
DC/DC 2-Yollu İzolasyon, Çıkıştan Beslemeli					
WAS4 CCC DC 4-20/0-20mA	4...20 mA	0...20 mA	8445010000	132,80 €	1
WAS4 CVC DC 4-20/0-10V	4...20 mA	0...10 V	8445040000	132,80 €	1
DC/DC Girişten ve Çıkıştan Beslemeli					
WAS4 VVC DC 0-10/0-10V	0...10 V	0...10 V	8447130000	132,80 €	1
DC/DC Alarm 3-Yollu Galvanik İzolasyon					
WAS5 DC/Alarm	0...10 V / 0(4)...20 mA	2 CO Alarm çıkışı	8543820000	218,00 €	1
WAVE Serisi PT100					
PT 100, 2-Uçlu					
WTS4 PT100/2CO/420mA	PT 100 / 1,45 mA -200...+800 °C	0(4)...20 mA	8432210000	155,00 €	1
WTS4 PT100/2 V 0-10V	PT 100 / 1,45 mA -200...+800 °C	0...10 V	8432180000	155,00 €	1
PT 100, 3-Uçlu					
WTS4 PT100/3CO/420mA	PT 100 / 1,45 mA -200...+800 °C	0(4)...20 mA	8432150000	168,00 €	1
WTS4 PT100/3 V 0-10V	PT 100 / 1,45 mA -200...+800 °C	0...10 V	8432090000	168,00 €	1
PT 100, 4-Uçlu					
WTS4 PT100/4CO/420mA	PT 100 / 1,45 mA -200...+800 °C	0(4)...20 mA	8432270000	185,00 €	1
WTS4 PT100/4 V 0-10V	PT 100 / 1,45 mA -200...+800 °C	0...10 V	8432240000	185,00 €	1
WAVE Serisi PRO - Universal Tip					
PT100 2- /3- /4- Uçlu ve Ni100 2- /3- /4- Uçlu / Dip Switch ile Ayarlanabilir					
WAS5 PRO RTD	PT100/2/3/4 Kablolu, Ni100/2/3/4 Kablolu	0(4)...20 mA / 0...10 V	8560700000	212,00 €	1
Termokuplör Tip K, J, T, E, N, R, S, B / Dip Switch ile Ayarlanabilir					
WAS5 PRO Thermo	-200...+1820°C K, J, T, E, N, R, S, B	0(4)...20 mA / 0...10 V	8560720000	222,00 €	1
Frekans/DC Dönüştürücü / Dip Switch ile Ayarlanabilir					
WAS4 PRO Freq	2,3 Kablolu PNP/NPN, Namur	0(4)...20 mA / 0...10 V	8581180000	270,00 €	1
Load Cell Dönüştürücü / Dip Switch ile Ayarlanabilir					
WAS5 PRO Bridge	Load Cell	0(4)...20 mA / 0...10 V	8581200000	267,80 €	1
WAVE Data Serisi Sinyal Dönüştürücüler					
WDS2 RS232/RS485/422	RS232/RS485/422	RS232/RS485/422	8615700000	315,00 €	1
WDS2 RS232/TTY	RS232/TTY	RS232/TTY	8615690000	315,00 €	1
WAVE TTA					
WAS6 TTA	Universal Dönüştürücü		8939670000	374,00 €	1
WAZ6 TTA	Universal Dönüştürücü (Yay Bağlantılı)		8939680000	374,00 €	1
CBX200 USB	Programlama aparatı		8978580000	90,00 €	1
WAVE Kontrol - İzleme Modülleri					
Akım İzleme Modülleri					
WAS1 CMA LP 1/5/10A ac	1/5/10 A AC	4...20 mA, 2 Kablolu	8528650000	129,50 €	1

Not: 8523400000 nolu Ürün Portföyden kaldırılmış olup muadil ürün 2044850000 - ACT20P-CML-10-AO-RC-S dir. | 8545830000 nolu Ürün Portföyden kaldırılmış olup muadil ürün 1510540000 - ACT20P-CMT-30-AO-RC-S dir.



ZQV 4N/10 GE



PICOPAK-CI-CO-LP-P



MCZ CCC 0-20mA/0-20mA



CMA-22-60-5A-1,5VA-1



CMA-31-75-5A-2,5VA-1



KCMA-18-50-1A-1VA-3

Tip	Giriş	Çıkış	Sipariş No	Fiyat/Birim	Ambalaj
Gerilim İzleme Modülleri					
WAS2 VMA V ac	0...450V AC Ayarlanabilir	0(4)...20 mA /0...10 V	8581220000	329,00 €	1
WAS5 VMR 1ph	24...264V AC/DC	Röle Çıkışlı	8705640000	236,70 €	1
WAS2 VMR 3ph	80...400V AC/DC 3 Faz	Röle Çıkışlı	8705630000	318,00 €	1
Üst Köprüler					
ZQV 4N/10 GE	10'lu Sarı		1758260000	33,95 TL	20
ZQV 4N/10 RT	10'lu Kırmızı		1794040000	33,55 TL	20
ZQV 4N/10 BL	10'lu Mavi		1794050000	33,55 TL	20
ZQV 4N/41	41'li Sarı		1758270000	137,85 TL	10
ZQV 4N/41 RT	41'li Kırmızı		1794070000	137,85 TL	10
ZQV 4N/41 BL	41'li Mavi		1794080000	137,85 TL	10
PicoPac Serisi					
* PICOPAK-CI-CO-LP-P	4...20 mA	4...20 mA	2501110000	125,00 €	1
* PICOPAK-CI-CO-LP-S	4...20 mA	4...20 mA	2517450000	125,00 €	1
MCZ Serisi					
DC/DC Pasif Akım İzolatörü					
MCZ CCC 0-20mA/0-20mA	0(4)...20 mA	0(4)...20 mA	8411190000	143,55 €	10
PT100 Sıcaklık Dönüştürücü					
MCZ PT100/3 CLP 0...100C	0...100 °C 2/3 Kablolu	4...20 mA	8425720000	115,70 €	10
MCZ PT100/3 CLP 0...120C	0...120 °C 2/3 Kablolu	4...20 mA	8483680000	115,70 €	10
MCZ PT100/3 CLP 0...150C	0...150 °C 2/3 Kablolu	4...20 mA	8604420000	115,70 €	10
MCZ PT100/3 CLP 0...200C	0...200 °C 2/3 Kablolu	4...20 mA	8473010000	115,70 €	10
MCZ PT100/3 CLP 0...300C	0...300 °C 2/3 Kablolu	4...20 mA	8473020000	115,70 €	10
MCZ PT100/3 CLP 50C...+150C	-50...150 °C 2/3 Kablolu	4...20 mA	8473000000	115,70 €	10
MCZ PT100/3 CLP 40C...100C	-40...100 °C 2/3 Kablolu	4...20 mA	8604430000	115,70 €	10
Gerilim ve Akım Seviye İzleme					
MCZ SC 0-10V	0...10 V	2 PNP	8260280000	91,00 €	10
MCZ SC 0-20MA	0...20 mA	2 PNP	8227350000	91,00 €	10
Tip Primer Sekonder Sipariş No Fiyat/Birim Ambalaj					
Akım Trafoları					
Bara Tipi					
CMA-22-60-5A-1,5VA-1	60 A	5 A, Telorans 1, Delik Çapı: 22.5 mm	1482140000	76,00 €	1
CMA-22-100-5A-2,5VA-0,5	100 A	5 A, Telorans 0.5, Delik Çapı: 22.5 mm	1482150000	114,00 €	1
CMA-22-250-5A-5VA-0,5	250 A	5 A, Telorans 0.5, Delik Çapı: 22.5 mm	1482170000	76,00 €	1
CMA-22-500-5A-5VA-0,5	500 A	5 A, Telorans 0.5, Delik Çapı: 22.5 mm	1482220000	76,00 €	1
CMA-22-600-5A-5VA-0,5	600 A	5 A, Telorans 0.5, Delik Çapı: 22.5 mm	1482180000	76,00 €	1
Bara Tipi Push-In Bağlantı					
CMA-31-75-5A-2,5VA-1	75 A	5 A, Telorans 1, Delik Çapı: 25.7 mm	1482040000	41,50 €	1
CMA-31-100-5A-2,5VA-1	100 A	5 A, Telorans 1, Delik Çapı: 25.7 mm	1482030000	41,50 €	1
CMA-31-250-5A-5VA-0,5	250 A	5 A, Telorans 0.5, Delik Çapı: 25.7 mm	1482050000	69,00 €	1
CMA-31-500-5A-5VA-0,5	500 A	5 A, Telorans 0.5, Delik Çapı: 25.7 mm	1482070000	69,00 €	1
CMA-31-750-5A-5VA-0,5	750 A	5 A, Telorans 0.5, Delik Çapı: 25.7 mm	1482080000	72,50 €	1
Kablo Girişli					
KCMA-18-50-1A-1VA-3	50 A	1 A, Telorans 3, Delik Çapı: 18.5 mm	1482020000	267,50 €	1
KCMA-18-100-1A-1,25VA-3	100 A	1 A, Telorans 3, Delik Çapı: 18.5 mm	1482010000	267,50 €	1
KCMA-18-250-1A-1,5VA-1	250 A	1 A, Telorans 1, Delik Çapı: 18.5 mm	1482000000	267,50 €	1
KCMA-32-400-1A-5VA-1	400 A	1 A, Telorans 1, Delik Çapı: 18.5 mm	1481990000	284,50 €	1
KCMA-32-600-1A-5VA-1	600 A	1 A, Telorans 1, Delik Çapı: 18.5 mm	1481980000	284,50 €	1

Enerji Analizörleri

Makine ve tesislerin enerji verimliliklerinin ölçülerek verimliliklerinin artırılması için elektriksel parametrelerin takibi ve izlenmesine ihtiyaç duyulmakta ve enerji yönetim yapıları oluşturulmaktadır.

Weidmüller genişleyen enerji izleme ürün ailesi ile tesislerin ve makinelerin ihtiyaç duyduğu izleme modülleri, enerji verimlilik analizörleri ve yardımcı ekipmanları ile enerji yönetim sistemlerinin tüm ihtiyaçlarına komple çözümler sunmaktadır.

ISO 50001 standartları dâhilinde kurulan enerji yönetim sistemlerinde enerji analizörlerinin önemli bir rolü vardır. Bu ürünlerin hafıza kayıt, ekranda okunan değerlerin gösterilmesi ve güç akış diyagramlarının analizleri konusunda yetkin olmaları gerekmektedir.

Weidmüller'in sunmuş olduğu enerji izleme modülleri ile tüm bu datalar kolaylıkla izlenir, kaydedilir ve analizleri ile sistemlerin enerji verimlilikleri standartlara uygun bir şekilde takip edilebilir.



Enerji Analizörleri



ENERGY METER D370



ENERGY METER 330



ENERGY ANALYSER D550



ENERGY ANALYSER 550

Tip	Açıklama	Sipariş No	Fiyat/Birim	Ambalaj
Ray Tipi Şebeke Analizörleri				
ENERGY METER D370	Akım: 1/5 A, Gerilim L-L: 80 ... 415 Vrms, Gerilim L-N: 80 ... 240 V AC, Class 0.5s, Tolerans: %1, Harmonik: 2. ve 25. distorsiyon arası	2425470000	525,00 €	1
ENERGY METER D370-UL	Akım: 1/5 A, Gerilim L-L: 80 ... 415 Vrms, Gerilim L-N: 80 ... 240 V AC, Class 0.5s, Tolerans: %1, Digital Output: 2, Harmonik: 2. ve 25. distorsiyon arası, UL sertifikasyonu	2425480000	540,00 €	1
ENERGY METER D650	Akım: 1/5 A, Gerilim L-L: 18...1000 Vrms, Gerilim L-N: 10...600 V AC, Class 0.5s, Tolerans: %0.2, Digital Input: 2, Digital Output: 2, Harmonik: 2. ve 40. distorsiyon arası, Memory: 4 MB, Protokol: Modbus RTU, UL sertifikasyonu	2425490000	1.070,00 €	1
Front Panel Tip Şebeke Analizörleri				
ENERGY METER 330	Akım: 1/5 A, Gerilim L-L: 86 ... 442 Vrms, Gerilim L-N: 50 ... 255 V AC, Class 2, Tolerans: %1	2425410000	325,00 €	1
ENERGY METER 350	Akım: 1/5 A, Gerilim L-L: 86 ... 442 Vrms, Gerilim L-N: 50 ... 255 V AC, Class 2, Tolerans: %1, Digital Output: 2	2425420000	420,00 €	1
* ENERGY METER 520-230	Akım: 1/5 A, Gerilim L-L: 480V AC, Gerilim L-N: 280V AC, Class 0.5s, Tolerans: %0.2, Digital Input: 2, Digital Output: 2, Harmonik: 2. ve 40. distorsiyon arası, Memory: 4 MB, Protokol: Modbus RTU, UL sertifikasyonu	2500880000	585,00 €	1
* ENERGY METER 520-24	Akım: 1/5 A, Gerilim L-L: 480V AC, Gerilim L-N: 280V AC, Class 0.5s, Tolerans: %0.2, Digital Input: 2, Digital Output: 2, Harmonik: 2. ve 40. distorsiyon arası, Memory: 4 MB, Protokol: Modbus RTU, UL sertifikasyonu	2500860000	585,00 €	1
ENERGY METER 525	Akım: 1/5 A, Gerilim L-L: 18 ... 520 Vrms, Gerilim L-N: 10 ... 300 V AC, Class 0.5s, Tolerans: V: %0.2, A: %0.5, Harmonik: 2. ve 40. distorsiyon arası, Protokol: Modbus / TCP	2425430000	615,00 €	1
* ENERGY METER 700-PN-230	Akım: 1/5 A, Gerilim L-L: 480V AC, Gerilim L-N: 280V AC, Class 0.5s, Tolerans: %0.2, Digital Input: 2, Digital Output: 2, Harmonik: 2. ve 40. distorsiyon arası, Memory: 4 MB, Protokol: PROFINET, Modbus RTU, Modbus TCP/IP, Modbus RTU over Ethernet, SNMP, UL sertifikasyonu	2500890000	925,00 €	1
* ENERGY METER 700-PN-24	Akım: 1/5 A, Gerilim L-L: 480V AC, Gerilim L-N: 280V AC, Class 0.5s, Tolerans: %0.2, Digital Input: 2, Digital Output: 2, Harmonik: 2. ve 40. distorsiyon arası, Memory: 4 MB, Protokol: PROFINET, Modbus RTU, Modbus TCP/IP, Modbus RTU over Ethernet, SNMP, UL sertifikasyonu	2500870000	925,00 €	1
ENERGY METER 610-PB	Akım: 1/5 A, Gerilim L-L: 18 ... 520 Vrms, Gerilim L-N: 10 ... 300 V AC, Class 0.5s, Tolerans: V: %0.2, A: %0.5, Harmonik: 2. ve 40. distorsiyon arası, Digital input: 4, Digital output: 6, Memory: 256 MB, Protokol: Modbus RTU, Profibus DP V0	2425450000	850,00 €	1
ENERGY METER 750	Akım: 1/5 A, Gerilim L-L: 18 ... 520 Vrms, Gerilim L-N: 10 ... 300 V AC, Class 0.5s, Tolerans: V: %0.2, A: %0.5, Harmonik: 2. ve 40. distorsiyon arası, Digital input: 4, Digital output: 6, Memory: 256 MB, Protokol: Modbus RTU, Profibus DP V0	2425460000	1.310,00 €	1
POWER MONITOR	LCD Ekran, Modbus/RTU (RS485), V, I, Var, PF, F, °C	1423550000	417,00 €	1
POWER MONITOR 51A	LCD Ekran, Modbus/RTU (RS485), V, I, Var, PF, F, °C,	1470260000	466,00 €	1
Kalite Analizörleri				
ENERGY ANALYSER D550	Akım: 1/5 A, Gerilim L-L: 18...1000 Vrms, Gerilim L-N: 10...600 V AC, Class 0.5s, Tolerans: V: %0.2, A: %0.2, Harmonik: 2. ve 40. distorsiyon arası, Digital input: 2, Digital output: 2, Memory: 128 MB, Protokol: TCP/IP, DHCP Client (BootP), Modbus/TCP (Port 502), ICMP (Ping), NTP, Modbus RTU over Ethernet (Port 8000), TFTP	2425510000	1.600,00 €	1
ENERGY ANALYSER 550	Akım: 1/5 A, Gerilim L-L: 18...1000 Vrms, Gerilim L-N: 10...600 V AC, Class 0.2s, Tolerans: V: %0.1, A: %0.2, Harmonik: 2. ve 40. distorsiyon arası, Digital input: 8, Digital output: 5, Memory: 256 MB, Protokol: TCP/IP, DHCP Client (BootP), Modbus/TCP (Port 502), ICMP (Ping), NTP, Profibus DP V0, SMTP, TFTP, FTP, SNMP	2425500000	2.500,00 €	1
* ENERGY ANALYSER 750-230	Akım: 1/5 A, Gerilim L-L: 600V AC Gerilim L-N: 347V AC, Protokol: Modbus RTU, Modbus-Gateway, Modbus TCP/IP, Modbus RTU over Ethernet, SNMP, Profibus DP V0, BACnet	2534130000	3.880,00 €	1
* ENERGY ANALYSER 750-24	Akım: 1/5 A, Gerilim L-L: 600V AC Gerilim L-N: 347V AC, Protokol: Modbus RTU, Modbus-Gateway, Modbus TCP/IP, Modbus RTU over Ethernet, SNMP, Profibus DP V0, BACnet	2534160000	3.880,00 €	1
Enerji Logger				
ENERGY LOGGER D550		2425520000	860,00 €	1

Güç Kaynakları - ConnectPower

Güç kaynakları otomasyon sistemlerinin enerji beslemelerinde kullanılır.

Weidmüller güç kaynakları uzun çalışma ömürleri ve verimlilikleri ile rakiplerinden farklılaşmaktadır.

PRO-Max / PRO-Eco / PROtop

PRO-Max / PRO-Eco serisi güç kaynakları stabil şekilde 5,12,24,48 V DC güç değerini garanti eder ve az yer kaplar. 1 ve 3 fazlı olarak seçilebilir. Ray üzerinde aralarında boşluk bırakmadan monte edilebilir. Kritik uygulamalar için yüksek verimliliğe sahiptir. Buna rağmen aşırı yüklenmeye dayanıklı fazla rezervleri vardır. -25°C...+70°C arası geniş çalışma sıcaklığı aralığı hemen her ortamda güvenli kullanımı sağlar. Çok geniş giriş gerilim imkanı ile hem DC hem de AC de çalışabilir.

- 1 fazlı olarak: 3 A, 5 A, 7.5 A, 10 A, 20 A ve 40 A
- 3 fazlı olarak: 5 A, 10 A, 20 A ve 40 A

Regülesiz Güç Kaynakları

Kompakt yapıda olan bu güç kaynakları dinamik yükler için 36 W...1000W arası güç seçenekleri ile 24 Vdc gerilim sağlar. Giriş ve çıkış arasında izolasyon bir trafo ile sağlanır.

Özellikleri:

- Giriş gerilimi ~230V +/- ~15V veya ~400V +/- ~15V, 50/60 Hz
- Kısa devreye karşı emniyet sistemi
- Anahtar deliği şeklinde montaj yuvası ile zamandan tasarruf
- 144 W'a kadar 35mm DIN rayına monte edilebilir





PRO ECO 72W 24V 3A



PRO ECO3 120W 24V 5A



PRO MAX 70W 5V 14A



PRO MAX3 120W 24V 5A



PRO TOP1 72W 24V 3A

Tip	Giriş	Çıkış	Sipariş No	Fiyat/Birim	Ambalaj
PROeco - Anahtarlama					
Tek Fazlı Sistemler					
PRO ECO 72W 24V 3A	85...264 V AC / 80...370 V DC	22...28 V DC 3A	1469470000	73,45 €	1
PRO ECO 120W 24V 5A	85...264 V AC / 80...370 V DC	22...28 V DC 5A	1469480000	96,90 €	1
PRO ECO 240W 24V 10A	85...264 V AC / 80...370 V DC	22...28 V DC 10A	1469490000	173,40 €	1
PRO ECO 480W 24V 20A	85...264 V AC / 80...370 V DC	22...28 V DC 20A	1469510000	235,00 €	1
PRO ECO 960W 24V 40A	85...264 V AC / 80...370 V DC	22...28 V DC 40A	1469520000	459,00 €	1
PRO ECO 72W 12V 6A	85...264 V AC / 80...370 V DC	10...16 V DC 6A	1469570000	80,00 €	1
PRO ECO 120W 12V 10A	85...264 V AC / 80...370 V DC	10...16 V DC 10A	1469580000	130,00 €	1
PRO ECO 240W 48V 5A	85...264 V AC / 80...370 V DC	42...56 V DC 5A	1469590000	120,00 €	1
PRO ECO 480W 48V 10A	85...264 V AC / 80...370 V DC	42...56 V DC 10A	1469610000	240,00 €	1
3 Fazlı Sistemler					
PRO ECO3 120W 24V 5A	3 x 500V...3 x 400V AC / 450...800V DC	22...28 V DC 5A	1469530000	130,00 €	1
PRO ECO3 240W 24V 10A	3 x 500V...3 x 400V AC / 450...800V DC	22...28 V DC 10A	1469540000	180,00 €	1
PRO ECO3 480W 24V 20A	3 x 500V...3 x 400V AC / 450...800V DC	22...28 V DC 20A	1469550000	255,00 €	1
PRO ECO3 960W 24V 40A	3 x 500V...3 x 400V AC / 450...800V DC	22...28 V DC 40A	1469560000	460,00 €	1
Diyot Modülleri PROeco					
CP DM 10	0-20 A max.	40 V DC max. / 2 x 0-10 A	8710620000	72,80 €	1
PROmax Anahtarlama Güç Kaynakları					
Tek Fazlı Sistemler					
PRO MAX 70W 5V 14A	85...277 V AC / 80...370 V DC	4.5 - 7 V DC / 14 A (Pot)	1478210000	105,00 €	1
PRO MAX 72W 12V 6A	85...277 V AC / 80...370 V DC	10 - 15 V DC / 6 A (Pot)	1478220000	140,00 €	1
PRO MAX 120W 12V 10A	85...277 V AC / 80...370 V DC	10 - 15 V DC / 10 A (Pot)	1478230000	210,00 €	1
PRO MAX 72W 24V 3A	85...277 V AC / 80...370 V DC	22.5 - 29.5 V DC / 3 A (Pot)	1478100000	120,00 €	1
PRO MAX 120W 24V 5A	85...277 V AC / 80...370 V DC	22.5 - 29.5 V DC / 5 A (Pot)	1478110000	153,00 €	1
PRO MAX 180W 24V 7,5A	85...277 V AC / 80...370 V DC	22.5 - 29.5 V DC / 7.5 A (Pot)	1478120000	190,00 €	1
PRO MAX 240W 24V 10A	85...277 V AC / 80...370 V DC	22.5 - 29.5 V DC / 10 A (Pot)	1478130000	255,00 €	1
PRO MAX 480W 24V 20A	85...277 V AC / 80...370 V DC	22.5 - 29.5 V DC / 20 A (Pot)	1478140000	367,00 €	1
PRO MAX 960W 24V 40A	85...277 V AC / 80...370 V DC	22.5 - 29.5 V DC / 40 A (Pot)	1478150000	590,00 €	1
PRO MAX 240W 48V 5A	85...277 V AC / 80...370 V DC	30 - 56 V DC / 5 A (Pot)	1478240000	220,00 €	1
PRO MAX 480W 48V 10A	85...277 V AC / 80...370 V DC	30 - 56 V DC / 10 A (Pot)	1478250000	420,00 €	1
PRO MAX 960W 48V 20A	85...277 V AC / 80...370 V DC	30 - 56 V DC / 20 A (Pot)	1478270000	630,00 €	1
Üç Fazlı Sistemler					
PRO MAX3 120W 24V 5A	320-575 VAC / 450-800VDC	22.5 - 29.5 V DC / 5 A (Pot)	1478170000	250,00 €	1
PRO MAX3 240W 24V 10A	320-575 VAC / 450-800VDC	22.5 - 29.5 V DC / 10 A (Pot)	1478180000	290,00 €	1
PRO MAX3 480W 24V 20A	320-575 VAC / 450-800VDC	22.5 - 29.5 V DC / 20 A (Pot)	1478190000	380,00 €	1
PRO MAX3 960W 24V 40A	320-575 VAC / 450-800VDC	22.5 - 29.5 V DC / 40 A (Pot)	1478200000	630,00 €	1
PRO M Diyot Modülleri					
CP M DM20	2 X 10 A max veya 1 X 20 A / 24VDC		1222210000	93,50 €	1
CP M DM40	2 x 20 A max veya 1 X 40 A / 24VDC		1222220000	117,00 €	1
PRO M Kapasite Modülü					
CP M CAP	18...30 Vdc		1222240000	63,50 €	1
PROtop - Dynamic Current Limiting - Single/Paralel Mode - EX Alan İçin					
PRO TOP1 72W 24V 3A	85...277 V AC / 80 ... 410 V DC	22.5...29 V DC	2466850000	150,00 €	1
PRO TOP1 120W 24V 5A	85...277 V AC / 80 ... 410 V DC	22.5...29 V DC	2466870000	170,00 €	1
PRO TOP1 240W 24V 10A	85...277 V AC / 80 ... 410 V DC	22.5...29 V DC	2466880000	270,00 €	1
PRO TOP1 480W 24V 20A	85...277 V AC / 80 ... 410 V DC	22.5...29 V DC	2466890000	380,00 €	1
PRO TOP1 960W 24V 40A	85...277 V AC / 80 ... 410 V DC	22.5...29 V DC	2466900000	600,00 €	1
PRO TOP1 480W 48V 10A	85...277 V AC / 80 ... 410 V DC	45...56 V DC	2467030000	440,00 €	1
PRO TOP1 960W 48V 20A	85...277 V AC / 80 ... 410 V DC	45...56 V DC	2466920000	645,00 €	1
PRO TOP1 120W 12V 10A	85...277 V AC / 80 ... 410 V DC	11...15 V DC	2466910000	225,00 €	1



CP T SNT 70W 12V 6A



CP SNT 24W 5V 2A



CP DC UPS 24V 20A/10A



CP A BATTERY 24V DC3.4AH



PRO DCDC 120W 24V 5A

Tip	Açıklama	Sipariş No	Fiyat/Birim	Ambalaj
PROtop - Dynamic Current Limiting - Single/Paralel Mode - EX Alan İçin				
PROtop Haberleşme Modülü				
* PRO COM CAN OPEN	2 x RJ45 plug-in connectors	2467320000	65,00 €	1
PROtop Haberleşme Kablosu				
* PRO CAB SUBD-RJ45 0.5M	0.5 m (9 pin sub-D konektör / IP 20 RJ45)	2578530000	25,00 €	1
* PRO CAB SUBD-RJ45 1.0M	1 m (9 pin sub-D konektör / IP 20 RJ45)	2578550000	27,00 €	1
* PRO CAB SUBD-RJ45 2.5M	2.5 m (9 pin sub-D konektör / IP 20 RJ45)	2578560000	29,00 €	1

Tip	Giriş	Çıkış	Sipariş No	Fiyat/Birim	Ambalaj
PRO-H - Anahtarlama - EX Alan İçin					
CP T SNT 70W 12V 6A	85-264 VAC	12 V DC / 6 A	1105430000	232,70 €	1
CP T SNT 140W 12V 12A	85-132 VAC / 187-264 VAC	12 V DC / 12 A	1105440000	334,00 €	1
CP T SNT 90W 24V 3,8A	85-264 VAC	24 V DC / 3,8 A	1105790000	306,50 €	1
CP T SNT 180W 24V 7,5A	85-132 VAC / 187-264 VAC	24 V DC / 7,5 A	1105810000	432,50 €	1
CP T SNT 360W 24V 15A	85-132 VAC / 187-264 VAC	24 V DC / 15 A	1105820000	560,00 €	1
CP T SNT 600W 24V 25A	85-132 VAC / 187-264 VAC	24 V DC / 25 A	1105840000	681,00 €	1
CP T SNT 180W 48V 4A	85-132 VAC / 187-264 VAC	48 V DC / 4 A	1105850000	342,00 €	1
CP T SNT 360W 48V 7,5A	85-132 VAC / 187-264 VAC	48 V DC / 7,5 A	1105860000	466,00 €	1
CP T SNT 600W 48V 12,5A	85-132 VAC / 187-264 VAC	48 V DC / 12,5 A	1105870000	619,00 €	1

Tip	Giriş	Çıkış	Sipariş No	Fiyat/Birim	Ambalaj
INSTAPOWER - Anahtarlama					
CP SNT 24W 5V 2A	85-265 V AC / 120-300 V DC	5 V DC / 2 A	9928890005	106,50 €	1
CP SNT 25W 5V 5A	85-264 V AC / 110-370 V DC	4-8 V DC (Pot) / 5 A	8754960000	66,50 €	1
CP SNT 48W 12V 4A	85-264 V AC / 110-370 V DC	9-15 V DC (Pot) / 4 A	8754970000	65,00 €	1
CP SNT 24W 24V 1A	85-265 V AC / 120-300 V DC	24 V DC / 1 A	9928890024	87,50 €	1
CP SNT 48W 24V 2A	85-264 V AC / 110-370 V DC	15-28 V DC (Pot) / 2 A	8739140000	65,00 €	1
CP SNT 48W 48V 1A	85-264 V AC / 110-370 V DC	46-55 V DC (Pot) / 1 A	8879230000	66,50 €	1

Tip	Giriş	Sipariş No	Fiyat/Birim	Ambalaj
UPS Kontrol - Batarya - Buffer modülleri				
CP DC UPS 24V 20A/10A	UPS Kontrol modülü 24 Vdc, 20 A / 10 A	1370050010	282,00 €	1
CP DC UPS 24V 40A	UPS Kontrol modülü 24 Vdc, 40A	1370040010	478,00 €	1
CP A BATTERY 24V DC3.4AH	Batarya 11,3 min @ 10 A / 5 min @ 20 A	1251070000	192,90 €	1
CP A BATTERY 24V DC7.2AH	Batarya 26,5 min @ 10 A / 11,5 min @ 20 A / 5 min @ 30 A	1251080000	230,50 €	1
CP A BATTERY 24V DC12AH	Batarya 51 min @ 10 A / 22,7 min @ 20 A / 9,2 min @ 30 A	1251090000	320,80 €	1
CP A BATTERY 24V DC17AH	Batarya 81 min @ 10 A / 34,2 min @ 20 A / 13,5 min @ 30 A	1251110000	435,75 €	1
CP DC BUFFER 24V 20A	Buffer modülü 24 Vdc, 20 A,	1251220000	278,00 €	1

Tip	Giriş	Çıkış	Sipariş No	Fiyat/Birim	Ambalaj
DC/DC Konvertör					
PRO DCDC 120W 24V 5A	24 V DC	22.5...29.5 V DC 5A	2001800000	146,70 €	1
PRO DCDC 240W 24V 10A	24 V DC	22.5...29.5 V DC 10A	2001810000	230,50 €	1
PRO DCDC 480W 24V 20A	24 V DC	22.5...29.5 V DC 20A	2001820000	315,00 €	1
DCDC 24V-120V 230W	24 V DC	96 V DC / 144 V DC, 2A	1507190000	686,00 €	1

Tip	Açıklama	Sipariş No	Fiyat/Birim	Ambalaj
Redundancy Modül				
* PRO RM 10 10 ...	2 x 10 A Eşit Yük Paylaşımı için Redundancy Modülü 32 V DC	2486090000	130,00 €	1
* PRO RM 20 10 ...	2 x 20 A Eşit Yük Paylaşımı için Redundancy Modülü 32 V DC	2486100000	150,00 €	1
* PRO RM 40 10 ...	2 x 40 A Eşit Yük Paylaşımı için Redundancy Modülü 32 V DC	2486110000	200,00 €	1



AMG FIM-0



AMG ELM-1F

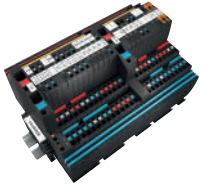

maxGUARD



AMG ELM-6D CO



AMG OD



AMG DIS



AMG AM

Tip	Açıklama	Sipariş No	Fiyat/Birim	Ambalaj
maxGUARD Elektronik Sigorta Modülleri				
maxGUARD Besleme Modülleri				
AMG FIM-0	18 ... 31.2 V DC, 40A Pasif Dağıtım Bloğu	2081870000	6,75 €	1
AMG FIM-C	18 ... 31.2 V DC, 40A Dağıtım Bloğu, Alarm ve Reset Fonksiyonlu	2081880000	29,00 €	1
AMG FIM-0 Ex	18 ... 31.2 V DC, 40A Pasif Dağıtım Bloğu Ex	2082530000	9,00 €	1
AMG FIM-C Ex	18 ... 31.2 V DC, 40A Dağıtım Bloğu, Alarm ve Reset Fonksiyonlu Ex	2082540000	33,00 €	1
maxGUARD Elektronik Sigorta Modülleri				
AMG ELM-1F	1A Sabit Değer	2080420000	31,00 €	1
AMG ELM-2F	2A Sabit Değer	2080480000	31,00 €	1
AMG ELM-4F	4A Sabit Değer	2080490000	32,00 €	1
AMG ELM-6F	6A Sabit Değer	2080500000	32,00 €	1
AMG ELM-8F	8A Sabit Değer	2080600000	34,00 €	1
AMG ELM-10F	10A Sabit Değer	2080650000	34,00 €	1
AMG ELM-Q2222	4 Kanal 2A sabit	2080750000	105,00 €	1
AMG ELM-Q2244	4 Kanal 2 x 2A, 2 x 4A	2081650000	105,00 €	1
AMG ELM-Q2266	4 Kanal 2 x 2A, 2 x 6A	2081820000	115,00 €	1
AMG ELM-Q4444	4 Kanal 4 x 4A	2080880000	105,00 €	1
AMG ELM-Q6666	4 Kanal 4 x 6A	2080920000	115,00 €	1
AMG ELM-1F CL2	1A Sabit Değer, Class 2 approved	2491270000	35,00 €	1
AMG ELM-2F CL2	2A Sabit Değer, Class 2 approved	2491280000	35,00 €	1
AMG ELM-4F CL2	4A Sabit Değer, Class 2 approved	2491290000	36,00 €	1
AMG ELM-6	6A'e Kadar Ayarlanabilir	2080360000	40,00 €	1
AMG ELM-12	12A'e Kadar Ayarlanabilir	2080410000	45,00 €	1
AMG ELM-1F EX	1A Sabit Değer Ex	2082040000	35,00 €	1
AMG ELM-2F EX	2A Sabit Değer Ex	2082050000	35,00 €	1
AMG ELM-4F EX	4A Sabit Değer Ex	2082060000	36,00 €	1
AMG ELM-6F EX	6A Sabit Değer Ex	2082310000	38,00 €	1
AMG ELM-8F EX	8A Sabit Değer Ex	2082320000	40,00 €	1
AMG ELM-10F EX	10A Sabit Değer Ex	2082430000	40,00 €	1
AMG ELM-6 EX	6A'e Kadar Ayarlanabilir Ex	2082000000	50,00 €	1
AMG ELM-12 EX	12A'e Kadar Ayarlanabilir Ex	2082010000	55,00 €	1
maxGUARD Elektronik Yük İzleme				
AMG ELM-6D CO	6A röle çıkışlı	2082440000	55,00 €	1
AMG ELM-10D CO	10A röle çıkışlı	2082470000	60,00 €	1
maxGUARD Potansiyel Dağıtım Klemensleri				
AMG DIS	Ölçme Ayırma Klemensi	2123050000	4,50 €	10
AMG MD	4 x Negatif	2122930000	2,25 €	10
AMG OD	2 x Pozitif, 2 x Negatif	2122910000	2,25 €	10
AMG PD	4 x Pozitif	2122920000	2,25 €	10
AMG OD EX	2 x Pozitif, 2 x Negatif Ex	2495090000	3,00 €	10
AMG PD EX	4 x Pozitif Ex	2495070000	3,00 €	10
AMG MD EX	4 x Negatif Ex	2495040000	3,00 €	10
AMG XMD EX	4 x Negatif Ex	2495080000	3,50 €	10
AMG DIS EX	Ölçme Ayırma Klemensi Ex	2495100000	6,00 €	10
maxGUARD Alarm Modülü				
AMG AM	(2 x NO)	2081890000	31,00 €	1
AMG AM CO	(2 x NO) Ex	2082770000	34,00 €	1
maxGUARD Kontrol Modülü				
AMG CM	Operasyon duruş ve erken uyarı modülü	2081900000	29,00 €	1
AMG CM EX	Operasyon duruş ve erken uyarı modülü Ex	2083360000	34,00 €	1



ZQV 4N/4



ZQV 4N/4 BL



ZQV 4N/4



CP E SNT 25W 5V 5A



CP E SNT 50W 5V 10A

Tip	Açıklama	Sipariş No	Fiyat/Birim	Ambalaj
maxGUARD Aksesuarları				
AMG PP	Ayrırma Plakası	2123000000	1,25 €	40
AMG EP	Sonlandırma Plakası	2495380000	2,50 €	30
Turuncu Tarak Köprü				
ZQV 4N/2	2 pol	1527930000	3,70 TL	60
ZQV 4N/3	3 pol	1527940000	6,80 TL	60
ZQV 4N/4	4 pol	1527970000	10,15 TL	60
ZQV 4N/5	5 pol	1527980000	13,30 TL	60
ZQV 4N/6	6 pol	1527990000	16,55 TL	20
ZQV 4N/7	7 pol	1528020000	19,70 TL	20
ZQV 4N/8	8 pol	1528030000	22,95 TL	20
ZQV 4N/9	9 pol	1528070000	26,00 TL	20
ZQV 4N/10	10 pol	1528090000	29,85 TL	20
ZQV 4N/50	50 pol	1528130000	170,45 TL	5
Mavi Tarak Köprü				
ZQV 4N/2 BL	2 pol	1528040000	3,65 TL	60
ZQV 4N/3 BL	3 pol	1528080000	6,60 TL	60
ZQV 4N/4 BL	4 pol	1528120000	9,85 TL	60
ZQV 4N/5 BL	5 pol	1528140000	12,95 TL	60
ZQV 4N/6 BL	6 pol	1528170000	16,15 TL	20
ZQV 4N/7 BL	7 pol	1528180000	19,15 TL	20
ZQV 4N/8 BL	8 pol	1528190000	22,35 TL	20
ZQV 4N/9 BL	9 pol	1528220000	25,40 TL	20
ZQV 4N/10 BL	10 pol	1528230000	29,10 TL	20
ZQV 4N/50 BL	50 pol	1528240000	166,05 TL	5
Kırmızı Tarak Köprü				
ZQV 4N/2	2 pol	2460450000	3,65 TL	60
ZQV 4N/3	3 pol	2460810000	6,60 TL	60
ZQV 4N/4	4 pol	2460800000	9,85 TL	60
ZQV 4N/5	5 pol	2460790000	12,95 TL	60
ZQV 4N/6	6 pol	2460780000	16,15 TL	20
ZQV 4N/7	7 pol	2460770000	19,15 TL	20
ZQV 4N/8	8 pol	2460760000	22,35 TL	20
ZQV 4N/9	9 pol	2460750000	25,40 TL	20
ZQV 4N/10	10 pol	2460740000	29,10 TL	20
ZQV 4N/50	50 pol	2460730000	166,05 TL	5
PRO-E				
Tek Faz 25W Sistemler				
CP E SNT 25W 5V 5A	85...264 V AC/110...370 V DC	5VDC / 5A	1202640000	21,25 € 1
CP E SNT 25W 12V 2.1A	85...264 V AC/110...370 V DC	12VDC / 2,1A	1202630000	21,25 € 1
CP E SNT 25W 24V 1.1A	85...264 V AC/110...370 V DC	24VDC / 1.1 A	1202620000	21,25 € 1
CP E SNT 25W 48V 0.57A	85...264 V AC/110...370 V DC	48VDC / 0,57A	1202610000	21,25 € 1
Tek Faz 50W Sistemler				
CP E SNT 50W 5V 10A	85...264 V AC/110...370 V DC	5VDC / 10A	1202590000	30,75 € 1
CP E SNT 50W 12V 4.2A	85...264 V AC/110...370 V DC	12VDC / 4.2A	1202580000	30,75 € 1
CP E SNT 50W 24V 2.2A	85...264 V AC/110...370 V DC	24VDC / 2.2A	1202450000	30,75 € 1
CP E SNT 50W 48V 1.1A	85...264 V AC/110...370 V DC	48VDC / 1.1A	1202460000	30,75 € 1

Güç Kaynakları



CP E SNT 75W 5V 12A



CP E SNT 100W 5V 16A



CP E SNT 150W 12V 12.5A



CP E SNT 250W 12V 21A



CP E SNT 350W 24V 14.6A



FreeCon



CP SNT 12W 24V 0.5A

Tip	Giriş	Çıkış	Sipariş No	Fiyat/Birim	Ambalaj
Tek Faz 75W Sistemler					
CP E SNT 75W 5V 12A	85...264 V AC / 110...370 V DC	5VDC / 12A	1202470000	35,50 €	1
CP E SNT 75W 12V 6A	85...264 V AC / 110...370 V DC	12VDC / 6A	1202480000	35,50 €	1
CP E SNT 75W 48V 1.6A	85...264 V AC / 110...370 V DC	48VDC / 1.6A	1202510000	35,50 €	1
Tek Faz 100W Sistemler					
CP E SNT 100W 5V 16A	88...132 V AC / 176...264 V AC ops./250...370 V DC	5VDC / 16A	1165820000	45,60 €	1
CP E SNT 100W 12V 8.5A	88...132 V AC / 176...264 V AC ops./250...370 V DC	12VDC / 8.5A	1165830000	45,60 €	1
CP E SNT 100W 24V 4.5A	88...132 V AC / 176...264 V AC ops./250...370 V DC	24VDC / 4.5A	1165840000	45,60 €	1
CP E SNT 100W 48V 2.3A	88...132 V AC / 176...264 V AC ops./250...370 V DC	48VDC / 2.3A	1165850000	45,60 €	1
Tek Faz 150W Sistemler					
CP E SNT 150W 12V 12.5A	88...132 V AC / 176...264 V AC ops./250...370 V DC	12VDC / 12.5A	1165870000	51,70 €	1
CP E SNT 150W 24V 6.5A	88...132 V AC / 176...264 V AC ops./250...370 V DC	24VDC / 6.5A	1165880000	51,70 €	1
CP E SNT 150W 48V 3.3A	88...132 V AC / 176...264 V AC ops./250...370 V DC	48VDC / 3.3A	1165890000	51,70 €	1
Tek Faz 250W Sistemler					
CP E SNT 250W 12V 21A	88...132 V AC / 176...264 V AC ops./250...370 V DC	12VDC / 21A	1202520000	78,30 €	1
CP E SNT 250W 24V 10.5A	88...132 V AC / 176...264 V AC ops./250...370 V DC	24VDC / 10.5A	1202530000	78,30 €	1
CP E SNT 250W 48V 5.2A	88...132 V AC / 176...264 V AC ops./250...370 V DC	48VDC / 5.2A	1202540000	78,30 €	1
BRACKET 250W	raya montaj parçası		7760052061	2,85 €	1
Tek Faz 350W Sistemler					
CP E SNT 350W 24V 14.6A	85...264 V AC / 110...370 V DC	24VDC / 14.6A	1202550000	110,50 €	1
CP E SNT 350W 48V 7.3A	85...264 V AC / 110...370 V DC	48VDC / 7.3A	1202560000	110,50 €	1
BRACKET 250W	raya montaj parçası		7760052061	2,85 €	1
FreeCon Wireless Enerji Aktarım Modülü					
IE-CL240W-PP-BASE	Primary Side 24V DC		1547440000	810,00 €	1
IE-CL240W-PP-REMOTE	Secondary side 10A-0.5mm		1547450000	690,00 €	1
IE-CL-MOUNT-CLIP	Clip Aparatı		1994360000	Sorunuz	1
IE-CL-MOUNT-PROFILE	Montaj Profili		1994370000	Sorunuz	1
WAVESERIES - Anahtarlamalı					
CP SNT 12W 24V 0.5A	85-265 V AC / 120-300 V DC	24 V DC / 0,5 A	9918840024	141,00 €	1

Aşırı Gerilim Koruma Modülleri

Weidmüller aşırı gerilim koruma modülleri normal değerleri aşan gerilim piklerini sınır noktasına ulaşmadan çalışma gerilimine indirir. İzolasyon koordinasyonu DIN VDE 0110 standartlarında belirtilen değerlerden daha iyi değerlere sahiptir. İyi bir aşırı gerilim koruma modülü şu kriterlerden belli olur:

- Hızlı reaksiyon
- Yıldırım akımı taşıma kapasitesi
- Çok az artı gerilim

Weidmüller bu kriterleri tamamıyla karşılayan ürünler imal eder. Ürünler, kullanılacak yere göre tek bir komponent, ya da bu komponentlerin kombinasyonlarından oluşur.

Aşırı gerilim koruma sınıfı Tip 1

Ana trafolarla tesis edilir. Yıldırım düştüğü zaman kendilerinden sonra gelen ekipmanları korur.

Aşırı gerilim koruma sınıfı Tip 2

Kullanım yeri alt dağıtım panelleridir. Uzak yıldırım etkilerine ve şebekeden gelen piklere karşı etkilidir.

Aşırı gerilim koruma sınıfı Tip 3

Son cihazların korunması için kullanılır. Koruma seviyeleri daha hassastır.

Tamamıyla bir koruma sağlamak için bütün riskleri göz önünde bulundurmak gerekir. En son cihaza yapılan koruma hiçbir zaman yakın yıldırıma karşı koruma sağlamaz

Aşırı Gerilim Koruma Modüllerinin Ölçü Kontrol Devrelerinde Kullanımı (MSR)

Weidmüller ölçü kontrol devreleri için koruma modüllerini ilk olarak 20 yıl önce üretti. Değişik gerilim aşma komponentleri kullanılarak sürekli geliştirilen ürünler sayesinde Weidmüller çok kapsamlı çözümler sunmaktadır. Ürün portföyünde klemenslere entegre edilmiş, vidalı, yaylı veya push in bağlantı teknolojilerine sahip çok sayıda alternatifler bulunmaktadır.

Uygulamalar:

- 0 (4)-20 mA Analog sinyaller
- 0-10V Analog sinyaller
- Digital sinyaller
- Analog şalt sinyaller



Aşırı Gerilim Koruma Modülleri



VPU I 1 R LCF 280V/25KA



VPU I 3 LCF 280V/25KA



VPU I 1 R 280V/12,5KA



VPU II 1+1 R 280V/40KA



VPU III R 230V/6KV AC



VPU III SO LD+A



BNC Connector / M-F

Tip	Açıklama	Sipariş No	Fiyat/Birim	Ambalaj
Class I (B Sınıfı)				
VPU I 1 R LCF 280V/25KA	8/20 µs deşarj akım:25kA, 1 faz	1351570000	195,00 €	1
VPU I 1+1 R LCF 280V/25KA	8/20 µs deşarj akım:25kA, 1 faz+ 1 Nötr	1351740000	346,50 €	1
VPU I 3 R LCF 280V/25KA	8/20 µs deşarj akım:25kA, 3 faz	1351670000	558,00 €	1
VPU I 3+1 R LCF 280V/25KA	8/20 µs deşarj akım:25kA, 3 faz+1 Nötr	1351770000	737,00 €	1
VPU I 1 LCF 280V/35KA	10/350 µs deşarj akım:35kA	1351350000	259,00 €	1
VPU I 1 N-PE 260V/100KA	N-PE,8/20µs deşarj akım:100kA	1351920000	180,00 €	1
Class I+II (B+C) (3 Faz + Nötr)				
VPU I 3 LCF 280V/25KA	8/20 µs deşarj akım:25kA, 3 faz,Tip I+II/Röle çıkışı yok	1351690000	509,00 €	1
VPU I 3+1 LCF 280V/25KA	8/20 µs deşarj akım:25kA, 3 faz+ 1 Nötr,Tip I+II/Röle çıkışı yok	1351780000	680,00 €	1
Class I+II (B+C)				
VPU I 1 R 280V/12,5KA	10/350 µs deşarj akım:12,5kA, 1 faz,Tip I+II, Röle Çıkışlı	1352140000	80,00 €	1
VPU I 2 R 280V/12,5KA	10/350 µs deşarj akım:12,5kA, 2 faz,Tip I+II, Röle Çıkışlı	1352170000	150,00 €	1
VPU I 3 R 280V/12,5KA	10/350 µs deşarj akım:12,5kA, 3 faz,Tip I+II, Röle Çıkışlı	1352220000	225,00 €	1
VPU I 4 R 280V/12,5KA	10/350 µs deşarj akım:12,5kA, 4 faz,Tip I+II, Röle Çıkışlı	1352190000	289,00 €	1
VPU I 1 280V/12,5KA	10/350 µs deşarj akım:12,5kA, 1 faz,Tip I+II, Röle Çıkışı yok	1352130000	69,50 €	1
VPU I 2 280V/12,5KA	10/350 µs deşarj akım:12,5kA, 2 faz,Tip I+II, Röle Çıkışı yok	1352150000	128,50 €	1
VPU I 3 280V/12,5KA	10/350 µs deşarj akım:12,5kA, 3 faz,Tip I+II, Röle Çıkışı yok	1352200000	193,00 €	1
VPU I 4 280V/12,5KA	10/350 µs deşarj akım:12,5kA, 4 faz,Tip I+II, Röle Çıkışı yok	1352180000	257,00 €	1
VPU I 3+1 280V/12,5KA	10/350 µs deşarj akım:12,5kA, 3 faz+ 1 Nötr,Tip I+II, Röle Çıkışı yok	1352230000	364,00 €	1
VPU I 3+1 R 280V/12,5KA	10/350 µs deşarj akım:12,5kA, 3 faz+ 1 Nötr,Tip I+II, Röle Çıkışlı	1352240000	396,00 €	1
Class II (C Sınıfı)				
VPU II 1 R 280V/40KA	8/20 µs deşarj akım:20kA, 1 faz, Tip II, Röle çıkışlı	1352590000	42,90 €	1
VPU II 2 R 280V/40KA	8/20 µs deşarj akım:20kA, 2 faz, Tip II, Röle çıkışlı	1352620000	85,70 €	1
VPU II 3 R 280V/40KA	8/20 µs deşarj akım:20kA, 3 faz, Tip II, Röle çıkışlı	1352720000	128,50 €	1
VPU II 4 R 280V/40KA	8/20 µs deşarj akım:20kA, 4 faz, Tip II, Röle çıkışlı	1352690000	171,50 €	1
VPU II 1 280V/40KA	8/20 µs deşarj akım:20kA, 1 faz, Tip II, Röle çıkışı yok	1352580000	37,50 €	1
VPU II 2 280V/40KA	8/20 µs deşarj akım:20kA, 2 faz, Tip II, Röle çıkışı yok	1352600000	75,00 €	1
VPU II 3 280V/40KA	8/20 µs deşarj akım:20kA, 3 faz, Tip II, Röle çıkışı yok	1352700000	101,75 €	1
VPU II 4 280V/40KA	8/20 µs deşarj akım:20kA, 4 faz, Tip II, Röle çıkışı yok	1352680000	128,50 €	1
Class II (C Sınıfı) TN ve TT sistem				
VPU II 1+1 R 280V/40KA	8/20 µs deşarj akım:20kA, 1 faz + 1 Nötr, Tip II, Röle çıkışlı	1352640000	85,70 €	1
VPU II 3+1 R 280V/40KA	8/20 µs deşarj akım:20kA, 3 faz + 1 Nötr, Tip II, Röle çıkışlı	1352670000	171,50 €	1
VPU II 1+1 280V/40KA	8/20 µs deşarj akım:20kA, 1 faz + 1 Nötr, Tip II, Röle çıkışı yok	1352630000	75,00 €	1
VPU II 3+1 280V/40KA	8/20 µs deşarj akım:20kA, 3 faz + 1 Nötr, Tip II, Röle çıkışı yok	1352650000	155,50 €	1
Class III (D Sınıfı)				
VPU III R 230V/6KV AC	8/20 µs deşarj akım:3kA,230VAC, Tip III	1351650000	69,50 €	1
VPU III R 120V/6KV AC/DC	8/20 µs deşarj akım:3kA,120VAC/DC, Tip III	1351630000	69,50 €	1
VPU III R 48V/4KV AC/DC	8/20 µs deşarj akım:2kA,48VAC/DC, Tip III	1351600000	69,50 €	1
VPU III R 24V/4KV AC/DC	8/20 µs deşarj akım:2kA,24VAC/DC, Tip III	1351580000	69,50 €	1
VPU III R 12V/4KV AC/DC	8/20 µs deşarj akım:2kA,12VAC/DC, Tip III	1351550000	69,50 €	1
Class III (D Sınıfı) Seyyar Tip				
VPU III SO LD+A	Tip III priz koruma, akustik alarm	1351700000	53,50 €	1
VPU III SO LD	Tip III priz koruma	1351680000	53,50 €	1
Koaksiyel Kablolar İçin Yıldırım Korumalar				
BNC Connector / M-F	Video, 8/20 µs deşarj akım:20kA	8947820000	91,00 €	1
N Connector / M-F	GSM, 8/20 µs deşarj akım:20kA	8947830000	91,00 €	1
F Connector / M-F	SAT, 8/20 µs deşarj akım:20kA	8947840000	91,00 €	1
UHF Connector / M-F	Analog, 8/20 µs deşarj akım:20kA	8947850000	75,00 €	1



VARIRECTOR LOGGER 30



VSPC 1CL 24VDC R



VSPC 2SL 5VDC R

Tip	Açıklama	Sipariş No	Fiyat/Birim	Ambalaj
Aşırı Gerilim İzleme Modülü				
VARIRECTOR LOGGER 30	LCD, max. puls sayısı: 80, 8/20 µs max. deşarj akım dayanımı 40kA	1428780000	514,00 €	1
Analog Sinyaller İçin Ani Aşırı Gerilim Korumalar				
VSPC 1CL 5VDC R	20 kA, 1 Kanal, Alarm	8951530000	139,50 €	1
VSPC 1CL 12VDC R	20 kA, 1 Kanal, Alarm	8951540000	139,50 €	1
VSPC 1CL 24VDC R	20 kA, 1 Kanal, Alarm	8951550000	139,50 €	1
VSPC 1CL 24VAC R	20 kA, 1 Kanal, Alarm	8951560000	139,50 €	1
VSPC 2CL 5VDC R	20 kA, 2 Kanal, Alarm	8951460000	192,80 €	1
VSPC 2CL 12VDC R	20 kA, 2 Kanal, Alarm	8951470000	192,80 €	1
VSPC 2CL 24VDC R	20 kA, 2 Kanal, Alarm	8951480000	192,80 €	1
VSPC 1CL 5VDC	20 kA, 1 Kanal	8924420000	91,00 €	1
VSPC 1CL 12VDC	20 kA, 1 Kanal	8924450000	91,00 €	1
VSPC 1CL 24VDC	20 kA, 1 Kanal	8924480000	91,00 €	1
VSPC 1CL 24VAC	20 kA, 1 Kanal	8924500000	91,00 €	1
VSPC 1CL 48VAC	20 kA, 1 Kanal	8924520000	91,00 €	1
VSPC 1CL 60VAC	20 kA, 1 Kanal	8924530000	91,00 €	1
VSPC 2CL 5VDC	20 kA, 2 Kanal	8924400000	171,50 €	1
VSPC 2CL 12VDC	20 kA, 2 Kanal	8924440000	171,50 €	1
VSPC 2CL 24VDC	20 kA, 2 Kanal	8924470000	171,50 €	1
VSPC 2CL 24VAC	20 kA, 2 Kanal	8924490000	171,50 €	1
VSPC 2CL 48VAC	20 kA, 2 Kanal	8951490000	171,50 €	1
VSPC BASE 1CL R	1 Kanal, Alarm, Doğrudan Topraklama	8951730000	42,90 €	1
VSPC BASE 1CL FG R	1 Kanal, Alarm Dolaylı Topraklama	8951740000	42,90 €	1
VSPC BASE 1CL	1 Kanal, Doğrudan Topraklama	8924730000	32,00 €	1
VSPC BASE 1CL FG	1 Kanal, Spark Gap ile Doğrudan	8924290000	37,50 €	1
VSPC BASE 2CL R	2 Kanal, Alarm, Doğrudan Topraklama	8951710000	64,25 €	1
VSPC BASE 2CL FG R	2 Kanal, Alarm Dolaylı Topraklama	8951720000	72,90 €	1
VSPC BASE 2CL	2 Kanal, Doğrudan Topraklama	8924710000	54,50 €	1
VSPC BASE 2CL FG	2 Kanal Spark Gap ile Doğrudan	8924270000	58,90 €	1
Dijital Sinyal İçin Ani Aşırı Gerilim Korumalar				
VSPC 2SL 5VDC R	20 kA, 2 Kanal, Alarm / 5 V DC / 300 mA	8951610000	139,50 €	1
VSPC 2SL 12VDC R	20 kA, 2 Kanal, Alarm / 12 V DC / 300 mA	8951620000	139,50 €	1
VSPC 2SL 24VDC R	20 kA, 2 Kanal, Alarm / 24 V DC / 300 mA	8951630000	139,50 €	1
VSPC 2SL 24VAC R	20 kA, 2 Kanal, Alarm / 24 V AC / 300 mA	8951640000	139,50 €	1
VSPC 4SL 5VDC R	20 kA, 4 Kanal, Alarm / 5 V DC / 350 mA	8951570000	230,30 €	1
VSPC 4SL 12VDC R	20 kA, 4 Kanal, Alarm / 12 V DC / 300 mA	8951580000	230,30 €	1
VSPC 4SL 24VDC R	20 kA, 4 Kanal, Alarm / 24 V DC / 300 mA	8951590000	230,30 €	1
VSPC 4SL 24VAC R	20 kA, 4 Kanal, Alarm / 24 V AC / 300 mA	8951600000	230,30 €	1
VSPC 2SL 5VDC	20 kA, 2 Kanal / 5 V DC / 300 mA	8924210000	99,60 €	1
VSPC 2SL 12VDC	20 kA, 2 Kanal / 12 V DC / 300 mA	8924230000	99,60 €	1
VSPC 2SL 24VDC	20 kA, 2 Kanal / 24 V DC / 300 mA	8924330000	99,60 €	1
VSPC 2SL 24VAC	20 kA, 2 Kanal / 24 V AC / 300 mA	8924350000	99,60 €	1
VSPC 2SL 48VAC	20 kA, 2 Kanal / 48 V AC / 250 mA	8924370000	99,60 €	1
VSPC 4SL 5VDC	20 kA, 4 Kanal / 5 V DC / 350 mA	8924200000	193,00 €	1
VSPC 4SL 12VDC	20 kA, 4 Kanal / 12 V DC / 300 mA	8924220000	193,00 €	1
VSPC 4SL 24VDC	20 kA, 4 Kanal / 24 V DC / 300 mA	8924320000	193,00 €	1
VSPC 4SL 24VAC	20 kA, 4 Kanal / 24 V AC / 300 mA	8924340000	193,00 €	1
VSPC 4SL 48VAC	20 kA, 4 Kanal / 48 V AC / 250 mA	8924360000	193,00 €	1
VSPC 4SL 60VAC	20 kA, 4 Kanal / 60 V AC / 200 mA	8924380000	193,00 €	1
VSPC BASE 2SL R	2 Kanal, Alarm, Doğrudan Topraklama, Taban	8951770000	42,80 €	1
VSPC BASE 2SL FG R	2 Kanal, Alarm Dolaylı Topraklama, Taban	8951780000	42,80 €	1

Serinin devamı sayfa 130

Aşırı Gerilim Koruma Modülleri



MCZ OVP HF 5V 0,3A



VSPC 1CL 5VDC EX



VDATA CAT6



V-TEST

Tip	Açıklama	Sipariş No	Fiyat/Birim	Ambalaj
VSPC BASE 2SL	2 Kanal, Spark Gap ile Dolaylı, Taban	8924720000	32,00 €	1
VSPC BASE 2SL FG	2 Kanal, Doğrudan Topraklama, Taban	8924280000	37,50 €	1
VSPC BASE 4SL R	4 Kanal, Alarm Doğrudan Topraklama, Taban	8951750000	69,50 €	1
VSPC BASE 4SL FG R	4 Kanal, Alarm Dolaylı Topraklama, Taban	8951760000	69,50 €	1
VSPC BASE 4SL	4 Kanal, Doğrudan Topraklama, Taban	8924700000	58,90 €	1
VSPC BASE 4SL FG	4 Kanal, Spark Gap ile Dolaylı, Taban	8924260000	64,50 €	1

MCZ Serisi Yıldırım Korumalar

MCZ OVP HF 5V 0,3A	5 V UC / 0,3 A	8948620000	211,00 TL	10
MCZ OVP HF 12V 0,3A	12 V UC / 0,3A	8948610000	211,00 TL	10
MCZ OVP HF 24V 0,3A	24 V UC / 0,3 A	8948600000	213,75 TL	10
MCZ OVP CL 24VDC 0,5A	24 V DC / 0,5 A	8448920000	245,45 TL	10
MCZ OVP CL 24VAC 0,5A	24 V AC / 0,5 A	8472880000	205,40 TL	10
MCZ OVP CL 24VUC 1,25A	24 V UC / 1,25 A	8448960000	237,05 TL	10
MCZ OVP CL 48VUC 0,5A	48 V UC / 0,5 A	8449000000	261,30 TL	10
MCZ OVP CL 48VUC 1,25A	48 V UC / 1,25 A	8449040000	317,60 TL	10
MCZ OVP CL FG 24VUC 0,5A	24 V UC / 0,5 A	8704240000	319,05 TL	10
MCZ OVP SL 24VDC 0,5A	24 V DC / 0,5 A	8448940000	242,65 TL	10
MCZ OVP SL 24VUC 1,25A	24 V UC / 1,25 A	8448970000	237,60 TL	10
MCZ OVP SL 48VUC 0,5A	48 V UC / 0,5 A	8449030000	268,25 TL	10
MCZ OVP SL 48VUC 1,25A	48 V UC / 1,25 A	8449050000	277,10 TL	10
MCZ OVP SL FG 24VUC 0,5A	24 V UC / 0,5 A	8823280000	264,55 TL	10
MCZ OVP VARISTOR S10K30	24 V AC / 24 V DC / 16 A	8449140000	145,80 TL	10
MCZ OVP TAZ DIODE 24VDC	24 V DC / 16 A	8449150000	148,10 TL	10
MCZ OVP TAZ DIODE 24VUC	24 V UC / 16 A	8449160000	142,10 TL	10

Varitector - Patlayıcı Ortamlar için Ani Aşırı Gerilim Korumaları

Analog Sinyal Korumaları

VSPC 1CL 5VDC EX	20 kA, 1 Kanal, 5Vdc	8953660000	128,50 €	1
VSPC 1CL 12VDC EX	20 kA, 1 Kanal, 12Vdc	8953590000	128,50 €	1
VSPC 1CL 24VDC EX	20 kA, 1 Kanal, 24Vdc	8953600000	128,50 €	1
VSPC 2CL 24VDC EX	20 kA, 2 Kanal, 24Vdc	8953720000	193,00 €	1
VSPC BASE 1CL FG EX	1 Kanal, Taban	8951810000	53,50 €	1
VSPC BASE 2CL FG EX	2 Kanal, Taban	8951820000	85,70 €	1

Dijital Sinyal Korumaları

VSPC 2SL 12VDC EX	20 kA, 2 Kanal, 12VDC	8953620000	128,50 €	1
VSPC 2SL 24VDC EX	20 kA, 2 Kanal, 24VDC	8953670000	128,50 €	1
VSPC 2SL 48VAC EX	20 kA, 2 Kanal, 48VDC	8953640000	128,50 €	1
VSPC 4SL 12VDC EX	20 kA, 4 Kanal, 12 VDC	1161170000	246,50 €	1
VSPC 4SL 24VDC EX	20 kA, 4 Kanal, 24VDC	1161190000	246,50 €	1
VSPC 4SL 24VAC EX	20 kA, 4 Kanal, 48VAC	1161180000	246,50 €	1
VSPC BASE 2SL FG EX	2 Kanal, Taban	8951830000	53,50 €	1
VSPC BASE 4SL FG EX	4 Kanal, Taban	8951840000	85,70 €	1

Cat 6 RJ45 Aşırı Gerilim Koruma

VDATA CAT6	Data hatları için aşırı gerilim koruma modülü	1348590000	131,00 €	1
------------	---	------------	----------	---

V-Test Cihazları

V-TEST	IEC 62305 PU I ve PU II için	8951860000	1.480,00 €	1
--------	------------------------------	------------	------------	---

Fotovoltaik Sistemler için Ürünler ve Çözümler

Yenilebilir enerji kaynaklarından biri olan fotovoltaik enerji, temiz enerji üretiminin hayati bir unsurudur. Weidmüller fotovoltaik sistemler için yenilikçi çözümlerle verimli ve güvenilir sistemlere sahip olmanız için ürünlerini 25 yıl çalışma prensibi ile üretir.

Weidmüller fotovoltaik sistemler için sürekli genişleyen kapsamlı ürün yelpazesi ile güvenli bir çalışma olanağı sağlar. Fotovoltaik pazarının ihtiyaçlarını karşılamak için tasarlanmış üstün kalitede komponentleri ve geniş bir çözüm yelpazesi ile Weidmüller fotovoltaik sistemlerin verimliliğini artırır.

Müşteriye özel ve bölgenin çevresel şartlarını öngörerek ürünlerini dizayn eder. DC Combiner Boxlarda 10.1 GW kurulum hacmine ulaşmış olan ürünlerini 25 yıl çalışma şartlarına göre dizayn eder. Tüm ürünleriyle 1500 V DC tesis kurulumuna hazırdır. 2017 yılında ürün ailesine katılmış PV-Smart çözümü ile akılcı bir DC Combiner Box dizaynı kullanıcılarının hizmetine sunulmuştur.

Transclinic izleme modülü ile sistem verimliliklerinin izlenmesi ve oluşabilecek kayıpların önceden giderilmesi sağlanır. Weidmüller özgün Push-In teknolojisine sahip olan PV-Stick konnektörler ile sahada hızlı, güvenli ve kolay bağlantıyı garanti eder. El aleti gerektirmeyen bu konnektörler iki şamada kablo bağlantısını gerçekleştirir. İzolasyonu alınmış kabloların konnektör içine ittirilmesi ve rakor mekanizmasının sıkıştırılması montaj için yeterlidir.

Bunun yanı sıra ürün portföyünde bulunan bir diğer konnektör ise WM4C olup, bu konnektör ile hem saha bağlantıları hem de Combiner Box bağlantıları sağlanır.



PV Sistemler için Ürünler ve Çözümler



PV-STICK SET+VPE10



PV-STICK SET



PV-STICK SET+VPE10



BUGH WM4 C BT



WM4C PV
Saha Konnektörleri



SET MULTI-TOOL PV+



TRANSCLINIC 16i+



DC Combiner Box Çözümleri

Tip	Açıklama	Kablo Kesiti	Sipariş No	Fiyat/Birim	Ambalaj
PV SYF Konnektörler					
PV-STICK SET	PV-Stick Erkek-Dişi Set	4mm ² - 6 mm ² kablo kesitine uygun	1422030000	6,20 €	1
PV-STICK SET+VPE10	PV-Stick Dişi 10'lu paket	4mm ² - 6 mm ² kablo kesitine uygun	1303450000	3,10 €	10
PV-STICK SET+VPE10	PV-Stick Erkek 10'lu paket	4mm ² - 6 mm ² kablo kesitine uygun	1303490000	3,10 €	10
PV-STICK SET+VPE50	PV-Stick Dişi 10'lu paket	4mm ² - 6 mm ² kablo kesitine uygun	1303460000	3,05 €	50
PV-STICK SET+VPE50	PV-Stick Erkek 50'lu paket	4mm ² - 6 mm ² kablo kesitine uygun	1303500000	3,05 €	50
PV-STICK SET+VPE200	PV-Stick Dişi 200'lu paket	4mm ² - 6 mm ² kablo kesitine uygun	1303470000	3,05 €	200
PV-STICK SET+VPE200	PV-Stick Erkek 200'lu paket	4mm ² - 6 mm ² kablo kesitine uygun	1303510000	3,05 €	200

WM4C PV Saha Konnektörleri					
BUGH WM4 C BT	Dişi Konnektör	4mm ² - 6 mm ² kablo kesitine uygun	1530690000	0,90 €	100
SFGH WM4 C BT	Erkek Konnektör	4mm ² - 6 mm ² kablo kesitine uygun	1530700000	1,00 €	100
SFKO WM4 C BT	Erkek Kontak	4mm ² - 6 mm ² kablo kesitine uygun	1530680000	0,90 €	100
BUKO WM4 C BT	Dişi Kontak	4mm ² - 6 mm ² kablo kesitine uygun	1530670000	0,90 €	100
SFKO WM4 C BT	Erkek Kontak (Rulo şeklinde gelmektedir)	4mm ² - 6 mm ² kablo kesitine uygun	1530770000	0,85 €	1500
BUKO WM4 C BT	Dişi Kontak (Rulo şeklinde gelmektedir)	4mm ² - 6 mm ² kablo kesitine uygun	1530780000	0,85 €	1500

Hızlı ve Güvenilir Bağlantı / 30A kadar nominal akımlı yükler / TÜV sertifikalı ve en son DIN EN 50521 standartı ile uyumlu / 1530770000 ve 1530780000 Rulo şeklinde gelmektedir

WM4C PV Combiner Box Konnektörleri					
BUGH BOX WM4 C BT	Dişi Konnektör	4mm ² - 6 mm ² kablo kesitine uygun	1530630000	0,90 €	100
SFGH BOX WM4 C BT	Erkek Konnektör	4mm ² - 6 mm ² kablo kesitine uygun	1530640000	0,90 €	100
SFKO WM4 C BT	Erkek Kontak	4mm ² - 6 mm ² kablo kesitine uygun	1530680000	0,90 €	100
BUKO WM4 C BT	Dişi Kontak	4mm ² - 6 mm ² kablo kesitine uygun	1530670000	0,90 €	100

Tip	Açıklama	Sipariş No	Fiyat/Birim	Ambalaj
Aksesuarlar				
SET MULTI-TOOL PV+	Konnektör Sıkıcı	1217280000	14,50 €	1
multi-stripax PV	Kablo Soyucu	1190490000	370,00 €	1
CTF PV WM4	Kontak Sıkma Pensesi	1222870000	417,00 €	1
VSSO WM4 C	Erkek ve Dişi Gövdeleri için Ünsel Toz Kapağı(Toz Tapası)	1254870000	0,65 €	100

İzleme Sistemi					
TRANSCLINIC 16i+	16 String için, 20A DC, 3.20A DC, 1000V DC, RS-485, 2xAl 1xDI	2008130000	840,00 €	1	
TC 16i+ 1K5 (standalone)	TC 16i+ 1K5 (standalone)	2433950000	880,00 €	1	
TC BKE 1k0.4 (standalone)	BKE PV 1000V Güç Kaynağı	7791400746	340,00 €	1	
TC BKE 1k5.4 (standalone)	BKE PV 1500V Güç Kaynağı	7791400879	350,00 €	1	
PV KIT TC 16i+ & TC BKE	1000V 16 String izleme + BKE Güç Kaynağı Paketi	7512000479	1.000,00 €	1	
PV KIT TC 16i+ & TC BKE & SPD	1000V 16 String OVP korumalı izleme + Güç Kaynağı Paketi	7512000498	Sorunuz	Sorunuz	
PV KIT TC 16i+ 1K5 & BKE 1K5.4	1500V 16 String izleme + BKE Güç Kaynağı Paketi	7512000541	Sorunuz	Sorunuz	
PVKITTC 16i+ 1K5 & BKE 1K5.4 & SPD	1500V 16 String OVP korumalı izleme + Güç Kaynağı Paketi	7512000542	Sorunuz	Sorunuz	
PV KIT TC 16i+ 1k5 & SPD	1500V 16 String OVP korumalı izleme	7512000543	Sorunuz	Sorunuz	

DC Combiner Box PV					
DC Combiner Box	Müşteriye özel dizayn Combiner Box	Sorunuz	Sorunuz	Sorunuz	
DC Combiner Box PV-Smart	Müşteriye özel dizayn Combiner Box	Sorunuz	Sorunuz	Sorunuz	
Konnektörlü DC Combiner Box	Müşteriye özel dizayn Combiner Box	Sorunuz	Sorunuz	Sorunuz	
Konnektörlü DC Combiner Box PV-Smart	Müşteriye özel dizayn Combiner Box	Sorunuz	Sorunuz	Sorunuz	

1 String için 30A DC / Modbus RTU over RS-485 / Analog ve Dijital girişler / Şönt Rezistans



VPU II 3 PV 1500V DC



VPU PV II 3 R 1500



WSI 25 10X85 1.5KV, 14x85 gPV

Tip		Sipariş No	Fiyat/Birim	Ambalaj
Koruma Sistemleri				
VPU II 3 PV 1000V DC		1351270000	123,05 €	1
VPU II 3 R PV 1000V DC		1351290000	133,15 €	1
* VPU PV I+II 3 1000	Surge voltage arrester, Low voltage, 1100 V	2530610000	135,90 €	1
* VPU PV II 3 R 1000	Surge voltage arrester, Low voltage, 1100 V, with telecomm. contact, 40 kA	2530180000	72,00 €	1
* VPU PV II 3 1000	Surge voltage arrester, Low voltage, 1100 V, 40 kA	2530550000	64,80 €	1
* VPU PV I+II 3 R 1000	Surge voltage arrester, Low voltage, 1100 V, with telecomm. contact, 40 kA, limp: 6.25 kA	2530620000	146,10 €	1
VPU II 3 PV 1500V DC		1351500000	128,75 €	1
* VPU PV I+II 3 1500	Surge voltage arrester, Low voltage, 1500 V, 30 kA, limp: 5 kA	2530580000	147,30 €	1
* VPU PV I+II 3 R 1500	Surge voltage arrester, Low voltage, 1500 V, with telecomm. contact, 30 kA, limp: 5 kA	2530590000	158,40 €	1
* VPU PV II 3 1500	Surge voltage arrester, Low voltage, 1500 V, 30 kA	2530640000	88,20 €	1
* VPU PV II 3 R 1500	Surge voltage arrester, Low voltage, 1500 V, with telecomm. contact, 30 kA	2530650000	97,20 €	1
Tip	Açıklama	Sipariş No	Fiyat/Birim	Ambalaj
Kablolar				
* PVC-TV1-BK-4-1000	4 mm ² PV Kablosu	1203780000	1,90 €	1000M
* PVC-TV1-BK-6-1000	6 mm ² PV Kablosu	1524740000	2,50 €	1M
Tip	V/A	Sipariş No	Fiyat/Birim	Ambalaj
PV Uygulamalarına Özel 1500V Sigortalı Klemens				
* WSI 25 10X85 1.5KV, 14x85 gPV	1000V (AC) / 1500V (DC) / 32A	2469360000	170,10 TL	5

Ürün Sıralı Listesi

Ürün Kodu	Birim Fiyat	Sayfa No	Ürün Kodu	Birim Fiyat	Sayfa No	Ürün Kodu	Birim Fiyat	Sayfa No	Ürün Kodu	Birim Fiyat	Sayfa No
0100000000			0430600000	9,00 TL	13	0620420000	35,35 TL	30	1018800000	54,95 TL	3
0117500000	39,15 TL	33	0430700000	9,00 TL	4	0631961187	0,400 TL	36	1018840000	18,50 €	96
0119660000	16,25 TL	52	0430700000	9,00 TL	13	0631961203	0,400 TL	36	1019000000	42,05 TL	3
0119760000	16,25 TL	52	0430900000	9,00 TL	4	0632760000	5,55 TL	52	1019100000	64,05 TL	5
0119860000	18,65 TL	52	0430900000	9,00 TL	13	0641720000	40,15 TL	30	1019570000	13,10 €	98
0119960000	19,55 TL	52	0459500000	7,15 TL	30	0648661001	65,00 €	52	1019700000	514,00 TL	3
0120060000	20,60 TL	52	0468660001	0,400 TL	36	0687900000	7,65 TL	52	1020000000	3,60 TL	2
0122800000	63,85 TL	33	0468660051	0,400 TL	36	0697160000	17,70 TL	29	1020080000	3,60 TL	2
0126160000	18,65 TL	52	0468660101	0,400 TL	36	0697360000	3,25 TL	29	1020100000	4,45 TL	2
0126260000	18,65 TL	52	0468660151	0,400 TL	36				1020180000	4,45 TL	2
0137100000	2,20 €	52	0468660201	0,400 TL	36				1020200000	7,55 TL	2
0164000000	16,25 TL	33	0473460001	0,400 TL	36				1020280000	7,55 TL	2
0169900000	3,30 TL	8	0473460051	0,400 TL	36				1020300000	10,25 TL	2
0171111687	0,254 TL	37	0473460101	0,400 TL	36				1020380000	10,25 TL	2
0178100000	16,25 TL	33	0473460151	0,400 TL	36				1020400000	13,85 TL	2
0191860000	7,00 TL	6	0473460201	0,400 TL	36				1020480000	13,85 TL	2
0194300000	2,75 TL	8	0475360000	7,50 TL	30				1020500000	31,10 TL	2
0194400000	3,40 TL	8	0475380000	6,20 TL	30				1020580000	31,10 TL	2
0194500000	4,10 TL	8	0494920000	35,35 TL	33				1021290000	11,00 €	88
									1021320000	11,00 €	88
									1021480000	11,00 €	88
									1021500000	14,10 TL	2
									1021510000	11,00 €	88
									1021580000	14,10 TL	2
									1022300000	46,30 TL	2
									1022600000	58,30 TL	4
									1023300000	58,30 TL	4
									1023400000	58,30 TL	4
									1023500000	58,30 TL	4
									1023600000	81,75 TL	4
									1023700000	4,30 TL	4
									1023780000	4,30 TL	4
									1024140000	240,00 €	37
									1024500000	349,85 TL	2
									1024580000	349,85 TL	2
									1024600000	248,55 TL	2
									1024680000	248,55 TL	2
									1024700000	21,55 TL	2
									1025220000	1,69 TL	38
									1025230000	1,69 TL	38
									1025260000	1,89 TL	39
									1025270000	1,89 TL	39
									1025310000	2,10 TL	39
									1025320000	2,10 TL	39
									1025940015	34,00 €	96
									1025940030	41,50 €	96
									1025940050	53,50 €	96
									1025940100	77,50 €	96
									1025950005	52,50 €	95
									1025950015	58,00 €	95
									1025950030	66,50 €	95
									1025950050	77,50 €	95
									1025950100	106,00 €	95
									1027040000	133,00 €	37
									1027050000	133,00 €	37
									1027060000	133,00 €	37
									1027070000	133,00 €	37
									1027110000	510,00 €	37
									1028300000	109,90 TL	5
									1028380000	109,90 TL	5
									1028400000	153,45 TL	5
									1028480000	153,45 TL	5
									1028500000	219,85 TL	5
									1028580000	219,85 TL	5
									1028600000	301,60 TL	5
									1028680000	301,60 TL	5
									1028700000	357,95 TL	5
									1029900000	39,20 TL	2
									1030200000	37,75 TL	2
									1030700000	31,50 TL	2
									1031100000	30,65 TL	2
0200000000			0500000000			1000000000					
0213760000	16,25 TL	52	0502660000	15,80 TL	30	1002690000	180,00 €	70			
0213811687	0,254 TL	37	0502680000	15,80 TL	30	1002700000	404,50 €	70			
0236400000	76,40 TL	33	0502860000	11,45 TL	30	1002710000	325,50 €	70			
0236500000	78,25 TL	33	0502880000	11,45 TL	30	1002720000	258,50 €	70			
0243520000	59,80 TL	30	0508401694	11,00 €	37	1002730000	247,00 €	70			
025211xxxx	0,254 TL	37	0514200000	39,15 TL	33	1002740000	197,00 €	70			
025261xxxx	0,254 TL	37	0514400000	80,10 TL	33	1002750000	189,00 €	70			
0266500000	10,05 TL	30	0514500000	45,70 TL	33	1002760000	479,00 €	70			
0267200000	15,00 TL	8	0518960001	0,400 TL	36	1003260000	245,00 €	31			
0273820000	10,80 TL	30	0518960011	0,400 TL	36	1010000000	15,05 TL	3			
0273920000	16,25 TL	30	0518960021	0,400 TL	36	1010060000	20,80 €	88			
0274020000	21,95 TL	30	0518960031	0,400 TL	36	1010070000	21,80 €	88			
0274220000	30,10 TL	30	0518960041	0,400 TL	36	1010080000	20,80 €	88			
0274420000	54,55 TL	30	0518960051	0,400 TL	36	1010090000	21,80 €	88			
0274620000	56,85 TL	30	0518960061	0,400 TL	36	1010100000	19,80 TL	3			
0292460000	11,05 TL	38	0518960071	0,400 TL	36	1010200000	26,25 TL	3			
0294360000	17,70 TL	29	0518960081	0,400 TL	36	1010300000	27,20 TL	3			
0294460000	5,50 TL	29	0518960091	0,400 TL	36	1010400000	39,70 TL	3			
0299860000	12,90 TL	30	0522361075	0,400 TL	36	1010500000	63,10 TL	3			
			0522361076	0,400 TL	36	1010680000	25,40 TL	3			
			0522361077	0,400 TL	36	1010780000	25,85 TL	3			
			0523060001	0,400 TL	36	1010880000	29,15 TL	3			
			0523060011	0,400 TL	36	1010980000	34,40 TL	3			
			0523060021	0,400 TL	36	1011000000	24,75 TL	4			
			0523060031	0,400 TL	36	1011300000	60,75 TL	4			
			0523060041	0,400 TL	36	1012200000	60,75 TL	4			
			0523060051	0,400 TL	36	1012300000	60,75 TL	4			
			0523060061	0,400 TL	36	1012400000	60,75 TL	4			
			0523060071	0,400 TL	36	1013680000	7,45 TL	51			
			0523060081	0,400 TL	36	1013690000	11,25 TL	51			
			0523060091	0,400 TL	36	1013710000	14,85 TL	51			
			0525960000	10,80 TL	30	1013720000	18,65 TL	51			
			0525980000	10,80 TL	30	1013730000	22,40 TL	51			
			0531760000	5,55 TL	8	1013740000	26,35 TL	51			
			0545300000	78,00 TL	8	1013750000	30,10 TL	51			
			0546000000	12,90 TL	8	1013760000	33,95 TL	51			
			0550160000	2,60 €	52	1013770000	37,25 TL	51			
			0556660000	20,60 TL	30	1013780000	41,05 TL	51			
			0576261198	0,400 TL	36	1013790000	44,95 TL	51			
			0576261199	0,400 TL	36	1015220000	0,95 €	78			
			0576261202	0,400 TL	36	1015230000	1,05 €	78			

Ürün Kodu	Birim Fiyat	Sayfa No	Ürün Kodu	Birim Fiyat	Sayfa No	Ürün Kodu	Birim Fiyat	Sayfa No	Ürün Kodu	Birim Fiyat	Sayfa No
1031400000	21,55 TL	2	1059660000	37,75 TL	7	1112950000	2,85 TL	38	1133440000	91,80 TL	107
1034400000	25,40 TL	4	1059780000	3.140,00 TL	44	1113561001	90,00 €	109	1133450000	83,85 TL	105
1036100000	23,40 TL	5	1059790000	3.140,00 TL	44	1119030000	234,90 TL	60	1133460000	83,85 TL	105
1036180000	23,40 TL	5	1059800000	3.140,00 TL	44	1119040000	468,20 TL	60	1133470000	91,80 TL	105
1037300000	359,35 TL	3	1059810000	3.140,00 TL	44	1120040000	450,35 TL	57	1133480000	100,60 TL	105
1039900000	39,70 TL	3	1059870000	3.140,00 TL	44	1120040000	450,35 TL	57	1133490000	100,60 TL	105
1040400000	49,75 TL	5	1059880000	3.140,00 TL	44	1120450000	3,80 TL	38	1133510000	100,60 TL	105
1040480000	49,75 TL	5	1060000000	3,90 TL	6	1120470000	3,80 TL	38	1133520000	100,60 TL	105
1041600000	17,70 TL	5	1060080000	3,90 TL	6	1122770000	64,80 TL	108	1133530000	109,00 TL	105
1041610000	55,40 TL	5	1061200000	18,85 TL	5	1122780000	91,25 TL	108	1133540000	117,40 TL	105
1041650000	48,75 TL	5	1061210000	18,85 TL	5	1122810000	120,15 TL	108	1133550000	116,90 TL	105
1041680000	17,70 TL	5	1061210000	18,85 TL	109	1122820000	120,15 TL	108	1133560000	109,00 TL	107
1041900000	20,60 TL	5	1061210000	18,85 TL	111	1122830000	150,40 TL	108	1133570000	125,30 TL	105
1041910000	55,90 TL	5	1062000000	1,49 TL	38	1122840000	150,40 TL	108	1133580000	125,30 TL	105
1041950000	48,25 TL	5	1062010000	1,49 TL	38	1122850000	195,00 TL	108	1133590000	142,10 TL	105
1041980000	20,60 TL	5	1062050000	1,62 TL	39	1122880000	64,00 TL	109	1133600000	150,40 TL	105
1042400000	34,40 TL	2	1062070000	1,62 TL	39	1122890000	91,25 TL	109	1133610000	150,40 TL	105
1042600000	9,60 TL	4	1062660000	21,80 TL	7	1122920000	120,15 TL	109	1133620000	166,80 TL	105
1042680000	9,60 TL	5	1062670000	25,85 TL	7	1122930000	120,15 TL	109	1133630000	166,80 TL	105
1042700000	35,90 TL	5	1062680000	29,65 TL	7	1122940000	150,40 TL	109	1133640000	183,95 TL	105
1044470010	60,00 €	96	1063300000	183,55 TL	7	1122950000	150,40 TL	109	1133650000	200,35 TL	105
1044470015	63,50 €	96	1063400000	257,10 TL	7	1122970000	186,30 TL	109	1133660000	200,35 TL	105
1044470030	71,00 €	96	1063500000	151,95 TL	7	1123490000	102,00 TL	109	1133760000	67,10 TL	107
1044470050	83,00 €	96	1063600000	246,60 TL	7	1123500000	117,40 TL	109	1133780000	75,45 TL	107
1044470100	110,00 €	96	1064460000	17,70 TL	6	1123530000	124,80 TL	109	1133800000	75,45 TL	107
1050000000	3,30 TL	5	1064480000	17,70 TL	6	1123540000	124,80 TL	109	1133810000	83,85 TL	107
1050080000	3,30 TL	5	1064560000	21,05 TL	6	1123550000	154,15 TL	109	1133820000	91,80 TL	107
1050100000	4,70 TL	6	1064580000	21,05 TL	6	1123570000	154,15 TL	109	1133830000	91,80 TL	107
1050180000	4,70 TL	6	1064660000	25,40 TL	6	1123580000	194,25 TL	109	1133840000	91,80 TL	105
1050280000	7,30 TL	6	1064680000	25,40 TL	6	1126940000	133,20 TL	110	1133850000	100,60 TL	105
1051960000	9,05 TL	7	1064760000	38,95 TL	6	1126950000	148,10 TL	110	1133860000	100,60 TL	105
1052060000	40,55 TL	7	1064780000	38,95 TL	6	1126980000	172,80 TL	110	1133870000	109,00 TL	105
1052100000	1,10 TL	8	1066850000	71,00 €	95	1126990000	172,80 TL	110	1133880000	116,90 TL	105
1052260000	40,55 TL	7	1066860000	75,00 €	95	1127000000	203,05 TL	110	1133890000	116,90 TL	105
1052360000	9,05 TL	7	1066870000	90,50 €	95	1127010000	203,05 TL	110	1133910000	142,10 TL	105
1052460000	46,25 TL	7	1066880000	118,00 €	95	1127020000	247,80 TL	110	1133920000	150,40 TL	105
1052560000	10,05 TL	7	1067250000	372,00 €	114	1127170000	139,70 TL	110	1133930000	150,40 TL	105
1053060000	16,65 TL	7	1067800000	6,00 TL	6	1127180000	204,95 TL	110	1133940000	183,95 TL	105
1053160000	76,00 TL	7	1068300000	5,75 TL	6	1127210000	225,45 TL	111	1133950000	200,35 TL	105
1053260000	12,15 TL	7	1068400000	9,05 TL	6	1127220000	225,45 TL	111	1133960000	200,35 TL	105
1053360000	50,65 TL	7	1074600000	6,15 TL	6	1127230000	255,20 TL	111	1134160000	4,20 TL	107
1053660000	7,15 TL	6	1079200000	24,85 TL	7	1127240000	255,20 TL	111	11337530000	1.755,00 €	60
1053760000	10,05 TL	6	1079300000	34,90 TL	7	1127250000	311,60 TL	110	1137780000	249,00 TL	4
1053860000	11,00 TL	6	1079400000	49,25 TL	7	1127410000	190,00 TL	111	1137790000	134,30 TL	4
1053960000	12,90 TL	6	1079920000	1.257,00 TL	57	1127420000	205,40 TL	111	1138400000	15,45 TL	43
1054060000	14,85 TL	6	1079920000	1.257,00 TL	57	1127450000	225,45 TL	111	1138420000	15,45 TL	43
1054160000	17,15 TL	6	1079930000	878,00 TL	57	1127470000	225,45 TL	111	1138430000	18,10 TL	43
1054260000	19,55 TL	6	1079930000	878,00 TL	57	1127480000	255,20 TL	111	1138450000	18,10 TL	43
1054360000	21,95 TL	6	1083040000	30,10 TL	26	1127490000	255,20 TL	111	1139330000	33,30 €	88
1054460000	27,20 TL	6	1083050000	56,35 TL	26	1127500000	311,60 TL	111	1139880000	636,00 €	37
1054560000	13,35 TL	7	1083230000	4,30 TL	40	1127630000	226,80 TL	111	1140640000	90,10 €	89
1054660000	17,15 TL	7	1083240000	4,30 TL	40	1127640000	355,85 TL	111	1140650000	83,55 €	89
1054760000	13,25 TL	7	1084000000	7,00 TL	6	1127680000	226,80 TL	111	1142990000	7,85 TL	10
1054860000	17,15 TL	7	1084080000	7,00 TL	6	1127690000	355,85 TL	111	1143000000	49,75 TL	9
1054960000	14,30 TL	7	1084780000	45,85 TL	26	1131380000	10,80 €	98	1143010000	92,25 TL	9
1055060000	21,05 TL	7	1084790000	32,45 TL	26	1131740000	62,10 TL	12	1143020000	44,00 TL	9
1055160000	16,65 TL	7				1131750000	55,90 TL	12	1143030000	78,45 TL	9
1055260000	22,40 TL	7				1131760000	55,90 TL	12	1143050000	20,60 TL	9
1055360000	22,40 TL	7				1132040000	19,50 €	96	1143070000	12,00 TL	9
1055460000	32,00 TL	7				1132050000	19,50 €	96	1157820000	589,00 TL	60
1057160000	22,75 TL	7				1132060000	19,50 €	96	1157830000	730,00 TL	60
1057260000	26,35 TL	7				1132810000	25,60 TL	107	1161170000	246,50 €	130
1057860000	19,10 TL	7				1132820000	25,60 TL	107	1161180000	246,50 €	130
1058800000	23,40 TL	6				1133360000	68,05 TL	107	1161190000	246,50 €	130
1059000000	30,10 TL	5				1133370000	68,05 TL	107	1161870000	72,90 €	89
1059100000	6,35 TL	6				1133380000	75,45 TL	107	1161880000	79,50 €	89
1059180000	6,35 TL	6				1133390000	83,85 TL	107	1162610000	5,75 TL	5
1059330015	58,00 €	96				1133400000	100,60 TL	107	1162620000	5,75 TL	14
1059330030	66,50 €	96				1133410000	75,45 TL	107	1162820000	119,45 TL	9
1059330050	77,50 €	96				1133420000	75,45 TL	107	1162830000	208,30 TL	9
1059330100	106,00 €	96				1133430000	83,85 TL	107	1162840000	208,30 TL	9

Ürün Sıralı Listesi

Ürün Kodu	Birim Fiyat	Sayfa No	Ürün Kodu	Birim Fiyat	Sayfa No	Ürün Kodu	Birim Fiyat	Sayfa No	Ürün Kodu	Birim Fiyat	Sayfa No
1162850000	208,30 TL	9	1176020000	331,00 €	116	1202460000	30,75 €	125	1219960000	161,10 TL	107
1162860000	208,30 TL	9	1176030000	314,95 €	116	1202470000	35,50 €	126	1219970000	177,95 TL	107
1162920000	66,90 TL	9	1176040000	168,00 €	116	1202480000	35,50 €	126	1219980000	177,95 TL	107
1162930000	103,20 TL	9	1176050000	329,50 €	116	1202510000	35,50 €	126	1219990000	177,95 TL	107
1162940000	103,70 TL	9	1176070000	180,00 €	116	1202520000	78,30 €	126	1220010000	177,95 TL	107
1162950000	103,70 TL	9	1176080000	329,50 €	116	1202530000	78,30 €	126	1220020000	177,95 TL	107
1162960000	103,20 TL	9	1180800000	61,50 TL	101	1202540000	78,30 €	126	1220030000	177,95 TL	107
1162980000	86,00 TL	9	1181100000	47,50 TL	101	1202550000	110,50 €	126	1220040000	161,10 TL	107
1162990000	156,25 TL	9	1185060000	18,65 TL	52	1202560000	110,50 €	126	1220050000	161,10 TL	107
1163000000	156,25 TL	9	1186720000	14,20 TL	6	1202580000	30,75 €	125	1220060000	170,05 TL	107
1163010000	156,25 TL	9	1186730000	14,20 TL	6	1202590000	30,75 €	125	1220070000	186,30 TL	108
1163020000	156,25 TL	9	1186740000	49,75 TL	2	1202610000	21,25 €	125	1220080000	186,30 TL	108
1163040000	98,90 TL	9	1186750000	49,75 TL	2	1202620000	21,25 €	125	1220090000	186,30 TL	108
1163050000	187,40 TL	9	1190490000	370,00 €	132	1202630000	21,25 €	125	1220110000	186,30 TL	108
1163060000	188,30 TL	9	1193680000	23,75 TL	109	1202640000	21,25 €	125	1220120000	186,30 TL	108
1163070000	188,30 TL	9	1193680000	23,75 TL	111	1203780000	1,90 €	133	1220130000	186,30 TL	108
1163080000	187,85 TL	9	1193690000	44,20 TL	109	1203900000	58,25 TL	54	1220140000	161,10 TL	108
1165320000	8,45 TL	27	1193690000	44,20 TL	111	1204100000	58,25 TL	54	1220150000	161,10 TL	108
1165820000	45,60 €	126	1193700000	46,60 TL	109	1205000000	104,35 TL	54	1220170000	169,55 TL	108
1165830000	45,60 €	126	1193700000	46,60 TL	111	1205000000	104,35 TL	56	1220180000	186,30 TL	108
1165840000	45,60 €	126	1194560000	484,00 €	69	1207500000	87,10 TL	54	1220190000	186,30 TL	108
1165850000	45,60 €	126	1194610000	571,00 €	69	1207500000	87,10 TL	55	1220200000	186,30 TL	108
1165870000	51,70 €	126	1194660000	633,00 €	69	1207700000	87,10 TL	54	1220210000	186,30 TL	108
1165880000	51,70 €	126	1194710000	610,00 €	69	1207700000	87,10 TL	55	1220220000	186,30 TL	108
1165890000	51,70 €	126	1194760000	670,00 €	69	1208600000	104,35 TL	54	1220230000	186,30 TL	108
1165940010	5,50 €	95	1194810000	618,00 €	69	1208600000	104,35 TL	56	1220250000	50,30 TL	106
1165940020	7,30 €	95	1194860000	695,00 €	70	1208600000	104,35 TL	57	1220250000	50,30 TL	108
1165940030	9,15 €	95	1194910000	674,00 €	70	1208920000	59,25 TL	12	1220260000	4,20 TL	106
1165940040	11,60 €	95	1194960000	764,00 €	70	1210410000	5,55 TL	15	1220260000	4,20 TL	108
1165940050	13,10 €	95	1195010000	793,00 €	70	1211100000	124,35 TL	55	1220260000	60,20 TL	26
1165940200	41,60 €	95	1195060000	850,00 €	70	1211300000	124,35 TL	55	1221350000	68,40 TL	26
1173220000	72,90 €	89	1195110000	916,00 €	70	1211450000	4,80 TL	28	1221360000	8,10 TL	27
1173240000	79,50 €	89	1195160000	1.064,00 €	70	1211460000	7,30 TL	28	1222210000	93,50 €	122
1173620000	344,10 TL	28	1195210000	982,00 €	70	1212400000	117,85 TL	55	1222220000	117,00 €	122
1173630000	23,75 TL	28	1195260000	982,00 €	70	1212400000	117,85 TL	56	1222240000	63,50 €	122
1173650000	344,10 TL	28	1195310000	1.204,00 €	70	1215700000	96,85 TL	55	1222550000	18,50 €	96
1173670000	9,60 TL	28	1195360000	1.282,00 €	70	1216100000	99,20 TL	55	1222870000	417,00 €	132
1173680000	344,10 TL	28	1195410000	1.380,00 €	70	1217280000	14,50 €	132	1226220000	10,65 TL	44
1173700000	6,00 TL	28	1195460000	1.619,00 €	70	1217800000	233,35 TL	55	1230050000	15,00 TL	28
1173710000	344,10 TL	28	1195510000	1.877,00 €	70	1217800000	233,35 TL	57	1230060000	15,00 TL	28
1173720000	7,30 TL	28	1195560000	1.914,00 €	70	1219350000	150,40 TL	106	1230070000	15,00 TL	28
1173740000	157,70 TL	28	1195610000	2.108,00 €	70	1219360000	150,40 TL	106	1230080000	15,00 TL	28
1173750000	4,80 TL	28	1199860000	448,50 €	70	1219370000	150,40 TL	106	1230090000	15,30 TL	28
1173780000	157,70 TL	28	1199910000	617,00 €	70	1219380000	177,95 TL	106	1230110000	15,30 TL	28
1173790000	157,70 TL	28	1199960000	657,00 €	70	1219390000	183,95 TL	106	1230120000	29,65 TL	28
1173800000	157,70 TL	28				1219410000	166,80 TL	106	1230130000	29,65 TL	28
1173810000	81,75 TL	28				1219420000	166,80 TL	106	1230140000	29,65 TL	28
1173820000	81,75 TL	28				1219430000	166,80 TL	106	1238060000	3,50 TL	51
1173830000	81,75 TL	28				1219440000	166,80 TL	106	1238160000	5,40 TL	51
1173840000	81,75 TL	28				1219450000	208,65 TL	106	1238260000	5,35 TL	51
1173850000	169,20 TL	28				1219730000	153,20 TL	106	1238360000	6,75 TL	51
1173870000	169,20 TL	28				1219740000	153,20 TL	106	1238460000	9,50 TL	51
1173880000	87,50 TL	28				1219750000	161,60 TL	106	1238560000	11,00 TL	51
1173890000	89,85 TL	28				1219760000	150,40 TL	106	1238660000	10,55 TL	51
1173900000	157,70 TL	28				1219770000	177,95 TL	106	1238760000	12,00 TL	51
1173910000	157,70 TL	28				1219780000	142,10 TL	106	1238860000	16,00 TL	51
1173920000	81,75 TL	28				1219790000	142,10 TL	106	1238960000	14,85 TL	51
1173930000	81,75 TL	28				1219810000	150,40 TL	106	1239060000	16,25 TL	51
1174650000	25,60 TL	106				1219820000	166,80 TL	106	1239560000	2,70 TL	51
1174650000	25,60 TL	106				1219830000	166,80 TL	106	1239660000	4,10 TL	51
1174650000	25,60 TL	107				1219840000	153,20 TL	107	1239760000	6,60 TL	51
1174650000	25,60 TL	108				1219850000	153,20 TL	107	1239860000	8,50 TL	51
1174670000	25,60 TL	106				1219860000	161,10 TL	107	1239960000	9,50 TL	51
1174670000	25,60 TL	106				1219870000	177,00 TL	107	1240060000	11,00 TL	51
1174670000	25,60 TL	107				1219880000	177,00 TL	107	1240160000	10,55 TL	51
1174670000	25,60 TL	108				1219890000	177,00 TL	107	1240260000	12,00 TL	51
1175850000	13,65 TL	43				1219910000	177,00 TL	107	1240360000	13,35 TL	51
1175980000	155,75 €	116				1219920000	177,00 TL	107	1240460000	14,85 TL	51
1175990000	265,00 €	116				1219930000	177,00 TL	107	1240560000	16,25 TL	51
1176000000	206,00 €	116				1219940000	153,20 TL	107	1240780000	68,05 TL	109
1176010000	173,50 €	116				1219950000	153,20 TL	107	1240780000	68,05 TL	111
			1200000000								
			1200000000	58,25 TL	54						
			1200020000	640,00 €	70						
			1200070000	684,00 €	70						
			1200120000	715,00 €	70						
			1200170000	755,00 €	70						
			1200200000	58,25 TL	54						
			1200230000	804,00 €	70						
			1200280000	846,00 €	70						
			1200340000	813,00 €	70						
			1200390000	850,00 €	70						
			1200450000	930,00 €	70						
			1200510000	1.064,00 €	70						
			1200560000	1.076,00 €	70						
			1200620000	1.076,00 €	70						
			1200670000	1.225,00 €	70						
			1200730000	1.281,00 €	70						
			1200780000	1.380,00 €	70						
			1200840000	1.619,00 €	70						
			1200890000	1.878,00 €	70						
			1200950000	1.915,00 €	70						
			1201010000	2.108,00 €	70						
			1202100000	68,45 TL	54						
			1202100000	68,45 TL	55						
			1202450000	30,75 €	125						

Ürün Kodu	Birim Fiyat	Sayfa No	Ürün Kodu	Birim Fiyat	Sayfa No	Ürün Kodu	Birim Fiyat	Sayfa No	Ürün Kodu	Birim Fiyat	Sayfa No
1240800000	7,95 TL	109	1251110000	435,75 €	123	1286860000	686,00 €	92	1315550000	108,00 €	80
1240800000	7,95 TL	111	1251220000	278,00 €	123	1286870000	847,00 €	92	1315570000	176,50 €	81
1240840000	163,80 €	92	1254870000	0,65 €	132	1286920000	609,00 €	92	1315580000	197,50 €	81
1240850000	185,65 €	92	1261300000	7,15 TL	30	1286930000	2.097,00 €	93	1315590000	200,00 €	81
1240870000	458,50 €	92	1267790000	344,10 TL	28	1286940000	2.097,00 €	93	1315600000	195,00 €	81
1240880000	280,00 €	92	1267800000	344,10 TL	28	1286970000	2.925,00 €	93	1315610000	228,00 €	81
1240890000	280,00 €	92	1267810000	344,10 TL	28	1286990000	3.546,00 €	93	1315620000	217,00 €	80
1240900000	207,50 €	92	1267820000	344,10 TL	28	1287000000	3.546,00 €	94	1315650000	225,00 €	81
1240910000	502,00 €	92	1267830000	157,70 TL	28	1287010000	3.872,00 €	94	1315670000	227,50 €	81
1240920000	524,00 €	92	1267840000	157,70 TL	28	1287020000	2.733,00 €	94	1315680000	255,00 €	81
1240930000	459,00 €	92	1267870000	169,20 TL	28	1289200000	0,450 TL	77	1315690000	244,00 €	80
1240940000	928,00 €	93	1267880000	169,20 TL	28	1289400000	0,645 TL	77	1315700000	216,00 €	81
1240950000	515,00 €	92	1267890000	81,75 TL	28	1296000000	548,00 TL	61	1315710000	228,00 €	81
1240970000	1.889,00 €	93	1267900000	81,75 TL	28	1300000000			1315720000	259,00 €	81
1240980000	972,00 €	92	1267910000	87,50 TL	28	1302920000	350,00 €	37	1315730000	277,00 €	81
1240990000	1.354,00 €	93	1267920000	87,50 TL	28	1303360000	43,45 TL	29	1315740000	220,00 €	81
1241000000	743,00 €	92	1268360000	649,00 TL	58	1303450000	3,10 €	132	1315750000	230,00 €	81
1241020000	2.140,00 €	93	1270040000	12,00 TL	9	1303460000	3,05 €	132	1315770000	26,50 €	82
1241030000	1.059,00 €	92	1270070000	44,00 TL	9	1303470000	3,05 €	132	1318061198	0,400 TL	36
1241040000	1.158,00 €	93	1270080000	78,45 TL	9	1303490000	3,10 €	132	1318061199	0,400 TL	36
1241050000	1.059,00 €	92	1274660000	126,35 TL	62	1303500000	3,05 €	132	1318061202	0,400 TL	36
1241070000	1.736,00 €	93	1274670000	149,05 TL	62	1303510000	3,05 €	132	1318220000	361,00 €	115
1241080000	1.736,00 €	93	1274680000	179,80 TL	62	1303570000	130,50 €	112	1318640000	1,35 TL	39
1241090000	2.217,00 €	93	1274690000	234,90 TL	62	1303890000	96,50 €	112	1318650000	1,42 TL	39
1241100000	2.053,00 €	93	1274710000	166,85 TL	62	1304040000	163,00 €	112	1318660000	1,49 TL	39
1241120000	2.588,00 €	93	1274720000	225,20 TL	62	1305360000	131,35 TL	58	1318670000	1,49 TL	39
1241130000	2.588,00 €	93	1274730000	192,80 TL	62	1305760000	81,95 TL	58	1318680000	1,55 TL	39
1241270000	677,00 €	92	1274740000	267,30 TL	62	1305810000	27,50 €	68	1318690000	1,62 TL	39
1241280000	786,00 €	92	1274750000	865,00 TL	62	1305820000	28,80 €	68	1318710000	1,49 TL	39
1241290000	1.813,00 €	93	1275100000	166,80 TL	110	1305830000	32,70 €	68	1318720000	1,49 TL	40
1241300000	1.813,00 €	93	1276960001	0,440 TL	36	1305840000	37,95 €	68	1318730000	1,55 TL	40
1241320000	2.533,00 €	93	1276960011	0,440 TL	36	1305850000	40,60 €	68	1318740000	1,55 TL	40
1241330000	3.069,00 €	93	1276960021	0,440 TL	36	1305870000	43,20 €	68	1318750000	1,62 TL	40
1241340000	3.069,00 €	93	1276960031	0,440 TL	36	1305880000	49,70 €	68	1318760000	1,55 TL	40
1241350000	3.352,00 €	94	1276960041	0,440 TL	36	1305890000	53,65 €	68	1319270000	155,50 €	112
1241370000	3.330,00 €	94	1278700000	0,118 TL	77	1305900000	75,90 €	68	1319280000	155,50 €	112
1241380000	502,00 €	92	1278800000	0,199 TL	77	1305910000	90,30 €	68	1320060000	9,40 TL	51
1241390000	1.889,00 €	94	1278900000	0,318 TL	77	1305920000	149,00 €	68	1320160000	14,30 TL	51
1241400000	448,00 €	95	1279000000	0,389 TL	77	1305930000	116,50 €	68	1324260000	14,30 TL	52
1241410000	448,00 €	95	1279100000	0,849 TL	77	1305940000	142,50 €	68	1324380000	5.400,00 €	37
1241420000	699,00 €	95	1281760000	8,10 TL	51	1305940000	142,50 €	68	1324460000	16,25 TL	52
1241430000	131,00 €	93	1281860000	12,00 TL	51	1305950000	204,00 €	68	1327600000	47,70 TL	43
1241430000	131,00 €	94	1281960000	20,00 TL	51	1305970000	173,00 €	68	1327620000	71,70 TL	43
1241490000	284,00 €	94	1282060000	22,00 TL	51	1305980000	149,00 €	68	1327630000	9,45 TL	43
1241500000	457,00 €	94	1282160000	30,00 TL	51	1305990000	196,00 €	68	1327640000	13,25 TL	43
1241510000	502,00 €	94	1282260000	35,00 TL	51	1312160005	4,80 €	95	1327650000	29,85 TL	43
1241520000	1.540,00 €	94	1282360000	37,00 TL	51	1312160010	5,95 €	95	1327670000	38,40 TL	43
1242080000	437,00 €	94	1282460000	40,00 TL	51	1312160020	7,70 €	95	1327680000	23,35 TL	44
1242090000	531,00 €	94	1282490000	57,00 €	115	1312160030	9,65 €	95	1327690000	29,45 TL	43
1247290000	55,90 TL	3	1282560000	50,00 TL	51	1312160050	13,50 €	95	1327700000	11,70 TL	43
1247290000	55,90 TL	9	1282660000	52,00 TL	52	1312160100	23,90 €	95	1327720000	16,25 TL	43
1247310000	63,10 TL	3	1282760000	55,00 TL	52	1315170000	43,00 €	80	1327730000	9,70 TL	43
1247310000	63,10 TL	9	1282820000	364,65 TL	57	1315180000	65,00 €	80	1327740000	14,30 TL	43
1247420000	89,85 TL	3	1282820000	364,65 TL	57	1315190000	56,00 €	80	1327750000	11,70 TL	43
1247420000	89,85 TL	9	1286480000	1.242,00 €	95	1315200000	95,00 €	80	1327770000	15,45 TL	43
1247430000	99,35 TL	3	1286530000	529,00 €	92	1315210000	113,50 €	80	1327780000	14,30 TL	43
1247430000	99,35 TL	9	1286540000	316,50 €	92	1315220000	48,50 €	80	1327790000	17,90 TL	43
1248580000	5,60 TL	42	1286550000	316,50 €	92	1315230000	78,00 €	80	1327800000	47,70 TL	43
1248590000	5,60 TL	42	1286560000	240,00 €	92	1315240000	75,00 €	80	1327820000	71,70 TL	43
1248610000	5,60 TL	42	1286570000	533,00 €	92	1315250000	114,00 €	80	1327830000	29,85 TL	43
1248620000	7,70 TL	42	1286580000	602,00 €	92	1315270000	132,00 €	80	1327840000	38,40 TL	43
1248630000	7,70 TL	42	1286590000	900,00 €	92	1315350000	56,00 €	80	1327850000	23,35 TL	43
1248640000	7,70 TL	42	1286610000	1.292,00 €	92	1315370000	80,00 €	80	1327870000	29,45 TL	43
1248650000	11,20 TL	42	1286620000	1.292,00 €	92	1315390000	107,00 €	80	1327880000	11,70 TL	43
1248660000	11,20 TL	42	1286780000	1.318,00 €	93	1315400000	114,00 €	80	1327890000	16,25 TL	43
1248670000	11,20 TL	42	1286790000	2.006,00 €	93	1315410000	62,00 €	80	1327900000	9,70 TL	43
1250360000	10,25 TL	52	1286800000	2.006,00 €	93	1315420000	93,00 €	80	1327920000	14,30 TL	43
1250370000	12,90 TL	52	1286810000	2.559,00 €	93	1315430000	90,00 €	80	1331600000	900,00 €	37
1251070000	192,90 €	123	1286820000	2.370,00 €	93	1315440000	108,00 €	80	1333100000	0,138 TL	71
1251080000	230,50 €	123	1286830000	2.988,00 €	93	1315450000	132,00 €	80	1334490000	910,00 €	115
1251090000	320,80 €	123	1286840000	2.988,00 €	93	1315540000	123,50 €	80	1334710000	43,00 €	81

Ürün Sıralı Listesi

Ürün Kodu	Birim Fiyat	Sayfa No	Ürün Kodu	Birim Fiyat	Sayfa No	Ürün Kodu	Birim Fiyat	Sayfa No	Ürün Kodu	Birim Fiyat	Sayfa No
1334740000	43,00 €	81	1351780000	680,00 €	128	1423410000	1.416,00 TL	48	1478230000	210,00 €	122
1334770000	32,00 €	82	1351920000	180,00 €	128	1423550000	417,00 €	120	1478240000	220,00 €	122
1334780000	32,00 €	82	1352130000	69,50 €	128	1426210000	143,50 €	37	1478250000	420,00 €	122
1334790000	32,00 €	82	1352140000	80,00 €	128	1428780000	514,00 €	129	1478270000	630,00 €	122
1334800000	32,00 €	82	1352150000	128,50 €	128	1435590000	192,00 €	116	1479650000	112,70 TL	108
1334810000	32,00 €	82	1352170000	150,00 €	128	1435610000	146,50 €	116	1479670000	113,65 TL	108
1334870000	335,00 €	80	1352180000	257,00 €	128	1444050000	2.233,00 TL	60	1479680000	111,30 TL	108
1334880000	390,00 €	80	1352190000	289,00 €	128	1445070000	2.974,00 TL	60	1479690000	129,45 TL	108
1334890000	397,00 €	80	1352200000	193,00 €	128	1445080000	2.444,00 TL	60	1479700000	129,45 TL	108
1334900000	397,00 €	80	1352220000	225,00 €	128	1445930000	926,00 TL	62	1479710000	131,75 TL	108
1334910000	358,00 €	80	1352230000	364,00 €	128	1450510000	31,00 €	98	1479730000	137,35 TL	108
1334920000	390,00 €	80	1352240000	396,00 €	128	1450520000	43,50 €	98	1479740000	137,35 TL	108
1334930000	390,00 €	80	1352580000	37,50 €	128	1450530000	39,00 €	98	1479750000	168,60 TL	108
1334940000	380,00 €	80	1352590000	42,90 €	128	1450540000	52,00 €	98	1479760000	164,90 TL	108
1335030000	227,50 €	81	1352600000	75,00 €	128	1450550000	27,00 €	98	1479770000	203,05 TL	108
1335040000	260,00 €	81	1352620000	85,70 €	128	1450570000	27,50 €	98	1479780000	128,05 TL	108
1335050000	245,00 €	81	1352630000	75,00 €	128	1450580000	27,50 €	98	1479790000	220,80 TL	108
1335060000	328,00 €	81	1352640000	85,70 €	128	1450590000	27,50 €	98	1479810000	152,75 TL	108
1335070000	259,00 €	81	1352650000	155,50 €	128	1450600000	27,50 €	98	1479830000	244,95 TL	108
1335140000	724,00 TL	115	1352670000	171,50 €	128	1450610000	27,50 €	98	1481970000	361,00 €	114
1338650000	153,75 €	37	1352680000	128,50 €	128	1450620000	27,50 €	98	1481980000	284,50 €	118
1338670000	153,75 €	37	1352690000	171,50 €	128	1450630000	12,00 €	98	1481990000	284,50 €	118
1338680000	153,75 €	37	1352700000	101,75 €	128	1450640000	12,10 €	98	1482000000	267,50 €	118
1338690000	153,75 €	37	1352720000	128,50 €	128	1450650000	12,10 €	98	1482010000	267,50 €	118
1338710000	261,50 €	37	1362950000	374,00 €	94	1450670000	12,10 €	98	1482020000	267,50 €	118
1338720000	564,00 €	37	1367090000	385,00 €	95	1450680000	12,10 €	98	1482030000	41,50 €	118
1339610000	51,00 €	96	1367100000	135,00 €	95	1450690000	12,10 €	98	1482040000	41,50 €	118
1339920000	1,50 €	82	1367110000	125,00 €	95	1450700000	12,10 €	98	1482050000	69,00 €	118
1341030000	1.335,00 TL	44	1367120000	400,00 €	94	1450730000	17,50 €	98	1482070000	69,00 €	118
1341040000	1.335,00 TL	44	1367120000	400,00 €	95	1450770000	19,00 €	98	1482080000	72,50 €	118
1341050000	1.335,00 TL	44	1367130000	310,00 €	95	1450840000	5,50 €	98	1482140000	76,00 €	118
1341070000	1.335,00 TL	44	1367140000	281,00 €	95	1450850000	5,50 €	98	1482150000	114,00 €	118
1341080000	1.335,00 TL	44	1370040010	478,00 €	123	1450870000	4,80 €	98	1482170000	76,00 €	118
1341090000	1.335,00 TL	44	1370050010	282,00 €	123	1450880000	7,20 €	98	1482180000	76,00 €	118
1341100000	1.335,00 TL	44	1372460000	18,65 TL	51	1450890000	7,20 €	98	1482220000	76,00 €	118
1341110000	1.335,00 TL	44	1372660000	28,20 TL	51	1450900000	6,40 €	98	1487920000	17,50 €	98
1341120000	2.002,00 TL	44	1375450000	186,00 €	116	1453210000	300,70 €	114	1489940000	1.279,00 €	94
1341130000	4,45 TL	44	1375470000	300,00 €	116	1460140000	74,00 €	80	1491160000	162,00 €	94
1341140000	1,89 TL	44	1375480000	155,70 €	116	1460150000	167,00 €	80	1491180000	51,00 €	94
1341150000	3,30 TL	44	1375510000	139,70 €	116	1463530000	470,00 TL	109	1491190000	57,00 €	94
1341170000	2,70 TL	44	1375520000	120,70 €	116	1463540000	490,00 TL	109	1491210000	66,00 €	94
1341180000	2,85 TL	44	1394390000	195,00 €	81	1463550000	630,00 TL	109	1498700000	192,85 TL	57
1341620000	0,540 TL	37	1394400000	65,00 €	80	1468880000	914,00 TL	60	1498700000	192,85 TL	57
1341630000	0,671 TL	82	1394420000	111,00 €	80	1469340000	3,75 €	82	1498800000	192,85 TL	57
1344760000	374,00 €	94				1469470000	73,45 €	122	1498900000	217,95 TL	57
1344770000	1.419,00 €	93				1469480000	96,90 €	122	1498900000	217,95 TL	57
1345240000	2.122,00 €	93				1469490000	173,40 €	122	1499000000	217,95 TL	57
1345250000	2.132,00 €	94				1469510000	235,00 €	122			
1345270000	1.580,00 €	94				1469520000	459,00 €	122			
1345310000	12.870,00 TL	65				1469530000	130,00 €	122			
1345320000	18.332,00 TL	65				1469540000	180,00 €	122			
1345330000	3.140,00 TL	65				1469550000	255,00 €	122			
1346610000	10,00 €	82				1469560000	460,00 €	122			
1348590000	131,00 €	96				1469570000	80,00 €	122			
1348590000	131,00 €	130				1469580000	130,00 €	122			
1351270000	123,05 €	133				1469590000	120,00 €	122			
1351290000	133,15 €	133				1469610000	240,00 €	122			
1351350000	259,00 €	128				1470260000	466,00 €	120			
1351500000	128,75 €	133				1477420000	240,50 €	114			
1351550000	69,50 €	128				1478100000	120,00 €	122			
1351570000	195,00 €	128				1478110000	153,00 €	122			
1351580000	69,50 €	128				1478120000	190,00 €	122			
1351600000	69,50 €	128				1478130000	255,00 €	122			
1351630000	69,50 €	128				1478140000	367,00 €	122			
1351650000	69,50 €	128				1478150000	590,00 €	122			
1351670000	558,00 €	128				1478170000	250,00 €	122			
1351680000	53,50 €	128				1478180000	290,00 €	122			
1351690000	509,00 €	128				1478190000	380,00 €	122			
1351700000	53,50 €	128				1478200000	630,00 €	122			
1351740000	346,50 €	128				1478210000	105,00 €	122			
1351770000	737,00 €	128				1478220000	140,00 €	122			

Ürün Sıralı Listesi

Ürün Kodu	Birim Fiyat	Sayfa No	Ürün Kodu	Birim Fiyat	Sayfa No	Ürün Kodu	Birim Fiyat	Sayfa No	Ürün Kodu	Birim Fiyat	Sayfa No
1608970000	8,15 TL	16	1651210000	144,85 TL	56	1680411044	1,12 TL	40	1699940000	2,50 €	77
1608980000	12,10 TL	16	1651220000	144,85 TL	56	1680411687	1,12 TL	40	1700000000		
1608990000	15,30 TL	16	1651550000	5,60 TL	55	1686110000	276,70 TL	49	1701230000	78,60 €	86
1609000000	18,15 TL	16	1651560000	5,60 TL	56	1686120000	279,45 TL	49	1701231000	65,50 €	86
1609010000	21,05 TL	16	1651600000	5,60 TL	56	1686130000	279,45 TL	49	1701240000	101,00 €	86
1609020000	24,35 TL	16	1651610000	5,60 TL	56	1686140000	279,45 TL	49	1701241000	85,00 €	86
1609030000	25,40 TL	16	1651970000	8,35 TL	13	1686150000	277,55 TL	49	1701250000	88,50 €	87
1609801044	0,455 TL	37	1651980000	15,30 TL	13	1686160000	84,80 TL	49	1705920000	75,40 €	86
1609820000	0,456 TL	37	1651990000	46,85 TL	13	1686170000	84,80 TL	49	1705921000	55,70 €	86
1609840000	0,456 TL	37	1652000000	69,75 TL	13	1686180000	85,70 TL	49	1705930000	90,60 €	86
1609860000	0,792 TL	37	1652010000	16,25 TL	13	1686190000	85,70 TL	49	1705931000	71,00 €	86
1609900000	0,792 TL	37	1652020000	36,80 TL	13	1686200000	85,70 TL	49	1705940000	106,00 €	86
1609940000	1,69 TL	43	1652030000	69,75 TL	13	1686210000	83,85 TL	49	1705941000	92,00 €	87
1609940000	1,69 TL	89	1652520000	71,70 TL	54	1686360001	98,75 TL	48	1707270000	5,80 TL	42
1609981044	1,03 TL	40	1652520000	71,70 TL	55	1686361044	98,75 TL	48	1711930000	8,55 TL	13
1609981687	1,03 TL	40	1652640000	71,70 TL	54	1686361687	98,75 TL	48	1712460000	279,00 TL	54
1610000000	1,04 TL	38	1652640000	71,70 TL	55	1686380001	98,75 TL	49	1712491044	118,35 TL	49
1610700000	7,85 TL	48	1652750000	106,65 TL	54	1686381044	98,75 TL	49	1712491687	118,35 TL	49
1610840000	3,40 TL	15	1652750000	106,65 TL	55	1686381687	98,75 TL	49	1712510000	376,30 TL	54
1611950000	28,00 TL	57	1653200000	144,00 TL	54	1686400001	98,75 TL	49	1712520000	479,80 TL	54
1611960000	35,00 TL	57	1653200000	144,00 TL	55	1686401044	98,75 TL	49	1712530000	521,00 TL	54
1611980000	30,80 TL	57	1654070000	101,10 TL	54	1686401687	98,75 TL	49	1712540000	990,00 TL	54
1611990000	44,20 TL	57	1654220000	101,10 TL	54	16864210001	98,75 TL	49	1712550000	1.380,00 TL	54
1612010000	46,60 TL	57	1654220000	101,10 TL	56	1686421044	98,75 TL	49	1712560000	176,10 TL	54
1612020000	59,15 TL	57	1654220000	101,10 TL	56	1686421687	98,75 TL	49	1712570000	220,00 TL	54
1612040000	70,35 TL	57	1654370000	160,70 TL	54	1689970000	41,05 TL	12	1712590000	185,85 TL	54
1612050000	70,80 TL	57	1654370000	160,70 TL	56	1693800000	3,65 TL	8	1712600000	167,65 TL	54
1612070000	50,00 TL	57	1654580000	133,20 TL	54	1693800000	3,65 TL	16	1712660000	330,00 TL	54
1612080000	76,00 TL	57	1654580000	133,20 TL	56	1693800000	3,65 TL	29	1712670000	420,00 TL	54
1612130000	69,00 TL	57	1656480000	104,35 TL	54	1693810000	6,35 TL	8	1712680000	476,95 TL	54
1612140000	99,00 TL	58	1656480000	104,35 TL	56	1693810000	6,35 TL	16	1712690000	517,00 TL	54
1612160000	85,00 TL	58	1656480000	104,35 TL	57	1693810000	6,35 TL	29	1713680000	3,25 TL	42
1612170000	105,00 TL	58	1656590000	106,65 TL	54	1693820000	9,05 TL	8	1713700000	3,50 TL	42
1612190000	73,60 TL	58	1656590000	106,65 TL	56	1693820000	9,05 TL	16	1713720000	5,80 TL	42
1612200000	109,40 TL	58	1656590000	106,65 TL	57	1693820000	9,05 TL	29	1713740000	3,70 TL	42
1616400000	34,40 TL	13	1656720000	169,00 TL	55	1693830000	11,25 TL	8	1713760000	5,80 TL	42
1616410000	82,20 TL	13	1656720000	169,00 TL	56	1693830000	11,25 TL	16	1716080000	3,30 TL	52
1616420000	82,20 TL	13	1656720000	169,00 TL	57	1693840000	14,20 TL	8	1716090000	4,95 TL	52
1616430000	82,20 TL	13	1657270000	142,10 TL	55	1693840000	14,20 TL	16	1716630000	4,50 TL	42
1616440000	82,20 TL	13	1657270000	142,10 TL	56	1693850000	16,90 TL	8	1716640000	4,40 TL	42
1627850000	5,80 TL	16	1657270000	142,10 TL	57	1693850000	16,90 TL	16	1717740000	87,50 TL	5
1627860000	10,55 TL	16	1661230000	114,15 TL	55	1693860000	19,70 TL	8	1718411044	1,00 TL	40
1627870000	16,90 TL	16	1661230000	114,15 TL	56	1693860000	19,70 TL	16	1718411687	1,00 TL	40
1631350000	21,00 TL	38	1661370000	114,15 TL	55	1693870000	22,40 TL	8	1718431044	1,12 TL	40
1631910000	7,45 TL	48	1661370000	114,15 TL	56	1693870000	22,40 TL	16	1718431687	1,12 TL	40
1631920000	21,00 TL	38	1661510000	193,70 TL	55	1693880000	25,40 TL	8	1720620000	0,690 TL	37
1631930000	12,50 TL	38	1661510000	193,70 TL	56	1693880000	25,40 TL	16	1720630000	0,154 TL	77
1632050000	5,25 TL	12	1661720000	171,85 TL	55	1693880000	25,40 TL	29	1720640000	0,224 TL	77
1632060000	5,25 TL	12	1661720000	171,85 TL	56	1695711044	118,35 TL	49	1720650000	0,224 TL	77
1632080000	22,35 TL	12	1665200000	110,20 TL	54	1695711687	118,35 TL	49	1720660000	0,154 TL	77
1632090000	3,60 TL	15	1665230000	97,70 TL	54	1695721044	149,20 TL	49	1720670000	1,96 TL	77
1632100000	3,60 TL	15	1665260000	122,20 TL	55	1695721687	149,20 TL	49	1720680000	1,96 TL	77
1633280000	110,00 TL	8	1665630000	150,30 TL	55	1695731044	118,35 TL	49	1720700000	6,35 TL	16
1633290000	91,80 TL	8	1666840000	290,10 TL	55	1695731687	118,35 TL	49	1720910000	6,35 TL	15
1635000000	0,792 TL	37	1666840000	290,10 TL	57	1695741044	149,20 TL	49	1720920000	9,60 TL	29
1636560000	12,00 TL	7	1666870000	283,15 TL	55	1695741687	149,20 TL	49	1720930000	9,60 TL	29
1636570000	16,65 TL	7	1666870000	283,15 TL	57	1697900000	0,128 TL	77	1720950000	18,65 TL	29
1636580000	22,40 TL	7	1666920000	326,00 TL	55	1697910000	0,199 TL	77	1720960000	2,30 TL	29
1640740000	0,792 TL	37	1666920000	326,00 TL	57	1697920000	0,318 TL	77	1720970000	2,30 TL	29
1646630000	1,04 TL	38	1670370000	225,45 TL	38	1697930000	0,389 TL	77	1723540000	0,229 TL	77
1649300000	7,00 TL	13	1670380000	225,45 TL	38	1697940000	0,849 TL	77	1723550000	0,231 TL	77
1649540000	5,75 TL	15	1674300000	13,45 TL	12	1699800000	0,95 €	77	1723560000	0,229 TL	77
1649550000	5,75 TL	15	1674650000	4,95 TL	15	1699810000	1,00 €	77	1723570000	0,231 TL	77
1650360000	8,35 TL	13	1674730000	7,45 TL	15	1699820000	3,25 TL	42	1724150001	98,75 TL	49
1650370000	8,35 TL	13	1674740000	1,62 TL	43	1699840000	3,50 TL	42	1724151044	98,75 TL	48
1651150000	118,75 TL	55	1674760000	2,70 TL	43	1699860000	3,70 TL	42	1724151687	98,75 TL	48
1651160000	118,35 TL	55	1676630000	7,00 TL	13	1699880000	5,80 TL	42	1724750000	21,00 €	87
1651170000	130,40 TL	56	1677140000	0,894 TL	38	1699900000	1,15 €	77	1730900000	36,80 TL	13
1651180000	130,40 TL	56	1677160000	0,894 TL	38	1699910000	1,20 €	77	1733260000	41,05 TL	12
1651190000	134,60 TL	56	1677180000	0,894 TL	38	1699920000	1,55 €	77	1736181044	1,76 TL	43
1651200000	134,60 TL	56	1677220000	0,894 TL	38	1699930000	2,25 €	77			

Ürün Kodu	Birim Fiyat	Sayfa No	Ürün Kodu	Birim Fiyat	Sayfa No	Ürün Kodu	Birim Fiyat	Sayfa No	Ürün Kodu	Birim Fiyat	Sayfa No
1736181696	1,76 TL	43	1758270000	137,85 TL	118	1783790000	36,80 TL	2	1803860000	10,40 €	88
1739620000	111,85 TL	12	1758320001	1,23 TL	38	1783820000	34,90 TL	3	1803870000	10,40 €	88
1739630000	111,85 TL	12	1758320004	1,23 TL	38	1783950000	65,95 TL	3	1803880000	14,35 €	88
1739650000	180,65 TL	12	1759871044	162,70 TL	49	1783980000	65,95 TL	3	1803920000	21,80 €	88
1739680000	10,55 TL	16	1760490000	1,76 TL	52	1784030001	10,90 €	89	1803930001	31,20 €	88
1739690000	11,00 TL	16	1760500000	2,55 TL	52	1784040001	11,40 €	89	1803930001	31,20 €	96
1739690000	11,00 TL	27	1762440000	46,50 €	37	1784050001	11,40 €	89	1803940000	20,80 €	88
1739700000	14,30 TL	16	1762620000	14,30 TL	8	1784060001	12,00 €	89	1805730000	1,25 TL	39
1740191000	86,00 €	87	1762630000	10,25 TL	8	1784120000	28,70 TL	3	1805760000	1,25 TL	39
1745150000	5,75 TL	15	1763180000	64,05 TL	13	1784130000	41,65 TL	3	1805780000	1,35 TL	39
1745230000	16,65 TL	12	1763940000	52,10 TL	4	1784150000	7,00 TL	6	1805810000	1,35 TL	39
1745240000	16,65 TL	12	1763950000	93,20 TL	4	1784160000	7,45 TL	6	1805830000	1,42 TL	39
1745250000	45,85 TL	12	1764060000	0,298 TL	41	1784180000	31,50 TL	2	1805870000	1,42 TL	39
1745400000	76,00 TL	13	1764070000	0,298 TL	41	1784210000	10,00 TL	6	1805870000	1,42 TL	39
1745760000	58,25 TL	54	1764100000	5,75 TL	15	1784570000	199,00 €	87	1806120000	8,25 TL	38
1745770000	77,35 TL	54	1764110000	3,90 TL	15	1784580000	143,00 €	87	1806180000	0,354 TL	41
1745780000	102,45 TL	54	1764140000	0,298 TL	41	1784590000	214,00 €	87	1806190000	0,718 TL	41
1745780000	102,45 TL	55	1764150000	0,401 TL	41	1784600000	139,00 €	87	1806240000	0,354 TL	41
1745790000	124,35 TL	55	1764190000	0,327 TL	41	1784610000	163,00 €	87	1806250000	0,950 TL	41
1745800000	100,10 TL	55	1764200000	0,327 TL	41	1784610000	163,00 €	87	1806300000	0,504 TL	41
1745820000	58,25 TL	54	1764210000	0,327 TL	41	1784620000	122,50 €	87	1806310000	1,04 TL	41
1745830000	77,35 TL	54	1764220000	0,475 TL	41	1784630000	213,00 €	87	1806360000	0,504 TL	41
1745840000	102,45 TL	54	1764230000	0,745 TL	41	1784640000	110,50 €	87	1806370000	1,10 TL	41
1745840000	102,45 TL	55	1764240000	0,745 TL	41	1784670000	154,00 €	87	1807230000	9,90 €	88
1745850000	124,35 TL	55	1764250000	0,745 TL	41	1784680000	139,00 €	87	1807240000	8,80 €	88
1745860000	100,10 TL	55	1764260000	0,745 TL	41	1784690000	157,00 €	87	1807250000	11,00 €	88
1746750000	12,60 TL	12	1764270000	1,42 TL	41	1784700000	142,00 €	87	1807330000	9,90 €	88
1746760000	12,60 TL	12	1764280000	1,42 TL	41	1784740000	24,00 €	88	1807340000	9,50 €	88
1746770000	34,90 TL	12	1764290000	1,42 TL	41	1784750000	24,00 €	88	1807350000	9,90 €	88
1747320001	1,11 TL	38	1764300000	1,42 TL	41	1784780000	19,70 €	88	1807360000	8,80 €	88
1747320004	1,11 TL	38	1768000000	59,25 TL	12	1784790000	19,70 €	88	1807370000	9,90 €	88
1748660000	4,05 TL	15	1768000000	59,25 TL	12	1790410000	7,20 TL	42	1810850000	3,10 TL	52
1748800000	6,20 TL	15	1771800000	45,85 TL	13	1790420000	7,85 TL	42	1810860000	4,70 TL	52
1749151001	70,75 TL	30	1771810000	44,00 TL	13	1790430000	6,95 TL	42	1811180000	2,50 TL	52
1749161001	98,00 TL	30	1771870000	10,05 TL	15	1790650000	256,00 €	37	1811190000	3,60 TL	52
1751751044	4.173,00 TL	44	1771930000	6,00 TL	42	1791100000	11,25 TL	12	1812630000	6,00 TL	42
1751751687	4.173,00 TL	44	1771950000	64,05 TL	13	1791120000	28,20 TL	12	1812630000	6,00 TL	42
1751811044	1.715,00 TL	44	1771960000	40,55 TL	13	1791160000	3,65 TL	15	1812890000	21,80 €	89
1751811687	1.715,00 TL	44	1773220000	3,70 TL	42	1794040000	33,55 TL	109	1813130000	1,11 TL	38
1751831044	1.976,00 TL	44	1773230000	3,70 TL	42	1794040000	33,55 TL	110	1813160000	1,11 TL	38
1751831687	1.976,00 TL	44	1773880000	127,65 TL	49	1794040000	33,55 TL	111	1813190000	1,23 TL	39
1752080000	28,50 €	87	1774470000	1.326,00 TL	61	1794040000	33,55 TL	118	1813210000	1,23 TL	39
1752131001	52,10 TL	30	1774480000	6.633,00 TL	61	1794050000	33,55 TL	109	1813240000	1,25 TL	39
1753231044	2.543,00 TL	44	1775480000	4,80 TL	12	1794050000	33,55 TL	110	1813260000	1,25 TL	39
1753231687	2.543,00 TL	44	1775490000	4,80 TL	12	1794050000	33,55 TL	111	1814660000	8,50 TL	30
1753241044	2.543,00 TL	44	1776030000	3,25 TL	15	1794050000	33,55 TL	118	1814670000	8,50 TL	30
1753241687	2.543,00 TL	44	1776040000	3,25 TL	15	1794070000	137,85 TL	109	1814680000	8,50 TL	30
1753280000	16,65 TL	29	1776120000	3,40 TL	15	1794070000	137,85 TL	110	1814690000	81,75 TL	13
1753290000	38,20 TL	29	1776130000	6,75 TL	15	1794070000	137,85 TL	111	1814700000	110,90 TL	13
1753311001	44,50 TL	30	1776140000	9,05 TL	15	1794070000	137,85 TL	118	1815070000	9,40 TL	13
1753490000	7,45 TL	48	1776150000	11,45 TL	15	1794080000	137,85 TL	109	1815080000	17,40 TL	14
1753500000	2,35 TL	43	1776200000	29,15 TL	15	1794080000	137,85 TL	110	1815090000	13,35 TL	13
1754170000	16,65 TL	29	1779080001	1,23 TL	39	1794080000	137,85 TL	111	1815100000	22,95 TL	14
1754190000	2,30 TL	29	1779080004	1,23 TL	39	1794080000	137,85 TL	118	1815110000	15,80 TL	14
1754200000	7,95 TL	29	1781540001	10,50 €	89	1798460000	41,05 TL	29	1815120000	24,35 TL	14
1754210000	3,65 TL	29	1781550001	10,40 €	89	1798470000	0,428 TL	41	1815130000	13,35 TL	14
1754220000	7,45 TL	29	1782300000	32,55 TL	12	1798480000	0,428 TL	41	1815140000	22,95 TL	14
1754230000	11,00 TL	29	1782340000	5,75 TL	15	1798490000	0,298 TL	41	1815150000	22,95 TL	14
1754290000	31,10 TL	29	1782710000	4,70 TL	42	1798510000	0,298 TL	41	1815160000	34,90 TL	14
1754960000	36,30 TL	3	1782960000	0,75 €	40	1798520000	0,344 TL	41	1815180000	108,95 TL	14
1754970000	39,20 TL	3	1782970000	0,75 €	40	1798530000	0,344 TL	41	1815190000	11,45 TL	14
1755081001	113,75 TL	30	1782980000	0,75 €	40	1798540000	0,251 TL	41	1815200000	20,60 TL	14
1758250000	7,15 TL	8	1782990000	5,80 TL	42	1798560000	0,251 TL	41	1815210000	27,20 TL	14
1758260000	33,95 TL	8	1783000000	5,80 TL	42	1798580000	0,327 TL	41	1815220000	36,30 TL	14
1758260000	33,95 TL	109	1783100000	21,80 €	89	1798600000	0,327 TL	41	1815280000	80,75 TL	14
1758260000	33,95 TL	110	1783420000	21,80 €	89	1798620000	0,234 TL	40	1815280000	80,75 TL	14
1758260000	33,95 TL	111	1783430000	21,80 €	89	1798640000	0,234 TL	40	1815430000	10,65 TL	14
1758260000	33,95 TL	118	1783550000	10,00 TL	6				1815440000	18,65 TL	14
1758270000	137,85 TL	109	1783560000	44,50 TL	3	1800000000			1815450000	27,20 TL	14
1758270000	137,85 TL	110	1783590000	42,50 TL	3	1802760000	0,90 €	89	1815500000	34,90 TL	14
1758270000	137,85 TL	111	1783600000	61,65 TL	3	1802780000	378,55 TL	2	1815510000	35,90 TL	14
						1803850000	14,35 €	88	1815520000	39,20 TL	14
									1815530000	45,35 TL	14

Ürün Kodu	Birim Fiyat	Sayfa No	Ürün Kodu	Birim Fiyat	Sayfa No	Ürün Kodu	Birim Fiyat	Sayfa No	Ürün Kodu	Birim Fiyat	Sayfa No
1934400000	3,70 TL	43	1985480000	6,35 TL	22	2000000000			2005790000	0,662 TL	45
1934420000	3,70 TL	42	1985490000	9,40 TL	22	2001800000	146,70 €	123	2005810000	4,85 TL	46
1934430000	9,30 TL	43	1985500000	12,40 TL	22	2001810000	230,50 €	123	2005820000	0,690 TL	45
1934680000	3,65 TL	27	1985510000	15,85 TL	22	2001820000	315,00 €	123	2005840000	4,85 TL	47
1934690000	3,70 TL	27	1985520000	19,10 TL	22	2003150000	58,75 €	98	2005850000	0,717 TL	45
1934700000	3,80 TL	27	1985540000	22,35 TL	22	2003170000	58,75 €	98	2005860000	4,85 TL	47
1934810000	42,50 TL	3	1985560000	25,45 TL	22	2003180000	71,80 €	98	2005870000	0,783 TL	45
1934820000	52,10 TL	3	1985580000	27,95 TL	22	2003190000	58,75 €	98	2005880000	4,85 TL	47
1934830000	37,15 TL	3	1985600000	53,20 TL	22	2003370000	60,85 €	98	2005890000	0,587 TL	45
1936500000	17,10 TL	30	1985620000	145,85 TL	22	2004810000	76,50 €	98	2005900000	4,85 TL	47
1937380000	157,90 TL	30	1985680000	27,95 TL	22	2004890000	16,60 €	98	2005910000	0,624 TL	45
1938570000	492,00 €	83	1985740000	4,45 TL	23	2005040000	300,00 €	37	2005920000	4,85 TL	46
1938600000	222,00 €	82	1985760000	9,00 TL	23	2005070000	120,00 €	37	2005930000	0,662 TL	45
1938610000	178,75 €	82	1985780000	13,30 TL	23	2005080000	120,00 €	37	2005950000	0,690 TL	45
1938630000	393,00 €	82	1985800000	27,95 TL	22	2005090000	30,00 €	37	2005970000	0,717 TL	45
1938640000	295,00 €	82	1988100000	26,20 TL	23	2005100000	0,867 TL	46	2005990000	0,783 TL	45
1938660000	424,00 €	82	1988130000	20,95 TL	23	2005110000	0,867 TL	46	2006010000	0,540 TL	45
1938680000	285,00 €	82	1988140000	34,55 TL	23	2005120000	0,867 TL	46	2006030000	0,559 TL	45
1938690000	373,45 €	82	1988160000	23,00 TL	23	2005130000	0,867 TL	46	2006050000	0,671 TL	45
1938700000	458,65 €	82	1988170000	23,00 TL	23	2005140000	0,913 TL	46	2006060000	6,95 TL	47
1938710000	458,65 €	82	1988180000	47,10 TL	23	2005150000	0,913 TL	46	2006070000	0,819 TL	45
1938720000	458,65 €	82	1988190000	47,10 TL	23	2005160000	0,913 TL	46	2006080000	5,35 TL	47
1938730000	376,75 €	82	1988200000	62,80 TL	23	2005170000	0,913 TL	46	2006090000	0,540 TL	45
1943580000	7,65 TL	50	1988230000	26,20 TL	23	2005180000	0,876 TL	46	2006100000	5,35 TL	47
1943590000	11,45 TL	50	1988240000	73,25 TL	23	2005190000	1,15 TL	46	2006110000	0,559 TL	45
1943600000	15,30 TL	50	1988250000	62,80 TL	23	2005200000	1,35 TL	46	2006120000	5,35 TL	47
1943610000	19,10 TL	50	1988260000	36,60 TL	23	2005210000	1,15 TL	46	2006130000	0,671 TL	45
1943620000	22,95 TL	50	1988270000	52,40 TL	23	2005230000	1,15 TL	46	2006140000	5,35 TL	47
1943630000	29,15 TL	50	1988280000	26,20 TL	23	2005240000	0,876 TL	46	2006150000	0,819 TL	45
1943640000	30,65 TL	50	1988290000	26,20 TL	23	2005250000	1,15 TL	46	2006160000	5,35 TL	47
1943650000	37,25 TL	50	1988300000	5,25 TL	24	2005260000	1,35 TL	46	2006170000	0,494 TL	45
1943660000	41,05 TL	50	1988320000	5,25 TL	24	2005270000	10,95 TL	47	2006180000	5,35 TL	47
1943670000	45,35 TL	50	1988340000	6,35 TL	24	2005280000	10,95 TL	47	2006190000	0,540 TL	45
1943680000	49,75 TL	50	1989780000	20,95 TL	23	2005290000	10,95 TL	47	2006200000	2,70 TL	46
1944570000	30,70 €	88	1989800000	23,50 TL	19	2005310000	10,95 TL	47	2006210000	0,606 TL	45
1944580000	30,20 €	88	1989830000	24,85 TL	19	2005320000	1,89 TL	46	2006220000	2,70 TL	46
1948000000	7,85 TL	10	1989860000	28,50 TL	19	2005330000	4,30 TL	47	2006230000	0,755 TL	45
1948020000	15,80 TL	10	1989890000	24,85 TL	19	2005340000	2,50 TL	46	2006240000	2,70 TL	46
1948060000	31,10 TL	10	1989900000	10,55 TL	19	2005350000	4,30 TL	47	2006250000	0,494 TL	45
1948110000	46,85 TL	10	1989930000	21,05 TL	19	2005360000	4,00 TL	46	2006260000	2,70 TL	46
1948150000	62,65 TL	10	1989940000	23,75 TL	19	2005370000	4,30 TL	47	2006270000	0,540 TL	45
1950820000	0,50 €	40	1989950000	27,15 TL	19	2005380000	1,89 TL	46	2006280000	3,10 TL	46
1951870000	0,801 TL	37	1989970000	4,05 TL	22	2005390000	4,30 TL	47	2006290000	0,606 TL	45
1952120000	12,95 €	31	1989980000	4,10 TL	22	2005400000	2,50 TL	46	2006300000	3,10 TL	46
1952130000	14,35 €	31	1990070000	275,00 €	81	2005410000	2,10 TL	47	2006310000	0,755 TL	45
1957580000	62,75 €	31	1990140000	6,35 TL	24	2005420000	4,00 TL	46	2006320000	3,10 TL	46
1957590000	127,00 €	31	1990960000	258,45 TL	111	2005430000	2,10 TL	47	2006330000	0,475 TL	45
1957620000	35,85 €	31	1990970000	551,00 TL	111	2005440000	0,587 TL	45	2006340000	3,10 TL	46
1957710000	7,15 TL	6	1991780000	24,75 TL	18	2005450000	0,624 TL	45	2006350000	0,494 TL	45
1961780000	153,20 €	31	1991790000	10,25 TL	18	2005460000	2,10 TL	47	2006360000	3,10 TL	46
1962840000	15,50 €	98	1991810000	30,25 TL	19	2005470000	0,662 TL	45	2006370000	0,559 TL	45
1962850000	19,50 €	98	1991820000	20,00 TL	18	2005480000	2,10 TL	47	2006380000	3,10 TL	46
1963570000	49,50 €	31	1991830000	20,00 TL	18	2005490000	0,690 TL	45	2006390000	0,680 TL	45
1963600000	19,50 €	96	1991850000	47,25 TL	19	2005500000	1,69 TL	47	2006400000	2,00 TL	46
1963830000	20,00 €	96	1991910000	5,80 TL	22	2005510000	0,717 TL	45	2006410000	0,475 TL	45
1963830000	20,00 €	98	1991920000	4,40 TL	21	2005520000	1,69 TL	47	2006420000	2,00 TL	46
1963840000	19,50 €	98	1991940000	5,80 TL	22	2005530000	0,783 TL	45	2006430000	0,494 TL	45
1966020000	61,65 TL	4	1991950000	5,60 TL	22	2005540000	1,69 TL	47	2006440000	2,00 TL	46
1966060000	106,10 TL	4	1991970000	5,60 TL	22	2005550000	0,587 TL	45	2006450000	0,559 TL	45
1966080000	185,90 TL	4	1992110000	10,25 TL	18	2005570000	1,69 TL	47	2006460000	2,00 TL	46
1966090000	113,75 TL	4	1992220000	41,85 TL	23	2005580000	0,624 TL	45	2006470000	0,680 TL	45
1966810000	10.706,00 TL	61	1992230000	39,35 TL	23	2005600000	1,12 TL	47	2006480000	2,00 TL	46
1968130000	2.777,00 TL	44	1992240000	20,50 TL	23	2005610000	0,662 TL	45	2006490000	2,00 TL	46
1981900015	29,40 €	89	1992250000	37,25 TL	23	2005630000	1,12 TL	47	2006500000	2,45 TL	46
1981900030	28,80 €	89	1992260000	21,95 TL	23	2005640000	0,690 TL	45	2006510000	2,45 TL	46
1981900100	31,50 €	89	1993580000	5,25 TL	23	2005660000	1,12 TL	47	2006520000	2,45 TL	46
1981900150	32,65 €	89	1993590000	5,25 TL	23	2005670000	0,717 TL	45	2006530000	2,45 TL	46
1981900300	37,50 €	89	1993600000	6,35 TL	23	2005690000	1,12 TL	47	2006540000	2,45 TL	46
1981900500	44,00 €	89	1994360000	Sorunuz	126	2005700000	0,783 TL	45	2006550000	2,45 TL	46
1981901000	60,00 €	89	1994370000	Sorunuz	126	2005730000	0,587 TL	45	2006570000	344,65 TL	47
1985410000	3,60 TL	22				2005760000	0,624 TL	45	2006580000	344,65 TL	47

Ürün Sıralı Listesi

Ürün Kodu	Birim Fiyat	Sayfa No	Ürün Kodu	Birim Fiyat	Sayfa No	Ürün Kodu	Birim Fiyat	Sayfa No	Ürün Kodu	Birim Fiyat	Sayfa No
2006590000	428,50 TL	47	2082000000	50,00 €	124	2429020000	6,80 TL	24	2482260000	8,15 TL	20
2006600000	428,50 TL	47	2082010000	55,00 €	124	2429040000	8,10 TL	24	2482270000	8,15 TL	20
2006610000	428,50 TL	47	2082040000	35,00 €	124	2429850000	34,40 TL	19	2482280000	8,15 TL	20
2006620000	774,00 TL	47	2082050000	35,00 €	124	2429860000	43,20 TL	19	2482290000	8,15 TL	20
2006630000	774,00 TL	47	2082060000	36,00 €	124	2429870000	103,60 TL	19	2482300000	8,15 TL	20
2006640000	774,00 TL	47	2082310000	38,00 €	124	2429880000	34,40 TL	19	2482310000	8,15 TL	20
2006650000	1.088,00 TL	47	2082320000	40,00 €	124	2429890000	34,40 TL	19	2482320000	8,15 TL	20
2006660000	1.088,00 TL	47	2082430000	40,00 €	124	2430920000	2.000,00 €	37	2482330000	8,15 TL	20
2006670000	1.088,00 TL	47	2082440000	55,00 €	124	2433820000	6,75 TL	22	2482340000	8,15 TL	20
2006680000	1.710,00 TL	47	2082470000	60,00 €	124	2433950000	880,00 €	132	2482350000	13,75 TL	20
2006690000	1.710,00 TL	47	2082530000	9,00 €	124	2434340000	61,50 TL	19	2482360000	19,30 TL	20
2006700000	1.710,00 TL	47	2082540000	33,00 €	124	2434350000	103,60 TL	19	2482370000	24,85 TL	20
2006710000	2.851,00 TL	47	2082770000	34,00 €	124	2434370000	67,90 TL	19	2482380000	30,40 TL	20
2006720000	2.851,00 TL	47	2083360000	34,00 €	124	2434380000	103,60 TL	19	2482390000	36,00 TL	20
2006730000	2.851,00 TL	47				2434390000	103,60 TL	19	2482400000	41,60 TL	20
2007100000	0,251 TL	44				2435400000	300,00 €	92	2482410000	47,05 TL	20
2007110000	0,261 TL	44	2100000000			2436210000	175,00 €	34	2482420000	52,65 TL	21
2007120000	0,261 TL	44	2122910000	2,25 €	124	2436340000	299,70 €	34	2482430000	58,20 TL	21
2007130000	0,261 TL	44	2122920000	2,25 €	124	2436350000	255,30 €	34	2482440000	33,50 TL	20
2007140000	0,306 TL	44	2122930000	2,25 €	124	2438520000	4.050,00 €	37	2482450000	27,90 TL	20
2007150000	0,311 TL	44	2123000000	1,25 €	125	2441000000	0,170 TL	71	2482460000	22,00 TL	20
2007160000	0,327 TL	44	2123050000	4,50 €	124	2448100000	315,00 €	114	2482510000	4,05 TL	20
2007170000	0,344 TL	44				2458990000	94,25 TL	23	2482520000	4,05 TL	20
2007180000	0,327 TL	44	2300000000			2459010000	109,00 TL	24	2483990000	126,00 TL	31
2007190000	0,339 TL	44	2330260000	1,20 €	89	2460120000	109,00 TL	24	2485840000	12,80 TL	20
2007200000	0,344 TL	44				2460130000	109,00 TL	24	2485850000	12,80 TL	20
2007210000	0,373 TL	44	2400000000			2460140000	109,00 TL	24	2485860000	29,45 TL	20
2007420000	240,00 €	81	2425410000	325,00 €	120	2460180000	94,25 TL	24	2485870000	45,50 TL	20
2007430000	225,00 €	81	2425420000	420,00 €	120	2460190000	94,25 TL	24	2485920000	28,75 TL	20
2008130000	840,00 €	132	2425430000	615,00 €	120	2460200000	94,25 TL	24	2485930000	28,75 TL	20
2009360000	42,50 €	80	2425450000	850,00 €	120	2460450000	3,65 TL	125	2485980000	3,65 TL	20
2009980000	1,02 TL	46	2425460000	1.310,00 €	120	2460730000	166,05 TL	125	2486090000	130,00 €	123
2010620000	1,02 TL	46	2425470000	525,00 €	120	2460740000	29,10 TL	125	2486100000	150,00 €	123
2035590000	4,20 TL	21	2425480000	540,00 €	120	2460750000	25,40 TL	125	2486110000	200,00 €	123
2044840000	270,00 €	115	2425490000	1.070,00 €	120	2460760000	22,35 TL	125	2486640000	6,15 TL	22
2044850000	210,00 €	114	2425500000	2.500,00 €	120	2460770000	19,15 TL	125	2486660000	4,95 TL	22
2051180000	7,45 TL	18	2425510000	1.600,00 €	120	2460780000	16,15 TL	125	2488560000	75,35 TL	54
2051210000	7,45 TL	18	2425520000	860,00 €	120	2460790000	12,95 TL	125	2488560000	75,35 TL	55
2051240000	14,90 TL	18	2426250000	527,00 €	82	2460800000	9,85 TL	125	2488580000	110,85 TL	54
2051280000	14,90 TL	18	2426260000	527,00 €	82	2460810000	6,60 TL	125	2488580000	110,85 TL	56
2051360000	20,80 TL	19	2426270000	508,00 €	82	2466530000	27,70 TL	19	2488590000	115,35 TL	55
2051410000	39,20 TL	19	2426280000	548,00 €	82	2466610000	64,05 TL	19	2488590000	115,35 TL	56
2051500000	14,25 TL	18	2426290000	535,00 €	82	2466650000	150,00 €	122	2488590000	115,35 TL	57
2051520000	14,25 TL	18	2426300000	500,00 €	82	2466670000	170,00 €	122	2488600000	123,10 TL	55
2051560000	39,20 TL	19	2426310000	540,00 €	82	2466680000	270,00 €	122	2488600000	123,10 TL	56
2051680000	4,10 TL	21	2426320000	527,00 €	82	2466690000	380,00 €	122	2490360000	19,45 TL	18
2051690000	4,10 TL	21	2426330000	423,65 €	83	2466900000	600,00 €	122	2490370000	19,45 TL	18
2051720000	5,95 TL	21	2426340000	553,00 €	83	2466910000	225,00 €	122	2490380000	6,60 TL	22
2051880000	5,95 TL	21	2426360000	368,50 €	83	2466920000	645,00 €	122	2490390000	6,60 TL	22
2051900000	5,25 TL	21	2426370000	471,50 €	83	2467030000	440,00 €	122	2490440000	42,45 TL	19
2051910000	5,25 TL	21	2426380000	535,00 €	83	2467320000	65,00 €	123	2490510000	30,65 TL	18
2065120000	24,75 TL	18	2426390000	500,00 €	83	2469360000	170,10 TL	133	2490520000	30,65 TL	18
2067070000	18,05 €	98	2426400000	540,00 €	83	2469370000	12,80 TL	18	2490530000	6,95 TL	22
2067080000	33,65 €	98	2428510000	35,25 TL	19	2469390000	29,45 TL	18	2490540000	6,95 TL	22
2080360000	40,00 €	124	2428520000	35,25 TL	19	2469400000	28,75 TL	18	2490590000	61,90 TL	19
2080410000	45,00 €	124	2428530000	57,90 TL	19	2469410000	45,35 TL	18	2491270000	35,00 €	124
2080420000	31,00 €	124	2428540000	57,90 TL	19	2471430000	12,80 TL	18	2491280000	35,00 €	124
2080480000	31,00 €	124	2428550000	73,25 TL	19	2471440000	12,80 TL	18	2491290000	36,00 €	124
2080490000	32,00 €	124	2428560000	6,75 TL	22	2471450000	28,75 TL	18	2495040000	3,00 €	124
2080500000	32,00 €	124	2428840000	57,90 TL	19	2471460000	28,75 TL	18	2495070000	3,00 €	124
2080600000	34,00 €	124	2428860000	6,75 TL	22	2476450000	420,00 €	80	2495080000	3,50 €	124
2080650000	34,00 €	124	2428910000	60,75 TL	23	2482160000	6,60 TL	19	2495090000	3,00 €	124
2080750000	105,00 €	124	2428920000	81,15 TL	23	2482170000	6,60 TL	19	2495100000	6,00 €	124
2080880000	105,00 €	124	2428930000	18,25 TL	23	2482180000	8,15 TL	19	2495380000	2,50 €	125
2080920000	115,00 €	124	2428940000	60,75 TL	23	2482190000	8,15 TL	20	2496190000	42,00 €	110
2081650000	105,00 €	124	2428950000	53,75 TL	23	2482200000	9,20 TL	20			
2081820000	115,00 €	124	2428960000	18,25 TL	23	2482210000	9,20 TL	20	2500000000		
2081870000	6,75 €	124	2428980000	43,20 TL	23	2482220000	23,15 TL	19	2500860000	585,00 €	120
2081880000	29,00 €	124	2428990000	81,15 TL	24	2482230000	28,80 TL	20	2500870000	925,00 €	120
2081890000	31,00 €	124	2429000000	94,70 TL	24	2482240000	30,85 TL	20	2500880000	585,00 €	120
2081900000	29,00 €	124	2429010000	71,75 TL	24	2482250000	8,15 TL	20	2500890000	925,00 €	120

Ürün Kodu	Birim Fiyat	Sayfa No
2500980000	95,00 €	112
2501110000	125,00 €	118
2502530000	63,60 TL	31
2502540000	63,60 TL	31
2502550000	63,60 TL	31
2502560000	63,60 TL	31
2502570000	63,60 TL	31
2502580000	117,50 TL	31
2502590000	117,50 TL	31
2502600000	117,50 TL	31
2502610000	117,50 TL	31
2502620000	182,25 TL	31
2502640000	182,25 TL	31
2502650000	182,25 TL	31
2502660000	120,70 TL	31
2502670000	120,70 TL	31
2502680000	120,70 TL	31
2502690000	120,70 TL	31
2502700000	236,20 TL	31
2502710000	236,20 TL	31
2502720000	236,20 TL	31
2502730000	236,20 TL	31
2502740000	236,20 TL	31
2502750000	247,00 TL	31
2502760000	247,00 TL	31
2502770000	247,00 TL	31
2502780000	247,00 TL	31
2502790000	247,00 TL	31
2502800000	484,40 TL	31
2502810000	484,40 TL	32
2502820000	484,40 TL	32
2502830000	484,40 TL	32
2502840000	484,40 TL	32
2502850000	603,00 TL	32
2502860000	603,00 TL	32
2502870000	603,00 TL	32
2502880000	603,00 TL	32
2502890000	603,00 TL	32
2502900000	1.196,00 TL	32
2502910000	1.196,00 TL	32
2502920000	1.196,00 TL	32
2502930000	1.196,00 TL	32
2502940000	1.196,00 TL	32
2502950000	117,50 TL	31
2503090000	120,70 TL	31
2503650000	22,00 TL	23
2503880000	27,55 TL	23
2503900000	49,55 TL	23
2503910000	24,25 TL	23
2517450000	125,00 €	118
2518250000	220,20 TL	32
2518330000	408,80 TL	32
2518340000	784,00 TL	32
2518540000	364,85 TL	32
2518570000	441,20 TL	32
2519470000	718,00 TL	32
2519480000	714,00 TL	32
2519490000	730,00 TL	32
2521730000	552,00 TL	32
2522720000	22,00 TL	23
2522840000	27,55 TL	23
2522860000	49,55 TL	23
2522870000	24,25 TL	23
2524850000	128,30 TL	31
2526810000	29,95 €	34
2527880000	173,15 €	34
2527890000	179,80 €	34
2527900000	190,90 €	34
2527910000	221,80 €	34
2527920000	197,35 €	34
2527930000	208,70 €	34

Ürün Kodu	Birim Fiyat	Sayfa No
2527940000	218,65 €	34
2527950000	248,65 €	34
2530180000	72,00 €	133
2530550000	64,80 €	133
2530580000	147,30 €	133
2530590000	158,40 €	133
2530610000	135,90 €	133
2530620000	146,10 €	133
2530640000	88,20 €	133
2530650000	97,20 €	133
2534130000	3.880,00 €	120
2534160000	3.880,00 €	120
2535770000	131,00 €	34
2535810000	221,80 €	34
2535830000	286,40 €	34
2535850000	353,00 €	34
2535870000	419,60 €	34
2535890000	509,00 €	34
2535910000	553,00 €	34
2535930000	1.670,00 €	94
2535940000	1.550,00 €	94
2535960000	1.885,00 €	94
2536600000	720,00 €	95
2536650000	775,00 €	95
2536680000	865,00 €	95
2536690000	990,00 €	95
2548140000	36,40 TL	19
2555800000	900,00 €	83
2555810000	1.125,00 €	83
2555820000	1.575,00 €	83
2555830000	1.800,00 €	83
2555840000	2.250,00 €	83
2555850000	2.535,00 €	83
2578530000	25,00 €	123
2578550000	27,00 €	123
2578560000	29,00 €	123
2588460000	25,85 TL	75
2588580000	32,85 TL	75
2588630000	69,95 TL	75
2588720000	85,60 TL	75
2588770000	91,55 TL	75
2588790000	99,90 TL	75
2588850000	138,75 TL	75
2589110000	17,45 TL	75
2589130000	20,10 TL	75
2589150000	29,00 TL	75
2589180000	42,05 TL	75
2589210000	26,55 TL	75
2589230000	35,00 TL	75
2589240000	47,80 TL	75
2589260000	60,00 TL	75
2589280000	33,70 TL	75
2589300000	42,00 TL	75
2589310000	52,60 TL	75
2589330000	80,00 TL	75
2589370000	51,00 TL	75
2589380000	66,00 TL	75
2589400000	86,90 TL	75
2589420000	64,00 TL	75
2589440000	79,80 TL	75
2589450000	144,90 TL	75
2589470000	95,60 TL	75
2589490000	103,00 TL	75
2589990000	68,00 TL	75
2590000000	55,00 TL	75
2590020000	48,00 TL	75
2590050000	41,00 TL	75
2590080000	21,00 TL	75
2590110000	12,00 TL	75

Ürün Kodu	Birim Fiyat	Sayfa No
2800000000		
2826000000	0,072 TL	71
2828000000	0,120 TL	71
2829000000	0,250 TL	71
2900000000		
2916600000	649,00 TL	58
3100000000		
3170000000	1,12 TL	71
3171000000	1,42 TL	71
3172000000	1,49 TL	71
3173000000	1,89 TL	71
3400000000		
3420000000	15,70 €	68
3421000000	24,85 €	68
3422000000	20,95 €	68
3423000000	27,50 €	68
3424000000	54,95 €	68
3425000000	61,50 €	68
3426000000	91,60 €	68
4000000000		
4058570000	19,90 TL	100
4058600000	25,60 TL	100
4058610000	40,95 TL	100
4058630000	39,60 TL	100
4100000000		
4144870000	224,65 TL	52
4157440000	178,75 TL	52
4300000000		
4323210000	2,85 €	31
4323220000	2,85 €	31
4323230000	2,85 €	31
4323240000	2,85 €	31
4329610000	2,85 €	31
4400000000		
4442000000	2,35 TL	71
4600000000		
4629000000	0,097 TL	71
4630000000	0,097 TL	71
4631000000	0,097 TL	71
4900000000		
4925000000	0,370 TL	71
5300000000		
5335000000	0,308 TL	71
5342000000	0,410 TL	71
5400000000		
5425000000	0,084 TL	71
5600000000		
5656000000	0,236 TL	71
5657000000	0,428 TL	71
5658000000	0,559 TL	71
5659000000	0,521 TL	71
5660000000	0,717 TL	71

Ürün Kodu	Birim Fiyat	Sayfa No
5700000000		
5732000000	8,50 €	68
5733000000	20,95 €	68
5734000000	15,70 €	68
5735000000	24,85 €	68
5736000000	75,90 €	68
5737000000	107,30 €	68
6300000000		
6351000000	0,167 TL	71
6400000000		
6449600000	192,40 TL	58
6900000000		
6907000000	0,097 TL	71
7500000000		
7512000479	1.000,00 €	132
7512000498	Sorunuz	132
7512000541	Sorunuz	132
7512000542	Sorunuz	132
7512000543	Sorunuz	132
7700000000		
7730000011	20,50 TL	33
7730000012	42,00 TL	33
7730000013	23,75 TL	33
7730000014	48,45 TL	33
7730000015	6,10 TL	75
7730000016	6,80 TL	75
7730000017	7,95 TL	75
7730000018	8,35 TL	75
7730000019	10,05 TL	75
7730000020	11,20 TL	75
7730000021	17,75 TL	75
7730000022	19,50 TL	75
7730000023	22,35 TL	75
7730000025	39,15 TL	75
7730000026	6,95 TL	76
7730000027	6,95 TL	76
7730000028	8,10 TL	76
7730000029	8,35 TL	76
7730000031	9,80 TL	76
7730000032	10,25 TL	76
7730000033	14,05 TL	76
7730000035	17,75 TL	76
7730000037	34,90 TL	76
7730000409	12,10 TL	75
7730000458	47,65 TL	33
7730000459	5,80 TL	75
7730000460	27,05 TL	75
7730000461	42,85 TL	75
7730000481	23,75 TL	76
7730000489	14,05 TL	76
7730000490	52,20 TL	33
7760052061	2,85 €	126
7760052061	2,85 €	126
7760054115	215,00 €	114
7760054117	268,50 €	114
7760054119	157,85 €	114
7760054120	157,85 €	114
7760054121	157,85 €	114
7760054122	185,95 €	114
7760054123	138,25 €	114
7760054124	210,00 €	114
7760054164	195,00 €	115
7760054165	215,00 €	115
7760054175	115,00 €	116

Ürün Sıralı Listesi

Ürün Kodu	Birim Fiyat	Sayfa No
7760054176	125,00 €	116
7760054177	125,00 €	116
7760054178	110,00 €	116
7760054179	75,00 €	116
7760054180	90,00 €	116
7760054181	80,00 €	116
7760054182	85,00 €	116
7760054244	140,00 €	117
7760054245	160,00 €	117
7760054246	100,00 €	116
7760054247	120,00 €	116
7760054248	75,00 €	117
7760054299	115,00 €	117
7760054300	100,00 €	116
7760054305	200,00 €	115
7760054306	245,00 €	115
7760054307	110,00 €	116
7760054308	125,00 €	116
7760056014	17,00 TL	104
7760056014	17,00 TL	106
7760056015	11,20 TL	105
7760056016	11,20 TL	105
7760056017	11,20 TL	105
7760056018	11,20 TL	105
7760056045	17,00 TL	104
7760056050	28,80 TL	104
7760056051	28,80 TL	104
7760056052	30,05 TL	104
7760056053	31,65 TL	104
7760056054	40,95 TL	104
7760056055	30,05 TL	104
7760056056	30,05 TL	104
7760056057	30,05 TL	104
7760056058	31,65 TL	104
7760056059	30,80 TL	104
7760056060	30,80 TL	104
7760056061	32,15 TL	104
7760056062	34,00 TL	104
7760056063	43,35 TL	104
7760056064	32,80 TL	104
7760056065	32,80 TL	104
7760056066	32,80 TL	104
7760056067	34,00 TL	104
7760056078	30,80 TL	104
7760056079	30,80 TL	104
7760056080	31,65 TL	104
7760056081	33,55 TL	104
7760056082	43,35 TL	104
7760056083	31,65 TL	104
7760056084	31,65 TL	104
7760056085	31,65 TL	104
7760056086	33,55 TL	104
7760056087	32,80 TL	104
7760056088	32,80 TL	104
7760056089	34,00 TL	104
7760056090	35,90 TL	104
7760056091	45,25 TL	104
7760056092	34,40 TL	104
7760056093	34,40 TL	104
7760056094	34,40 TL	104
7760056095	39,00 TL	104
7760056106	17,00 TL	104
7760056107	21,45 TL	104
7760056108	0,894 TL	104
7760056108	0,894 TL	105
7760056109	5,60 TL	104
7760056169	5,60 TL	106
7760056225	57,80 TL	105
7760056226	69,40 TL	105
7760056227	80,60 TL	105
7760056234	5,60 TL	105

Ürün Kodu	Birim Fiyat	Sayfa No
7760056235	5,60 TL	105
7760056296	24,70 TL	102
7760056297	24,70 TL	102
7760056298	27,05 TL	102
7760056299	30,30 TL	102
7760056300	32,65 TL	102
7760056301	32,65 TL	102
7760056302	32,65 TL	102
7760056303	28,80 TL	102
7760056304	28,80 TL	102
7760056305	31,20 TL	102
7760056306	34,00 TL	102
7760056307	36,40 TL	102
7760056308	36,40 TL	102
7760056309	36,40 TL	102
7760056310	28,80 TL	102
7760056311	28,80 TL	102
7760056312	31,20 TL	102
7760056313	34,00 TL	102
7760056314	32,65 TL	103
7760056315	32,65 TL	103
7760056316	34,90 TL	103
7760056317	38,15 TL	103
7760056318	40,50 TL	103
7760056319	40,50 TL	103
7760056320	40,50 TL	103
7760056321	27,05 TL	103
7760056322	27,05 TL	103
7760056323	28,80 TL	103
7760056324	31,65 TL	103
7760056325	34,00 TL	103
7760056326	34,00 TL	103
7760056327	34,00 TL	103
7760056328	32,65 TL	103
7760056329	32,65 TL	103
7760056330	34,90 TL	103
7760056331	38,15 TL	103
7760056332	40,50 TL	103
7760056333	40,50 TL	103
7760056334	40,50 TL	103
7760056335	32,65 TL	103
7760056336	32,65 TL	103
7760056337	34,90 TL	103
7760056338	38,15 TL	103
7760056339	36,40 TL	103
7760056340	36,40 TL	103
7760056341	38,60 TL	103
7760056342	42,00 TL	103
7760056343	44,20 TL	103
7760056344	44,20 TL	103
7760056345	44,20 TL	103
7760056350	20,00 TL	103
7760056351	21,45 TL	103
7760056352	2,35 TL	103
7760056362	57,75 TL	104
7760056363	62,50 TL	104
7760056364	35,00 TL	103
7760056365	36,00 TL	103
7791400746	340,00 €	132
7791400879	350,00 €	132
7900000000		
7904100000	5,55 TL	15
7904180000	12,00 TL	12
7904210000	5,55 TL	15
7904290000	14,50 TL	12
7910180000	37,75 TL	3
7910210000	42,05 TL	3
7910240000	59,80 TL	4
7914370000	104,15 TL	4
7914380000	104,15 TL	4

Ürün Kodu	Birim Fiyat	Sayfa No
7914390000	104,15 TL	4
7914400000	104,15 TL	4
7917000000	12,00 TL	6
7917030000	57,85 TL	3
7920340000	4,10 TL	29
7921560000	23,90 TL	9
7921560000	23,90 TL	13
7921560000	23,90 TL	26
7921570000	52,10 TL	9
7921570000	52,10 TL	13
7921570000	52,10 TL	26
7921600000	56,35 TL	9
7921600000	56,35 TL	13
7921600000	56,35 TL	26
7940006040	0,960 TL	77
7940006047	0,960 TL	77
7940006050	0,109 TL	77
7940006051	0,109 TL	77
7940006056	0,549 TL	77
7940006057	0,549 TL	77
7940006064	0,465 TL	77
7940006065	0,465 TL	77
7940006068	0,645 TL	77
7940006069	0,645 TL	77
7940006070	1,19 TL	77
7940006071	1,19 TL	77
7940006072	1,35 TL	77
7940006073	1,35 TL	77
7940006074	4,00 TL	77
7940006075	4,00 TL	77
7940006690	0,045 TL	77
7940007051	0,045 TL	77
7940018455	11,20 TL	105
7940018457	11,20 TL	105
7940045760	386,50 €	114
8200000000		
8227350000	91,00 €	118
8237710000	291,55 TL	109
8260280000	91,00 €	118
8300000000		
8365980000	127,15 TL	109
8389030000	13,05 TL	109
8390590000	222,20 TL	109
8400000000		
8411190000	143,55 €	118
8420880000	277,55 TL	109
8425720000	115,70 €	118
8432090000	168,00 €	117
8432150000	168,00 €	117
8432180000	155,00 €	117
8432210000	155,00 €	117
8432240000	185,00 €	117
8432270000	185,00 €	117
8444950000	173,00 €	117
8445010000	132,80 €	117
8445040000	132,80 €	117
8447130000	132,80 €	117
8448920000	245,45 TL	130
8448940000	242,65 TL	130
8448960000	237,05 TL	130
8448970000	237,60 TL	130
8449000000	261,30 TL	130
8449030000	268,25 TL	130
8449040000	317,60 TL	130
8449050000	277,10 TL	130
8449140000	145,80 TL	130
8449150000	148,10 TL	130

Ürün Kodu	Birim Fiyat	Sayfa No
8449160000	142,10 TL	130
8463580000	265,50 €	117
8472880000	205,40 TL	130
8473000000	115,70 €	118
8473010000	115,70 €	118
8473020000	115,70 €	118
8483680000	115,70 €	118
8500000000		
8528650000	129,50 €	117
8543720000	216,50 €	117
8543820000	218,00 €	117
8560700000	212,00 €	117
8560720000	222,00 €	117
8581160000	247,50 €	117
8581180000	270,00 €	117
8581200000	267,80 €	117
8581220000	329,00 €	118
8600000000		
8604420000	115,70 €	118
8604430000	115,70 €	118
8615690000	315,00 €	117
8615700000	315,00 €	117
8630740000	5,20 TL	5
8630740000	5,20 TL	14
8630740000	5,20 TL	21
8647680000	55,70 €	110
8647700000	64,50 €	110
8647720000	43,00 €	110
8647740000	70,00 €	110
8659840000	14,00 €	110
8689760000	47,50 TL	101
8689770000	77,35 TL	101
8689800000	75,85 TL	101
8689810000	68,05 TL	101
8689820000	49,80 TL	101
8689830000	85,20 TL	101
8689860000	44,70 TL	101
8689950000	82,90 TL	101
8689980000	79,65 TL	101
8689990000	97,35 TL	101
8690000000	50,30 TL	101
8690010000	139,00 TL	101
8690030000	47,50 TL	101
8690040000	47,50 TL	101
8690110000	53,00 TL	101
8690120000	71,30 TL	101
8690150000	95,50 TL	101
8690160000	61,50 TL	101
8690200000	47,50 TL	101
8690830000	30,05 TL	100
8690880000	31,65 TL	101
8690890000	30,80 TL	101
8690900000	35,25 TL	101
8690950000	18,15 TL	100
8690950000	18,15 TL	101
8691010000	21,45 TL	100
8691010000	21,45 TL	101
8691030000	21,45 TL	100
8691030000	21,45 TL	101
8691040000	28,40 TL	101
8691060000	30,80 TL	100
8691060000	30,80 TL	101
8691090000	3,15 TL	100
8691110000	3,40 TL	101
8693260000	19,10 TL	100
8693320000	44,00 TL	100
8693500000	22,20 TL	100
8693890000	33,55 TL	100

Ürün Kodu	Birim Fiyat	Sayfa No
8700000000		
8704240000	319,05 TL	130
8705630000	318,00 €	118
8705640000	236,70 €	118
8710620000	72,80 €	122
8731720000	25,85 TL	13
8734580000	10,80 €	33
8739140000	65,00 €	123
8754960000	66,50 €	123
8754970000	65,00 €	123

Ürün Kodu	Birim Fiyat	Sayfa No
8800000000		
8808420000	2.893,00 TL	96
8823280000	264,55 TL	130
8869430000	75,00 TL	101
8869440000	3,25 TL	101
8869490000	27,45 TL	100
8869500000	41,45 TL	100
8869510000	2,85 TL	100
8869590000	23,75 TL	100
8869590000	23,75 TL	101
8869630000	37,00 TL	100
8869630000	37,00 TL	101
8869650000	39,00 TL	100
8869650000	39,00 TL	101
8869810000	28,80 TL	100
8869840000	26,05 TL	100
8869850000	35,90 TL	100
8869860000	39,60 TL	100
8869890000	24,25 TL	100
8869920000	27,45 TL	100
8869930000	53,00 TL	100
8869940000	54,00 TL	100
8870100000	39,00 TL	100
8870130000	39,15 TL	100
8870140000	47,05 TL	100
8870150000	84,00 TL	100
8870180000	36,40 TL	100
8870210000	36,40 TL	100
8870220000	69,00 TL	100
8870370000	65,00 TL	100
8870840000	12,00 TL	100
8870850000	5,60 TL	101
8871000000	91,80 TL	102
8871010000	90,80 TL	102
8871020000	139,00 TL	102
8871030000	94,50 TL	102
8871040000	124,00 TL	102
8871050000	117,85 TL	102
8876220000	69,00 TL	101
8879230000	66,50 €	123
8897090000	98,75 TL	102
8897100000	100,60 TL	102

Ürün Kodu	Birim Fiyat	Sayfa No
8900000000		
8920940000	151,80 TL	102
8920950000	151,80 TL	102
8920960000	167,20 TL	102
8920970000	159,30 TL	102
8920980000	199,00 TL	102
8920990000	158,85 TL	102
8921010000	115,50 TL	102
8921020000	168,15 TL	102
8921030000	160,70 TL	102
8921040000	160,70 TL	102
8921050000	152,75 TL	102
8921060000	158,35 TL	102
8924200000	193,00 €	129
8924210000	99,60 €	129
8924220000	193,00 €	129

Ürün Kodu	Birim Fiyat	Sayfa No
8924230000	99,60 €	129
8924260000	64,50 €	130
8924270000	58,90 €	129
8924280000	37,50 €	130
8924290000	37,50 €	129
8924320000	193,00 €	129
8924330000	99,60 €	129
8924340000	193,00 €	129
8924350000	99,60 €	129
8924360000	193,00 €	129
8924370000	99,60 €	129
8924380000	193,00 €	129
8924400000	171,50 €	129
8924420000	91,00 €	129
8924440000	171,50 €	129
8924450000	91,00 €	129
8924470000	171,50 €	129
8924480000	91,00 €	129
8924490000	171,50 €	129
8924500000	91,00 €	129
8924520000	91,00 €	129
8924530000	91,00 €	129
8924700000	58,90 €	130
8924710000	54,50 €	129
8924720000	32,00 €	130
8924730000	32,00 €	129
8937830000	375,45 TL	111
8937920000	247,30 TL	112
8937930000	247,30 TL	112
8937940000	377,75 TL	111
8937970000	402,90 TL	111
8937980000	247,30 TL	111
8937990000	295,00 TL	111
8939670000	374,00 €	117
8939680000	374,00 €	117
8946920000	29,00 €	96
8946960000	22,00 €	96
8947000000	33,50 €	96
8947820000	91,00 €	128
8947830000	91,00 €	128
8947840000	91,00 €	128
8947850000	75,00 €	128
8948600000	213,75 TL	130
8948610000	211,00 TL	130
8948620000	211,00 TL	130
8950760000	96,40 TL	110
8950780000	96,40 TL	110
8950860000	102,45 TL	110
8950880000	112,25 TL	110
8950890000	120,15 TL	110
8950960000	120,60 TL	110
8950980000	120,60 TL	110
8951060000	127,15 TL	110
8951080000	136,00 TL	110
8951090000	143,90 TL	110
8951160000	189,05 TL	110
8951180000	189,05 TL	110
8951260000	195,15 TL	110
8951280000	204,05 TL	110
8951290000	212,35 TL	110
8951460000	192,80 €	129
8951470000	192,80 €	129
8951480000	192,80 €	129
8951490000	171,50 €	129
8951530000	139,50 €	129
8951540000	139,50 €	129
8951550000	139,50 €	129
8951560000	139,50 €	129
8951570000	230,30 €	129
8951580000	230,30 €	129
8951590000	230,30 €	129

Ürün Kodu	Birim Fiyat	Sayfa No
8951600000	230,30 €	129
8951610000	139,50 €	129
8951620000	139,50 €	129
8951630000	139,50 €	129
8951640000	139,50 €	129
8951710000	64,25 €	129
8951720000	72,90 €	129
8951730000	42,90 €	129
8951740000	42,90 €	129
8951750000	69,50 €	130
8951760000	69,50 €	130
8951770000	42,80 €	129
8951780000	42,80 €	129
8951810000	53,50 €	130
8951820000	85,70 €	130
8951830000	53,50 €	130
8951840000	85,70 €	130
8951850000	1.480,00 €	130
8953590000	128,50 €	130
8953600000	128,50 €	130
8953620000	128,50 €	130
8953640000	128,50 €	130
8953660000	128,50 €	130
8953670000	128,50 €	130
8953720000	193,00 €	130
8957030000	58,25 TL	101
8957100000	61,50 TL	101
8957170000	61,50 TL	101
8965340000	153,00 €	115
8965350000	170,80 €	115
8965360000	164,00 €	115
8965370000	203,50 €	115
8965380000	226,00 €	115
8965390000	224,00 €	115
8965400000	187,50 €	115
8965410000	209,00 €	115
8965420000	278,50 €	115
8965430000	240,00 €	115
8965440000	328,00 €	115
8965450000	234,50 €	115
8965460000	327,80 €	115
8965470000	302,00 €	115
8965480000	492,00 €	115
8965490000	327,00 €	115
8965500000	208,80 €	115
8978580000	90,00 €	116
8978580000	90,00 €	117

Ürün Kodu	Birim Fiyat	Sayfa No
9000000000		
9001080000	721,00 TL	60
9001540000	721,00 TL	60
9002170000	429,65 TL	60
9002180000	5.068,00 TL	60
9002190000	7.017,00 TL	60
9002650000	492,75 TL	60
9002660000	535,00 TL	60
9004270000	0,158 TL	72
9004290000	0,158 TL	72
9004320000	0,158 TL	72
9004340000	0,158 TL	72
9004360000	0,215 TL	72
9004500000	750,00 TL	60
9004510000	743,00 TL	8
9004510000	743,00 TL	60
9005000000	770,00 TL	60
9005610000	1.951,00 TL	60
9005700000	1.088,00 TL	60
9005810000	0,217 TL	72
9005820000	0,217 TL	72
9005830000	0,217 TL	72
9005840000	0,217 TL	72

Ürün Kodu	Birim Fiyat	Sayfa No
9005850000	0,242 TL	72
9005860000	0,217 TL	72
9005870000	0,217 TL	72
9005880000	0,217 TL	72
9005890000	0,217 TL	72
9005900000	0,217 TL	72
9005910000	0,242 TL	72
9005990000	1.833,00 TL	60
9006020000	234,90 TL	62
9006060000	351,55 TL	62
9006120000	2.479,00 TL	61
9006220000	3.409,00 TL	61
9006230000	3.409,00 TL	61
9006450000	3.888,00 TL	60
9006890000	24,30 TL	62
9007470000	4.485,00 TL	62
9007480000	4.876,00 TL	62
9008120000	2.670,00 TL	61
9008190000	3.800,00 TL	61
9008320000	115,00 TL	62
9008330000	115,00 TL	62
9008340000	137,70 TL	62
9008350000	197,65 TL	62
9008370000	137,70 TL	62
9008380000	144,20 TL	62
9008390000	176,60 TL	62
9008400000	176,60 TL	62
9008410000	217,10 TL	62
9008470000	115,00 TL	62
9008480000	144,20 TL	62
9008490000	197,65 TL	62
9008500000	309,40 TL	62
9008530000	150,65 TL	62
9008540000	200,90 TL	62
9008550000	312,65 TL	62
9008570000	183,05 TL	62
9008580000	218,70 TL	62
9008850000	456,85 TL	62
9008860000	302,95 TL	62
9008870000	348,70 TL	63
9008880000	390,40 TL	63
9008910000	183,05 TL	62
9009010000	200,90 TL	62
9009020000	137,70 TL	62
9009030000	102,05 TL	62
9009740000	859,00 TL	62
9009750000	1.092,00 TL	62
9010110000	126,35 TL	62
9011360000	3.043,00 TL	61
9011460000	2.527,00 TL	60
9012600000	2.527,00 TL	60
9013080000	3.645,00 TL	61
9013090000	3.645,00 TL	61
9013400000	3.745,00 TL	61
9013970000	447,10 TL	96
9014350000	2.233,00 TL	60</

Ürün Sıralı Listesi

Ürün Kodu	Birim Fiyat	Sayfa No
9027270000	7.038,00 €	66
9027290000	7.521,00 €	66
9027310000	28.360,00 €	66
9028480000	5.417,00 €	66
9028500000	19.680,00 €	66
9028510000	3.795,00 €	66
9028530000	22.305,00 €	66
9028540000	25.945,00 €	66
9028680000	3.120,00 TL	63
9028740000	3.509,00 TL	63
9030060000	416,75 TL	60
9030060000	416,75 TL	96
9030500000	654,00 TL	60
9032xx0000	Sorunuz	60
9037160000	90,70 TL	62
9037200000	0,270 TL	71
9037230000	0,284 TL	71
9037260000	0,284 TL	71
9037290000	0,284 TL	71
9037320000	1,02 TL	71
9037340000	1,27 TL	71
9037360000	1,55 TL	71
9037500000	0,335 TL	71
9037530000	0,838 TL	71
9046280000	341,80 TL	63
9046290000	367,75 TL	63
9046300000	396,90 TL	63
9046310000	341,80 TL	63
9046320000	367,75 TL	63
9046330000	414,70 TL	63
9046340000	536,00 TL	63
9046350000	317,50 TL	63
9046360000	317,50 TL	63
9046370000	345,05 TL	63
9046380000	351,55 TL	63
9046390000	392,40 TL	63
9046400000	396,90 TL	63
9046410000	437,40 TL	63
9046420000	440,65 TL	63
9046430000	437,40 TL	63

9200000000

9200070000	0,428 TL	72
9200080000	0,428 TL	72
9200090000	0,540 TL	72
9200100000	0,521 TL	72
9200110000	0,783 TL	72
9200150000	0,521 TL	72
9200170000	0,662 TL	72
9200180000	0,662 TL	72
9200190000	0,876 TL	72
9200200000	0,819 TL	72
9200230000	1,17 TL	72
9200240000	1,16 TL	72
9200250000	1,34 TL	72
9200260000	1,62 TL	72
9200290000	0,485 TL	72
9200300000	0,513 TL	72
9200310000	0,521 TL	72
9200320000	0,559 TL	72
9200330000	0,838 TL	72
9200360000	0,606 TL	72
9200370000	0,606 TL	72
9200380000	0,614 TL	72
9200390000	0,876 TL	72
9200410000	1,06 TL	72
9200420000	1,08 TL	72
9200430000	1,42 TL	72
9200440000	1,89 TL	72
9200460000	0,606 TL	73
9200470000	0,745 TL	73

Ürün Kodu	Birim Fiyat	Sayfa No
9200480000	1,42 TL	73
9200490000	0,614 TL	73
9200500000	0,726 TL	73
9200510000	1,17 TL	73
9200540000	0,652 TL	73
9200560000	0,707 TL	73
9200570000	0,987 TL	73
9200580000	0,606 TL	73
9200590000	0,671 TL	73
9200600000	0,932 TL	73
9200640000	0,707 TL	73
9200650000	0,764 TL	73
9200660000	1,19 TL	73
9201650000	3.599,00 TL	64
9202040000	5.848,00 TL	60
9202060000	8.502,00 TL	60
9202080000	16.047,00 TL	60
9202210000	3.814,00 TL	60
9202210000	3.814,00 TL	82
9202460000	17.940,00 TL	64
9202470000	1.364,00 TL	65
9202610000	6.633,00 TL	63
9202640000	2.340,00 TL	64
9202800000	4.513,00 TL	96
9202850000	2.479,00 TL	61
9202860000	5.770,00 TL	61
9203160000	10.724,00 TL	64
9204180000	760,00 TL	60
9204190000	975,00 TL	60
9204350000	898,00 TL	60
9205400000	888,00 TL	63
9205400000	888,00 TL	96
9205430000	14.820,00 TL	61
9205440000	14.820,00 TL	61
9205560000	859,00 TL	62

9400000000

9423580000	2.384,00 TL	63
9425830000	1.014,00 TL	63
9427300000	1.287,00 TL	63
9427370000	2.925,00 TL	63
9427460000	3.043,00 TL	63
9427520000	2.340,00 TL	63
9456050000	0,55 €	89
9456180000	79,70 €	86
9456190000	80,80 €	86
9456200000	81,90 €	86
9456210000	126,50 €	86
9456230000	164,50 €	86
9456320000	83,00 €	86
9456330000	97,20 €	86
9456340000	116,80 €	86
9456350000	161,60 €	86
9456370000	202,50 €	86
9456460000	115,80 €	86
9456470000	116,80 €	86
9456480000	117,90 €	86
9456490000	148,50 €	86
9456510000	195,50 €	86
9456600000	116,80 €	86
9456610000	118,00 €	86
9456620000	145,20 €	86
9456630000	183,40 €	86
9456650000	213,50 €	86
9456740000	119,00 €	86
9456750000	120,00 €	86
9456760000	121,20 €	86
9456770000	162,70 €	86
9456790000	215,00 €	86
9456880000	131,00 €	86
9456890000	136,50 €	86

Ürün Kodu	Birim Fiyat	Sayfa No
9456900000	177,00 €	86
9456910000	252,30 €	86
9456930000	254,40 €	86

9500000000

9512190000	169,20 TL	5
9512200000	320,20 TL	5
9512240000	63,10 TL	7
9512250000	91,80 TL	7
9512420000	169,20 TL	5
9531290000	115,70 TL	7
9532440000	55,90 TL	4
9532470000	13,00 TL	6
9535170000	17,50 €	68
9535210000	20,00 €	68
9535230000	18,70 €	68
9535290000	23,80 €	68
9535310000	24,85 €	68
9535330000	25,95 €	68
9535370000	30,05 €	68
9535430000	41,10 €	68
9535470000	48,65 €	68
9535690000	53,55 €	68
9535710000	69,00 €	68
9535730000	93,00 €	69
9535750000	95,15 €	69
9535770000	112,50 €	69
9535810000	215,00 €	69
9540000000	4,50 TL	5
9540000000	4,50 TL	14

9900000000

9918130000	241,40 TL	63
9918140000	236,50 TL	63
9918150000	241,40 TL	63
9918700000	3.370,00 €	60
9918840000	1.918,00 TL	64
9918840024	141,00 €	126
9918860000	745,00 TL	63
9918870000	1.710,00 TL	63
9918880000	674,00 TL	63
9918920000	900,00 TL	63
9918950000	243,00 TL	63
9928890005	106,50 €	123
9928890024	87,50 €	123

So00000000

Sorunuz	Sorunuz	57
Sorunuz	Sorunuz	57
Sorunuz	Sorunuz	57
Sorunuz	Sorunuz	57
Sorunuz	Sorunuz	57
Sorunuz	Sorunuz	132
Sorunuz	Sorunuz	132
Sorunuz	Sorunuz	132
Sorunuz	Sorunuz	132

Yetkili Bayilerimiz

ADANA

ÖZTEKNİK ENERJİ
Tel : (322) 359 30 60
Fax : (322) 394 47 44
E - mail : info@ozteknikenerji.com

ADAPAZARI

AKIŞIK
Tel : (264) 291 43 05
Fax : (264) 291 45 42
E - mail: akisikelektrik@gmail.com

ELPİM ELEKTRİK

Tel : (264) 276 00 83
Fax : (264) 275 19 00
E - mail: elpim@elpim.com.tr

ANKARA

ALPAN
Tel : (312) 354 96 63
Fax : (312) 354 96 66
E - mail: alpan@alpanelektrik.com

ARDA

Tel : (312) 385 80 37 (Ostim)
Fax : (312) 385 80 58
Tel : (312) 267 14 74 (Sincan)
E-mail: arda@ardaelektrik.com

BURSA

HARMES ELEKTRİK
Tel : (224) 443 04 52
Fax : (224) 443 04 53
E-mail: harmes@harmeselektrik.com

DENİZLİ

MATEK OTOMASYON
Tel : (258) 263 03 13
Fax : (258) 263 14 08
E - mail: info@matekotomasyon.com

ESKİŞEHİR

KIRAÇ ELEKTRİK
Tel : (222) 236 15 00
Fax : (222) 236 15 01
E-mail: kirac@kiracelektrik.com.tr

GAZİANTEP

GEYLANİ ENERJİ
Tel : (342) 215 30 60
Fax : (342) 215 30 64
E-mail: geylani@geylanienerji.com

İSTANBUL ANADOLU

ELSİS ELEKTRİK (ÜMRANİYE)
Tel : (216) 466 98 03
Fax : (216) 466 98 59
E-mail: info@elsiselektrik.com.tr

BOTEK ELEKTRİK ELEKTRONİK OTOMASYON (MALTEPE)

Tel : (216) 527 75 31
Fax : (216) 321 58 43
E-mail: botek@botekotomasyon.com

SARNİKON (ATAŞEHİR)

Tel : (212) 593 71 71
Fax : (212) 593 71 72
E-mail: info@sarnikon.com

İSTANBUL - AVRUPA

ERGİN ELEKTRİK (PERPA)
Tel : (212) 220 13 13
Fax : (212) 222 88 20
E-mail: danisma@ergin.com.tr

SOYLU OTOMASYON (İKİTELLİ)

Tel : (212) 671 33 56
Fax : (212) 671 33 60
E-mail: info@soyluotomasyon.com

ÜÇ - EL ELEKTRİK (KARAKÖY)

Tel : (212) 297 03 71
Fax : (212) 237 63 43
E-mail: ucel@uceelektrik.com.tr

VEGA ELEKTRİK (PERPA)

Tel : (212) 320 84 20
Fax : (212) 320 94 20
E-mail: info@vegaelektrik.com.tr

İZMİR

BOLEM ELEKTRİK
Tel : (232) 469 95 95
Fax : (232) 469 78 69
E-mail: bolem@bolemelk.com

TEM

Tel : (232) 441 61 11
Fax : (232) 457 44 75
E-mail: temelektrik@temelektrik.com

KOCAELİ

GENESİS OTOMASYON
Tel : (262) 323 26 06
Fax : (262) 321 58 43
E-mail: teklif@genesisotomasyon.com

KONYA

ŞALT OTOMASYON
Tel : (332) 345 31 81
Fax : (332) 345 31 84
E-mail: info@saltotomasyon.com

SAMSUN

GALİP MÜHENDİSLİK
Tel : (362) 435 27 13
Fax : (362) 431 50 05
E-mail: galip@galip.com.tr

TEKİRDAĞ

BOTEM BOBİNAJ (ÇORLU)
Tel : (282) 652 33 56
Fax : (282) 653 21 68
E-mail: info@botem.com.tr

Otomasyon Partnerlerimiz

ADANA

BOYSAN MÜHENDİSLİK (ADANA)
Tel : (322) 453 49 63
Fax : (322) 453 98 10
E-Mail : boysan@boysan.com.tr

ESKİŞEHİR

ANOT (ESKİŞEHİR)
Tel : (222) 236 16 16
Fax : (222) 236 16 11
E-mail: bilgi@anot.com.tr

GAZİANTEP

BİRMAG (GAZİANTEP)
Tel : (342) 215 05 04
Fax : (342) 215 05 99
E-mail:birmag@birmag.com

KONYA

SİMKON (KONYA)
Tel : (332) 346 16 00
Fax : (332) 346 16 02
E-mail: info@simkonmuhendislik.com

İSTANBUL ANADOLU

SGS AUTOMATION & DRIVES (GEBZE)
Tel : (262) 641 63 43
Fax : (262) 641 72 62
E-mail: sgs@sgsteknik.com

İZMİR

Pi OTOMASYON
Tel : (232) 435 42 77
Fax : (232) 435 42 71
E-mail: info@piotomasyon.com.tr

Satış Koşulları

Fiyat Listesi için geçerli olan Genel satış koşullarımıza; www.weidmuller.com.tr adresindeki "Fiyat Listesi" bölümünden ulaşabilirsiniz.

Weidmüller, elektriksel veri aktarımı ve güç bağlantı teknolojisi komponentleri alanında uzun yıllara dayanan tecrübesiyle en köklü üreticilerden biridir. Ürün portföyümüz ray ve baskılı devre klemensleri, sanayi tipi fiş-soketler, röle ve optokuplörler, sinyal dönüştürücüleri, güç kaynakları, aşırı gerilim koruma modülleri ve daha birçok ürün grubunu içermekte ve tüm endüstriyel kullanım alanlarına uygunluk göstermektedir.

Elektrik tesisat ve markalama ürünleri, I/O modülleri ve el aletleri seçenekleri ile ürün yelpazemiz tamamlanmaktadır. Weidmüller, endüstriyel bağlantı teknolojisi alanındaki inovasyon odaklı yenilikçi çalışmalarıyla, global standartların oluşturulmasında öncü rol oynamaktadır.

Dünya Çapındaki Adreslerimiz

Let's Connect.

Satış Organizasyonu



Yurtdışı Temsilciliği



Distribütör

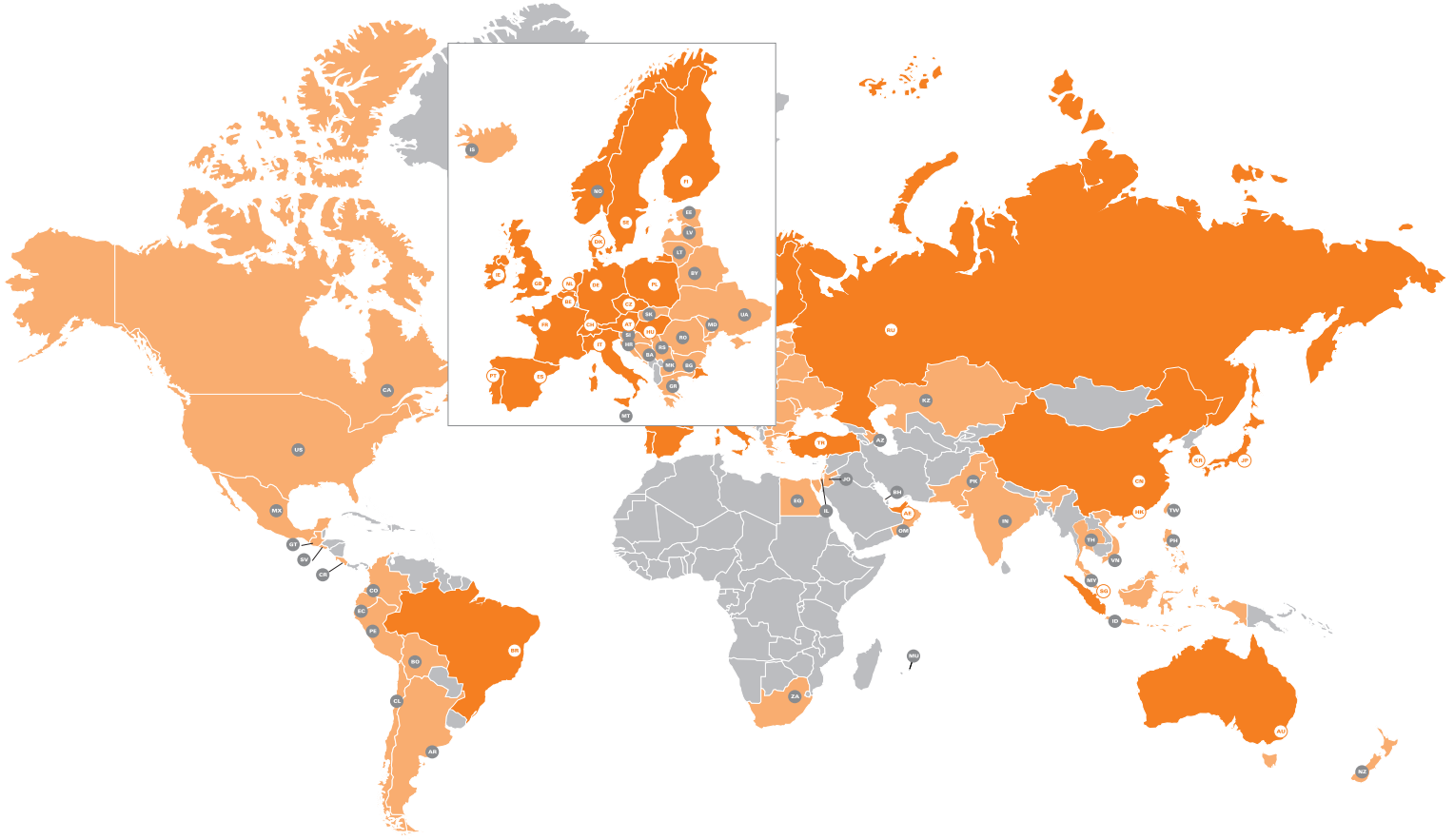

Weidmüller Elektronik Ticaret Ltd. Şti. | Çubuklu Mah. Orhan Veli Kanık Cad. 9, 34805 Beykoz - İstanbul, Turkey

Tel. 0216 537 10 70 | **Faks** 0216 537 10 77 | **E-mail:** info@weidmuller.com.tr | www.weidmuller.com.tr

■ **Adana / Gaziantep Bölge**

Tel. 0533 764 48 43

■ **Kocaeli Bölge**

Tel. 0533 295 39 88

■ **Ankara Bölge**

Tel. 0533 348 49 62

■ **Konya Bölge**

Tel. 0530 978 98 47

■ **Bursa Bölge**

Tel. 0530 978 98 46

■ **Samsun Bölge**

Tel. 0534 890 11 28

■ **İzmir Bölge**

Tel. 0530 236 37 50