



**ORTAC®**

Kablo Bağlantı Elemanları

**KABLO KORUMA, TAŞIMA & SONLANDIRMA SİSTEMLERİ**



*Güvenli Bağlantılar Kurar...*



# ORTAC®

Polyamide  
Halogen Free  
V2 - V0

Permanent operational time -40 C° to +100 C°  
Short term operational time +150 C°

Yüksek ısı ve darbe dayanımlı kapak  
Head piece that resistance to  
high temperature and compression

Her noktadan eşit 360 sıkma özelliği  
360 equal clamping range in every point

DIN normuna uygun bağlantı dişi  
PG 40430 / Metrik EN 60423  
AG thread that is acceptable DIN norm  
PG 40430 / Metrik EN 60423

%30 cam elyaf katkılı ısı ve darbe  
dayanımlı altı köşe somun  
%30 glass fiber reinforced lock nut  
that resistance to high temperature  
and compression



Vibrasyonlu ortamlarda gevşeme  
önleyici kilitleme sistem  
Lock system that prevent slackening  
in vibrational areas



TVP Kauçuk conta  
IP 68 (su, toz geçirmez) sızdırmazlık özelliği  
UV ultraviyole ışınlarla dayanımlı  
TPV rubber seal  
IP 68  
UV

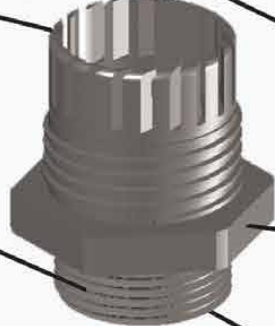

Yüksek ısı ve darbeye dayanımlı gövde  
Body part that resistance to high  
temperature and compression



Kablo geçiş esnasında takılma önleyici  
kaygan zemin  
There is a slickness ground that prevent  
cable's hung on

Kaymayı önleyici kumlamalı yüzey  
Roughngng surface that prevent gliding





## KABLO RAKORLARI VE AKSESUARLARI

Polyamid Kablo Rakorları .....	05 - 06
Tubeğland, Körtapa, Somunlar, O-Ringler .....	07
Pirinç Kablo Rakorları .....	08 - 09
ORvent Havalandırma Nem Rakorları ve Tapaları .....	10
Pirinç Düz Tip Rakorlar, Pirinç Körtapa Somun .....	12

## EXPROOF KABLO RAKORLARI & AKSESUARLARI

ATEX Kodlama .....	14
Zırhlı Kablo Rakorları (DCG - ACG) .....	15
Zırhsız Kablo Rakorları (UAG) .....	16
Kablo Tutuculu Spiral Rakoru, Topraklama Ekipmanı, Kılıf .....	17
Exproof Körtapalar .....	18
Exproof Redüksiyon Adaptör .....	19
Endüstriyel Tip Zırhlı/Zırhsız Kablo Rakorları .....	20

## PANO MONTAJ EKİPMANLARI

Sıra Klemensler, Soket Klemensler, Porselen Klemensler .....	22
Pano İçi Delikli Kablo Kanalları, Kapalı Tip Kablo Kanalları .....	23
Kablo Çorapları, Montaj Rayları, Müşterek Bara Sistemleri .....	24
Motor Klemensleri, Motor Pervaneleri ve Klemens Kutuları .....	25
İzolatörler .....	26
Isıyla Daralan ve Paslanmaz Kablo Bağları .....	27 - 28

## SİRAL BORULAR & AKSESUARLARI

Polyamide Spiral Borular .....	30
Polyamide Spiral Rakorları ve Aksesuarları .....	31 - 32
Dişli PVC Spiral Boruları ve Aksesuarları .....	33
İzoleli - İzolesiz Galvaniz Çelik Spiraller .....	34 - 35
Çelik Spiral Boru Rakorları .....	36 - 37
Hareketli Kablo Taşıyıcıları (ORTAC) .....	38 - 40

## EMT / IMC BORU & AKSESUARLARI

EMT/IMC Boru ve Aksesuarları .....	42 - 45
EX Aydınlatma Armatürleri ve Buatlar .....	46

## KABLO BAĞLARI, YÜKSÜK & SKP'ler

SKP Pabuç ve Dağıtıcı Üniteler .....	47
U Klemensler, Kablo Bağları .....	48
Yüksük ve Aksesuarları .....	49 - 50

## INFINITY, SİNYAL VE KUMANDA BUTONLARI

Metal Seri Kumanda Butonları .....	52
Plastik Seri Kumanda Butonları ve Sinyal Lambaları .....	53
Kumanda Kutuları ve Revizyon Kutuları .....	54
IP Konnektörler .....	55
Koruma Sınıfları & Sertifikalar .....	56



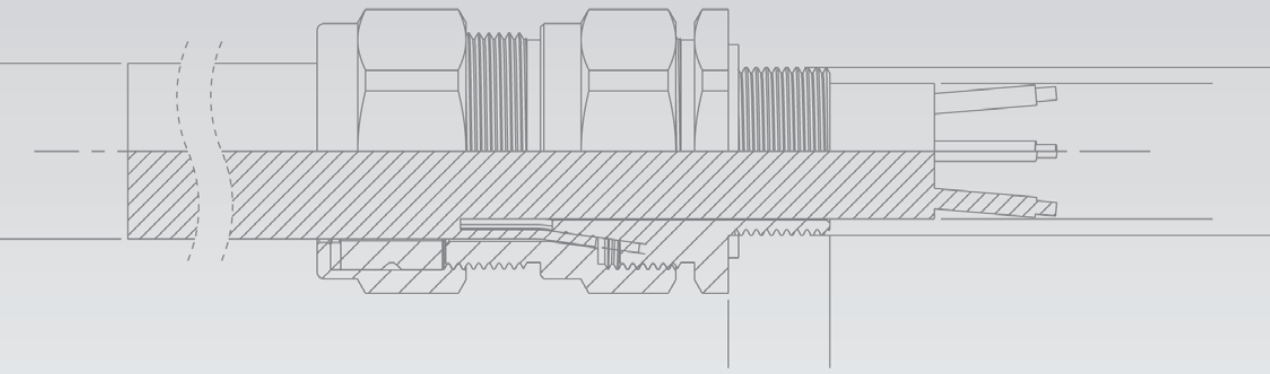

# We Establish Safety Connection In Hazardous Areas



**TUV NORD**  
TS EN ISO 9001 : 2008



**ORTAC**   
CABLE GLANDS & ACCESSORIES

## MÜŞTEREK BARA SİSTEMLERİ

KOD	CİNSİ	KALINLIK	AKIM A. mm	ÖLÇÜ	MODÜL
TMB 10A	3 KUTUPLU İĞNE TİP TRİFAZE	1	80	53 cm	10
TMB 10B	3 KUTUPLU İĞNE TİP TRİFAZE	1.5	100	53 cm	10
TMB 110A	3 KUTUPLU İĞNE TİP TRİFAZE	1	80	106 cm	20
TMB 110B	3 KUTUPLU İĞNE TİP TRİFAZE	1.5	100	106 cm	20
TRİFAZE YAN KAPAK	-	-	-	-	-
MMB 10A	1 KUTUPLU İĞNE TİP MONOFAZE	1	80	53 cm	30
MMB 10B	1 KUTUPLU İĞNE TİP MONOFAZE	1.5	100	53 cm	30
MMB 110A	1 KUTUPLU İĞNE TİP MONOFAZE	1	80	106 cm	56
MMB 110B	1 KUTUPLU İĞNE TİP MONOFAZE	1.5	100	106 cm	56



## NÖTR TOPRAKLAMA BARA SİSTEMLERİ

KOD	CİNSİ	KALINLIK	MODÜL	PAPUÇ
NTK31A	NÖTR TOPRAKLAMA BARASI	1.5	15x1mt.31 Vida	31
NTK31B	NÖTR TOPRAKLAMA BARASI	2	15x1mt.31 Vida	31
NTK 62A	NÖTR TOPRAKLAMA BARASI	1.5	15x1mt.61 Vida	61
NTK 62B	NÖTR TOPRAKLAMA BARASI	2	15x1mt.61 Vida	61
BM 01	BARA MESNEDİ	-	-	-

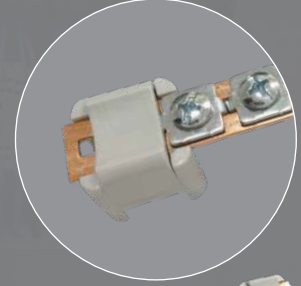

## W OTOMAT RAYLARI

KOD	A mm	H mm	B mm	L cm
ODSR02	35	7.5	1	100
ODSR03	35	7.5	1	200
ODSR04	35	7.5	1	300
ODSR06	35	7.5	1	100
ODSR07	35	7.5	1	200
ODSR08	35	7.5	1	300
RTS	RAY AYAK SAC			
RTA	RAY AYAK ALÜMİNYUM			

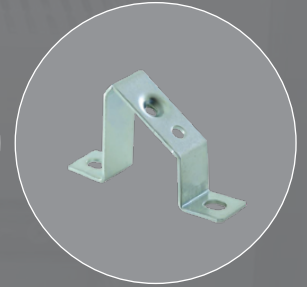
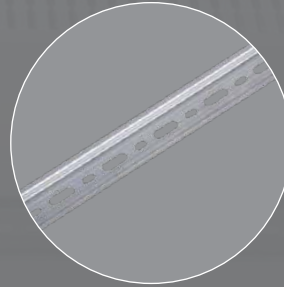

DÜZ OTOMAT RAYI

DELİKLİ OTOMAT RAYI

RAY AYAKI



## Neden ORvent?

- ORTAC , ORvent ürün gurubu ile aydınlatma ,Solar,endüstriyel uygulamalar sektörlerindeki değişim ve gelişimi görüp bu sektördeki üreticilerin ihtiyaç duyduğu tamamlayıcı ürünlerin dünya standartlarında ve teknolojisinde üreterek dışa bağımlılıklarını ortadan kaldırarak üreticilerimizin dünya pazarındaki rekabet gücünü arttırmaktadır.
- ORTAC ORvent basınç dengeleme sistemleri havalandırma nem rakorları ve tapalarını ürün gamına eklemiştir. Dış mekan led armatürleri çevre şartlarına dayanıklı olması gerekmektedir. Çevre şartlarına karşı dayanıklılığını arttırmak için etkili bir çözümü ORvent ventil rakor ve tapalar sunmaktadır. ORvent ventil rakor ve tapalar suz ve toz geçirmez olup geçirdiği hava ile armatür kasasında oluşan basıncı dengeler armatürün ömrünü uzatır Kolay pratik ve ekonomik çözüm sunar.
- Harici ortam sıcaklıklarındaki yağmur,kar ve buna bağlı ani ısı değişimleri basınç farklılıklarına sebep olur.basınç farklılıklarına neden olan bir diğer etken ise led armatür veya elektrik bağlantı kutularının açılış-kapanış ve hava,deniz yolu ile üretim yerinden montaj yerine ulaşımı esnasında kendi içinde gösterdiği sıcaklık değişimlerine bağlı basınç sapmalarıdır.
- Led armatür veya elektrik bağlantı kutularındaki basınç sabit tutma zorluğu ve buna önlem almak adına izole edilmeleri işçilik ve ekonomik açıdan pahalı bir çözüm olmaktadır. Tüm bu işlemler aynı zamanda ürünün toplam ağırlığını arttırır ve herhangi bir arıza durumunda tamir işlemini zorlaştırır.
- İklim farklılıkları beraberinde getirdiği hava değişimlerinden dolayı oluşan basınç farklılıkları led armatür ve elektrik bağlantı kutularının içinde bağıl neme bağlı yoğuşmaya sebep olur.ventil rakor ve tapa kullanılan ürünlerde oluşan nem hızlı bir şekilde tahliye edildiği için yoğuşma görülmemiştir.
- Orvent ventil rakor ve tapaları tüm bu zorlukları ortadan kaldırır ve ekonomik çözüm sunduğu gibi cihazın ömrünü uzatır.

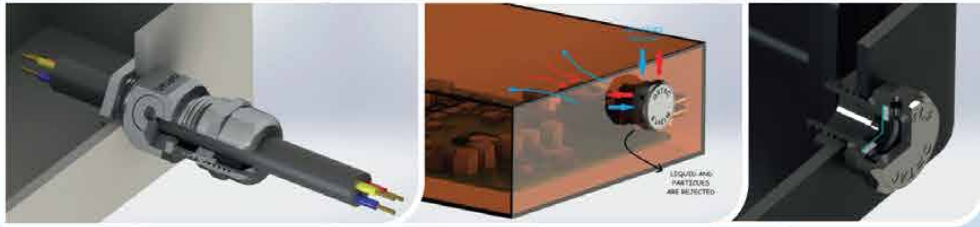

## ORvent BASINÇ Dengeleme BİLEŞENLERİ

- Cihazın içindeki basıncın artmasını engeller
- Hava sirkülasyonunu sağlayarak ısı yükselişini engeller
- Ortamdaki neme bağlı oluşabilecek olumsuz etkileri minimuma indirir hatta tamamen etkisizleştirir
- Havalandırma rakorları GAZ, BUHAR,HAVA gibi elementleri geçirgen olup SU ve Toz geçirmez.
- Aydınlatma ürünlerindeki neme bağlı yoğunlaşma ve buharlaşma sorununu ortadan kaldırarak periyodik temizlik maliyetlerini minimuma indirir ve ürün ömrünü uzatır

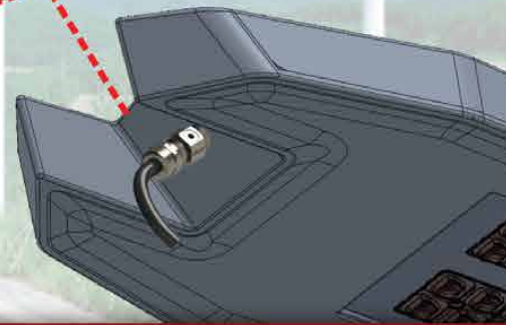
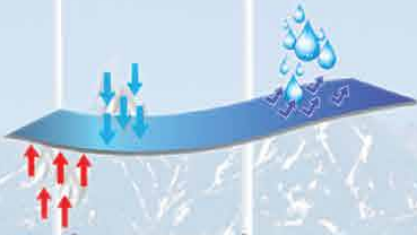

**STANDART ETANJ TİP KABLO RAKORLARI (Somunlu)**
**PG Serisi**

Boy	Gri Kodu	Siyah Kodu	Montaj Çap/mm.	Diş Uzunluğu mm.	Sıkma Çapı mm.	Koli Miktarı	Kutu Adedi	Birim Fiyatı TL
PG 7	ORG 01	ORB 01	13	8	3-6,5	4000	400	0,68
PG 9	ORG 02	ORB 02	16	8	4-8	3000	300	0,76
PG 11	ORG 03	ORB 03	19	8	5-10	3600	200	0,94
PG 13,5	ORG 04	ORB 04	21	9	6-12	2700	150	1,03
PG 16	ORG 05	ORB 05	23	9	10-14	2250	125	1,24
PG 21	ORG 06	ORB 06	29	11	13-18	1350	75	1,84
PG 29	ORG 07	ORB 07	37,5	11	18-25	300	30	3,35
PG 36	ORG 08	ORB 08	47,5	13	22-32	200	20	5,72
PG 42	ORG 09	ORB 09	54,5	13	30-38	150	15	7,51
PG 48	ORG 10	ORB 10	60	14	34-44	80	8	8,46

**Metrik Serisi**

M 12	OMRG 01	OMRB 01	12,5	8	3-6,5	4000	400	0,70
M 16 K	OMRG 02	OMRB 02	16,5	8	4-8	3000	300	0,84
M 16	OMRG 03	OMRB 03	16,5	10	5-10	3600	200	0,95
M 20 K	OMRG 04	OMRB 04	20,5	10	6-12	2700	150	1,10
M 20	OMRG 05	OMRB 05	20,5	10	10-14	2250	125	1,27
M 25	OMRG 06	OMRB 06	25,5	10	13-18	1350	75	1,89
M 32	OMRG 07	OMRB 07	32,5	10	18-25	400	40	3,97
M 40	OMRG 08	OMRB 08	40,5	10	22-32	200	20	6,46
M 50	OMRG 09	OMRB 09	50,5	18	30-38	150	15	8,27
M 63	OMRG 10	OMRB 10	63,5	18	34-44	80	8	10,70

**KAPALI CANTALI ETANJ TİP KABLO RAKORLARI (Somunlu)**
**PG Serisi**

PG 7	KRG 01	KRB 01	13	8	3-6,5	-	400	0,87
PG 9	KRG 02	KRB 02	16	8	4-8	-	300	0,97
PG 11	KRG 03	KRB 03	19	8	5-10	-	200	1,17
PG 13,5	KRG 04	KRB 04	21	9	6-12	-	150	1,30
PG 16	KRG 05	KRB 05	23	9	10-14	-	125	1,56
PG 21	KRG 06	KRB 06	29	11	13-18	-	75	2,35
PG 29	KRG 07	KRB 07	37,5	11	18-25	-	30	4,25
PG 36	KRG 08	KRB 08	47,5	13	22-32	-	20	7,24
PG 42	KRG 09	KRB 09	54,5	13	30-38	-	15	9,49
PG 48	KRG 10	KRB 10	60	14	34-44	-	8	10,68

**Metrik Serisi**

M 12	KMRG 01	KMRB 01	12,5	8	3-6,5	-	400	0,89
M 16 K	KMRG 02	KMRB 02	16,5	8	4-8	-	300	1,05
M 16	KMRG 03	KMRB 03	16,5	10	5-10	-	200	1,21
M 20 K	KMRG 04	KMRB 04	20,5	10	6-12	-	150	1,40
M 20	KMRG 05	KMRB 05	20,5	10	10-14	-	125	1,62
M 25	KMRG 06	KMRB 06	25,5	10	13-18	-	75	2,38
M 32	KMRG 07	KMRB 07	32,5	10	18-25	-	40	5,02
M 40	KMRG 08	KMRB 08	40,5	10	22-32	-	20	8,18
M 50	KMRG 09	KMRB 09	50,5	18	30-38	-	15	10,46
M 63	KMRG 10	KMRB 10	63,5	18	34-44	-	8	13,54

**UZUN DIŞ ETANJ TİP KABLO RAKORLARI (Somunlu)**
**PG Serisi**

PG 7	ORGL 01	ORBL 01	13	15	3-6,5	-	400	0,95
PG 9	ORGL 02	ORBL 02	16	15	4-8	-	250	1,05
PG 11	ORGL 03	ORBL 03	19	15	5-10	-	200	1,27
PG 13,5	ORGL 04	ORBL 04	21	15	6-12	-	150	1,41
PG 16	ORGL 05	ORBL 05	23	15	10-14	-	125	1,71
PG 21	ORGL 06	ORBL 06	29	15	13-18	-	75	2,54

**Metrik Serisi**

M 12	OMRG 01 L	OMRB 01 L	12,5	15	3-6,5	-	400	0,97
M 16 K	OMRG 11 S	OMRB 11 S	16,5	15	4-8	-	250	1,13
M 16	OMRG 11	OMRB 11	16,5	15	5-10	-	200	1,30
M 20 K	OMRG 12	OMRB 12	20,5	15	6-12	-	150	1,51
M 20	OMRG 13	OMRB 13	20,5	15	10-14	-	125	1,75
M 25	OMRG 14	OMRB 14	25,5	15	13-18	-	75	2,59
M 32	OMRG 15	OMRB 15	35,5	18	18-25	-	30	5,45
M 40	OMRG 16	OMRB 16	40,5	18	22-32	-	20	9,30



**SİRAL UÇLU ETANJ TİP KABLO RAKORLARI (Somunlu)**
**PG Serisi**

Boy	Gri Kodu	Siyah Kodu	Kutu Adedi	Montaj Çap/mm.	Diş Uzunluğu mm.	Sıkma Çapı mm.	Birim Fiyatı TL
PG 7	ORG 19	ORB 19	200	13	8	3-6,5	1,64
PG 9	ORG 20	ORB 20	150	16	8	4-8	1,73
PG 11	ORG 21	ORB 21	100	19	8	5-10	2,14
PG 13,5	ORG 22	ORB 22	75	21	9	6-12	2,37
PG 16	ORG 23	ORB 23	50	23	9	10-14	3,02
PG 21	ORG 24	ORB 24	30	29	11	13-18	4,51
<b>Metrik Serisi</b>							
M 12	OMRG 17	OMRB 17	200	12,5	8	3-6,5	1,64
M 16 K	OMRG 18	OMRB 18	150	16,5	8	4-8	1,73
M 16	OMRG 19	OMRB 19	100	16,5	10	5-10	2,14
M 20 K	OMRG 20	OMRB 20	75	20,5	10	6-12	2,37
M 20	OMRG 21	OMRB 21	50	20,5	10	10-14	3,02
M 25	OMRG 22	OMRB 22	30	25,5	10	13-18	4,51

**EUROMETRİK ETANJ TİP KABLO RAKORLARI (Somunlu) ÖZEL**
**Özel Çap**

M 25	OMRG E6	OMRB E6	75	25,5	10	11-17	2,48
M 32	OMRG E7	OMRB E7	40	32,5	10	15-21	5,22
M 40	OMRG E8	OMRB E8	20	40,5	10	19-28	8,51
<b>Uzun Diş</b>							
M 25	OMRG E14	OMRB E14	75	25,5	15	11-17	3,41
M 32	OMRG E15	OMRB E15	40	32,5	15	15-21	7,19
M 40	OMRG E16	OMRB E16	20	40,5	15	19-28	11,68

**SR TİP ETANJ KABLO RAKORLARI (Somunlu)**
**(Soketli Kablolar İçin)**

PG 21	ORG 06-SR05	ORB 06-SR05	75	29	11	5	5,40
PG 21	ORG 06-2SR05	ORB 06-2SR05	75	29	11	2 x 5	6,21
M 25	OMRG 06-SR05	OMRB 06-SR05	75	25,5	10	5	5,40
M 25	OMRG 06-2SR05	OMRB 06-2SR05	75	25,5	10	2 x 5	6,21

**ES SERİSİ ETANJ TİP REDÜKSİYONLU KABLO RAKORLARI (Somunlu)**
**Metrik Serisi**

M25	OMRG ES4	OMRB ES4	75	25,5	10	4-10	4,70
M 25	OMRG ES6	OMRB ES6	75	25,5	10	6-12	4,70

**DÜZ TİP KABLO RAKORLARI (Somunlu)**
**PG Serisi**

PG 7	ORL 11	400	13	8	3,5-6	0,74
PG 9	ORL 12	300	16	8	4,5-7	0,82
PG 11	ORL 13	200	19	8	6-9	1,01
PG 13,5	ORL 14	150	21	9	9-12	1,11
PG 16	ORL 15	125	23	9	11-14	1,34
PG 21	ORL 16	75	29	11	14-18	1,99
PG29	ORL 17	30	37,5	11	18-25	3,70
PG 36	ORL 18	20	47,5	13	25-32	6,17

**ÇOK DELİKLİ MULTİ CONTALAR**



Kod	Plastik Bo y	Delik Adedi	Ölçü mm.	Poşet Miktarı	Metal Bo y	Birim Fiyatı TL
MEC02A3	PG9/M16K	2	3	20	PG9/M16	
MEC03A3	PG9/M16K	3	3	20	PG9/M16	
MEC02C3	PG9/M16K	4	3	20	PG9/M16	
MEC03A4	PG11/M16	2	4	20	PG11	
MEC03A5	PG11/M16	2	5	20	PG11/M20	
MEC03B5	PG11/M16	3	5	20	PG11/M20	
MEC04A6	PG13,5/M20K	2	6	20	PG13,5	
MEC04B5	PG13,5/M20K	3	5	20	PG13,5	
MEC05A4	PG16/M20	2	4	20	PG16/M25	
MEC05A7	PG16/M20	2	7	20	PG16/M25	
MEC05B6	PG16/M20	3	6	20	PG16/M25	
MEC05C5	PG16/M20	4	5	20	PG16/M25	
MEC06A9	PG21/M25	2	9	20	PG21/M32	
MEC06B7	PG21/M25	3	7	20	PG21/M32	
MEC06B8	PG21/M25	3	8	20	PG21/M32	
MEC06C7	PG21/M25	4	7	20	PG21/M32	
MEC06G4	PG21/M25	8	4	20	PG21/M32	
MEC07C9	PG29/M32	4	9	20	OG29/M40	
MEC07D3	PG29/M32	16	3	20	OG29/M40	
MEC08E8	PG36/M40	6	8	20	OG29/M40	



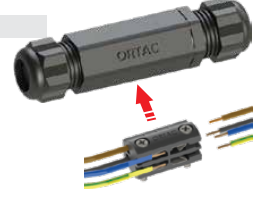

**IP 68 BAĞLANTI KONNEKTÖRÜ**
**Tube gland**

Boy	Siyah Kodu	Sıkma Aralığı		Kutu Adedi	Birim Fiyatı (Seperatörlü) TL	Birim Fiyatı (Klemensli) TL
		A	B			
M 25 x 1,5	OTG 01	11-17	11-17	100	14,08	17,75
M 25 x 1,5	OTG 03	11-17	9-14	100	14,08	17,75
M 25 x 1,5	OTG 06	9-14	9-14	100	14,08	17,75
M 25 x 1,5	OTG 09	9-14	6-12	100	14,08	17,75

**Aydınlatma Uygulamalarında Hızlı - Pratik - Güvenli  
Kablo Birleştirme Konnektörü**
**POLYAMİD KÖRTAPA**
**PG Serisi**

Boy	Gri Kodu	Siyah Kodu	Kutu Adedi	Montaj Çap/mm.	Birim Fiyatı TL
PG 7	OGK 01	OBK 01	100	13	0,40
PG 9	OGK 02	OBK 02	100	16	0,44
PG 11	OGK 03	OBK 03	100	19	0,46
PG 13,5	OGK 04	OBK 04	100	21	0,57
PG 16	OGK 05	OBK 05	100	23	0,73
PG 21	OGK 06	OBK 06	50	29	0,87
PG 29	OGK 07	OBK 07	25	37,5	1,46
PG 36	OGK 08	OBK 08	25	47,5	2,11

**Metrik Serisi**

M 12	MOGK 01	MOBK 01	100	12,5	0,44
M 16	MOGK 02	MOBK 02	100	16,5	0,46
M 20	MOGK 03	MOBK 03	100	20,5	0,65
M 25	MOGK 04	MOBK 04	50	25,5	0,84
M 32	MOGK 05	MOBK 05	25	32,5	0,97
M 40	MOGK 06	MOBK 06	25	40,5	2,16

**POLYAMİD SOMUN (CAM ELYAF KATKILI)**
**PG Serisi**
**POLYAMİD SOMUN (CAM ELYAF KATKILI)**
**Metrik Serisi**

Boy	Gri Kodu	Siyah Kodu	Kutu Adedi	Wrench	Birim Fiyatı TL
PG 7	OSG 01	OSB 01	100	19	0,27
PG 9	OSG 02	OSB 02	100	22	0,27
PG 11	OSG 03	OSB 03	100	24	0,29
PG 13,5	OSG 04	OSB 04	100	27	0,35
PG 16	OSG 05	OSB 05	100	30	0,37
PG 21	OSG 06	OSB 06	50	36	0,59
PG 29	OSG 07	OSB 07	25	46	1,08
PG 36	OSG 08	OSB 08	25	60	1,75
PG 42	OSG 09	OSB 09	10	65	2,11
PG 48	OSG 10	OSB 10	10	70	3,13

Bo y	Gri Kodu	Siyah Kodu	Kutu Adedi	Wrench	Birim Fiyatı TL
M 12	MSG 01	MSB 01	100	18	0,29
M 16	MSG 02	MSB 02	100	22	0,40
M 20	MSG 03	MSB 03	100	26	0,59
M 25	MSG 04	MSB 04	50	32	0,65
M 32	MSG 05	MSB 05	25	41	1,08
M 40	MSG 06	MSB 06	25	50	1,94
M 50	MSG 07	MSB 07	10	60	2,94
M 63	MSG 08	MSB 08	10	75	4,40

**ETANJ RAKOR TAPALARI**

PG 7 M 12	PTB 01	0,16
PG 9 M 16	PTB 02	0,17
PG 11 M 16	PTB 03	0,21
PG 13 M 20	PTB 04	0,25
PG 16 M 20	PTB 05	0,27
PG 21 M 25	PTB 06	0,41
PG 29 M 32	PTB 07	0,49
PG 36 M 40	PTB 08	0,64
PG 42 M 50	PTB 09	0,73
PG 48 M 63	PTB 10	0,98

**Toz Önleyici Tapa**
**KAUÇUK KÖRTAPA**

PG 13,5	OKKG 01	100	17	0,57
PG 16	OKKG 02	100	22,8	0,76
PG 21	OKKG 03	100	28,6	0,93
PG 29	OKKG 04	100	37,3	1,19
PG 36	OKKG 05	50	47	3,93
PG 42	OKKG 06	50	55	5,12

**KABLO RAKORU O-RİNGİ**

M 12-PG7	100	-
M 16-PG9	100	-
M 20-PG13,5 - PG 11	100	-
M 25-PG21 - PG 16	100	-
M 40-PG29 - M 32	100	-
M 50-PG36 - PG 42	50	-
M 63-PG48	50	-

**KABLO RAKORU YASSI RONDELA**

RN-TPV-M12	PG7-M12	100	-
RN-TPV-M16	PG9-M16	100	-
RN-TPV-M20	PG11-M20K	100	-
RN-TPV-M20-2	PG13,5-M20	100	-
RN-TPV-M25	PG16-M25	100	-
RN-TPV-M32	PG21-M32	50	-
RN-TPV-M40	PG29-M40	25	-
RN-TPV-M50s	PG36-M50s	25	-
RN-TPV-M50	PG42-M50	25	-
RN-TPV-M63	PG48-M63	25	-



**PİRİNÇ NİKEL KAPLI KABLO RAKORLARI (Somunlu)**
**PG Serisi**

Boy	Kod	Kutu Adedi	Montaj Çap/mm.	Diş Uzunluğu mm.	Sıkma Çapı mm.	Birim Fiyatı TL
PG 7	OPBG 01	100	13	6	3-6,5	4,55
PG 9	OPBG02	50	16	6	4-8	5,99
PG 11	OPBG 03	50	19	6	5-10	6,56
PG 13,5	OPBG 04	50	21	6,5	6-12	7,51
PG 16	OPBG 05	50	23	6,5	10-14	8,65
PG 21	OPBG 06	25	29	7	13-18	14,76
PG 29	OPBG 07	20	37,5	8	18-25	26,67
PG 36	OPBG 08	10	47,5	10	22-32	45,04
PG 42	OPBG 09	5	54,5	12	30-38	56,04
PG 48	OPBG 10	5	60	14	34-44	70,72

**Metrik Serisi**

M 12	OMBG 01	100	12,5	6	3-6,5	4,59
M 16	OMBG 02	50	16,5	7	4-8	6,08
M 20	OMBG 03	50	20,5	8	6-12	8,27
M 25	OMBG 04	25	25,5	8	10-14	10,43
M 25	OMBG 04/06	25	25,5	8	13-18	14,76
M 32	OMBG 05	20	32,5	9	13-18	17,46
M 40	OMBG 06	10	40,5	9	18-25	34,70
M 50	OMBG 07	5	50,5	9	22-32	58,53
M 63	OMBG 08	5	63,5	14	34-44	83,19
M 63B	OMBG 17	5	63,5	15	44-55	130,90
M 72	OMBG 17s	5	72,5	20	45-55	147,00
M 75	OMBG 18	5	76	20	50-63	238,70
M 80	OMBG 18-80	5	80,5	20	50-63	238,70
M 90	OMBG 19	5	91	20	60-70	367,00

**PİRİNÇ NİKEL KAPLI KABLO RAKORLARI (Somunlu) UZUN DİŞ**
**PG Serisi**

PG 7	OPBG 11	50	13	10	3-6,5	6,38
PG 9	OPBG 12	50	16	10	4-8	8,52
PG 11	OPBG 13	50	19	10	5-10	9,18
PG 13,5	OPBG 14	50	21	10	6-12	10,51
PG 16	OPBG 15	50	23	10	10-14	12,11
PG 21	OPBG 16	50	29	12	13-18	20,67
PG 29	OPBG 17	20	37,5	12	18-25	37,34
PG 36	OPBG 18	15	47,5	14	22-32	63,05
PG 42	OPBG 19	10	54,5	18	30-38	78,45
PG 48	OPBG 20	5	60	18	34-44	99,01

**Metrik Serisi**

M 12	OMBG 09	50	12,5	12	3-6,5	6,43
M 16	OMBG 10	50	16,5	12	4-8	8,54
M 20	OMBG 11	50	20,5	12	6-12	11,58
M 25	OMBG 12	50	25,5	12	10-14	14,60
M 25	OMBG 12/06	50	25,5	12	13-18	20,67
M 32	OMBG 13	20	32,5	14	13-18	24,45
M 40	OMBG 14	15	40,5	14	18-25	48,58
M 50	OMBG 15	10	50,5	14	22-32	81,94
M 63	OMBG 16	5	63,5	18	34-44	117,48

**MINI GLAND PİRİNÇ NİKEL KAPLI KABLO RAKORLARI (Somunlu) KISA TİP**
**PG Serisi**
**STANDART RAKOR**

M12 x 1,5

**MINI RAKOR**

M12 x 1,5

PG7	MGP7-24	-	13	6	2-4	5,73
PG7	MGP7-35	-	13	6	3-5	5,73
PG9	MGP9-46	-	16	6	4-6	5,73
PG9	MGP9-68	-	16	6	6-8	5,73

**Metrik Serisi**

M8	MGM8s-35	-	8,5	6	3-5	5,73
M8	MGM8- 24	-	8,5	6	2-4	5,73
M10	MGM10s- 46	-	10,5	6	4-6	5,73
M10	MGM10- 24	-	10,5	6	2-4	5,73
M10	MGM10- 36	-	10,5	6	3-6	5,73
M12	MGM12- 24	-	12,5	6	2-4	5,73
M12	MGM12- 36	-	12,5	6	3-6	5,73



● Kablo ve montaj çaplarına göre özel boy üretilmektedir.

**PASLANMAZ ÇELİK KABLO RAKORLARI (Somunlu) AISI 303**

PG Serisi

Boy	Kod	Kutu Adedi	Montaj Çap/mm.	Diş Uzunluğu mm.	Sıkma Çapı mm.	Birim Fiyatı TL
PG 7	OPSG 01	100	13	6	3-6,5	92,23
PG 9	OPSG 02	50	16	6	4-8	92,23
PG 11	OPSG 03	50	19	6	5-10	102,62
PG 13,5	OPSG 04	50	21	6,5	6-12	109,01
PG 16	OPSG 05	50	23	6,5	10-14	121,08
PG 21	OPSG 06	25	29	7	13-18	167,77
PG 29	OPSG 07	20	37,5	8	18-25	218,15
PG 36	OPSG 08	10	47,5	10	22-32	277,97
PG 42	OPSG 09	5	54,5	12	30-38	358,14
PG 48	OPSG 10	5	60	14	34-44	438,15

**Metrik Serisi**

M 12	OMSG 01	100	12,5	6	3-6,5	93,66
M 16	OMSG 02	50	16,5	7	4-8	93,66
M 20	OMSG 03	50	20,5	8	6-12	103,19
M 25	OMSG 04	25	25,5	8	10-14	152,10
M 25	OMSG 04/06	25	25,5	8	13-18	167,77
M 32	OMSG 05	20	32,5	9	13-18	200,00
M 40	OMSG 06	15	40,5	9	18-25	260,35
M 50	OMSG 07	5	50,5	9	22-32	310,00
M 63	OMSG 08	5	63,5	14	34-44	473,00

**SR TİP PİRİNÇ NİKEL KAPLI KABLO RAKORLARI (Somunlu)**

Soketli Kablolar İçin

PG 21	OPBG 06-SR5	25	29	7	5	19,21
PG 21	OPBG 06-2SR5	25	29	7	2 x 5	20,15
M 32	OMBG 06-SR5	25	32,5	9	5	23,70
M 32	OMBG 06-2SR5	25	32,5	9	2 x 5	24,89

**SİRAL UÇLU PİRİNÇ NİKEL KAPLI KABLO RAKORLARI (Somunlu)**

PG Serisi

PG 7	STPG 01	100	13	6	3-6,5	34,56
PG 9	STPG 02	50	16	6	4-8	40,96
PG 11	STPG 03	50	19	6	5-10	47,39
PG 13,5	STPG 04	50	21	6,5	6-12	58,32
PG 16	STPG 05	50	23	6,5	10-14	62,58
PG 21	STPG 06	25	29	7	13-18	75,96

**Metrik Serisi**

M 12	STCG 01	100	12,5	6	3-6,5	34,67
M 16	STCG 02	50	16,5	7	4-8	41,64
M 20	STCG 03	50	20,5	8	6-12	59,80
M 25	STCG 04	50	25,5	8	10-14	63,53
M 32	STCG 05	25	32,5	8	13-18	77,12

**EMC TİP TOPRAKLAMALI PİRİNÇ NİKEL KAPLI KABLO RAKORLARI (Somunsuz)**

PG Serisi

						Birim Fiyatı €
PG 7	OPBT 01	100	13	6	3-6,5	2,02
PG 9	OPBT 02	50	16	6	4-8	2,28
PG 11	OPBT 03	50	19	6	5-10	2,60
PG 13,5	OPBT 04	50	21	6,5	6-12	2,86
PG 16	OPBT 05	50	23	6,5	10-14	3,32
PG 21	OPBT 06	25	29	7	13-18	5,40
PG 29	OPBT 07	20	37,5	8	18-25	8,46
PG 36	OPBT 08	10	47,5	10	22-32	14,00
PG 42	OPBT 09	5	54,5	12	30-38	18,81
PG 48	OPBT 10	5	60	14	34-44	23,05

**Metrik Serisi**

M 12	OMBT 01	100	12,5	6	3-6,5	1,86
M 16	OMBT 02	50	16,5	7	4-8	2,17
M 20	OMBT 03	50	20,5	8	6-12	2,76
M 25	OMBT 04	25	25,5	8	10-14	3,53
M 32	OMBT 05	20	32,5	9	13-18	5,89
M 40	OMBT 06	10	40,5	9	18-25	8,46
M 50	OMBT 07	5	50,5	9	22-32	23,00
M 63	OMBT 08	5	63,5	14	34-44	33,60



# ORvent

## BASINÇ DENGELEME BİLEŞENLERİ

### HAVALANDIRMA TAPALARI (Polyamide – Pirinç – Paslanmaz)



Boy	Kod	Cinsi	Ortalama Hava Geçirgen	Su Sızdırmazlık Basıncı MBar	Kutu Adedi	Birim Fiyatı €
M4x0,7	OMBVP4S	Pirinç	6	0,1	100	2,88
M4x0,7	OMSVP4S	Paslanmaz	6	0,1	100	6,13
M8x1,25	OMBVP8S	Pirinç	5,5	0,1	100	2,88
M8x1,25	OMSVP8S	Paslanmaz	5,5	0,1	100	6,13
M10x1,5	OMBVP10S	Pirinç	5,5	0,1	100	2,88
M10x1,5	OMSVP10S	Paslanmaz	5,5	0,1	100	6,13
M 12	OMPVG01SL	Polyamide	16	0,8	100	1,19
M 12	OMBVP01SL	Pirinç	16	0,8	100	3,39
M 12	OMSVP01SL	Paslanmaz	16	0,8	100	6,83

### HAVALANDIRMA KABLO RAKORU (Polyamide)



Boy	Kod Gri	Kod Siyah	Montaj Çapı	GL	H	Sıkma Aralığı	Ortalama Hava Geçirgen	Su Sızdırmazlık Basıncı MBar	Kutu Miktarı	Birim Fiyatı €
M12	OMVGL 01	OMVGB 01	12,5	8	29	4-6,5	70	0,1	100	1,98
M16	OMVGL 02	OMVGB 02	16,5	10	33	4-8	70	0,1	100	1,98
PG7	OPVGL 01	OPVGB 01	13	8	29	4-6,5	70	0,1	100	1,98
PG9	OPVGL 02	OPVGB 02	16	8	33	4-8	70	0,1	100	1,98
PG13,5	OPVGL 03	OPVGB 03	21	6,5	35	6-12	70	0,1	100	3,31
M20	OMVGL 03	OMVGB 03	20,5	8	35	6-12	70	0,1	100	3,31

### HAVALANDIRMA KABLO RAKORU (Pirinç – Paslanmaz)



Boy	Kod Pirinç	Kod Paslanmaz	Montaj Çapı	GL	H	Sıkma Aralığı	Ortalama Hava Geçirgen	Su Sızdırmazlık Basıncı MBar	Kutu Miktarı	Pirinç Birim Fiyatı €	Paslanmaz Birim Fiyatı €
M12	OMBVGL01	OMSVGL01	12,3	6	31,5	4-8	70	0,1	100	5,32	12,22
M12	OMBVGL01L	OMSVGL01L	12,3	8	31,5	4-8	70	0,1	100	5,32	12,22
M16	OMBVGL02R	OMSVGL02R	16,3	6	31,5	4-8	70	0,1	100	5,32	12,22
M16	OMBVGL02RL	OMSVGL02RL	16,3	8	31,5	4-8	70	0,1	100	5,32	12,22
M16	OMBVGL02	OMSVGL02	16,3	6	31,5	5-10	70	0,1	100	5,32	12,22
M16	OMBVGL02L	OMSVGL02L	16,3	8	31,5	5-10	70	0,1	100	5,32	13,80
M20	OMBVGL03	OMSVGL03	20,3	8	35	6-12	70	0,1	100	6,04	14,66
PG7	OPBVGL01	OPSVGL01	13	6	31,5	4-8	70	0,1	100	5,32	12,22
PG7	OPBVGL01L	OPSVGL01L	13	8	31,5	4-8	70	0,1	100	5,32	12,22
PG9	OPBVGL02	OPSVGL02	16	6	31,5	4-8	70	0,1	100	5,32	12,22
PG9	OPBVGL02L	OPSVGL02L	16	8	31,5	4-8	70	0,1	100	5,32	12,22
PG11	OPBVGL03	OPSVGL03	19	6	31,5	5-10	70	0,1	100	5,32	12,22
PG11	OPBVGL03L	OPSVGL03L	19	8	31,5	5-10	70	0,1	100	5,61	13,80
PG13,5	OPBVGL04	OPSVGL04	21	6,5	35	6-12	70	0,1	100	6,04	14,66
PG13,5	OPBVGL04L	OPSVGL04L	21	8	35	6-12	70	0,1	100	6,04	14,66



## Neden ORvent?

- ORTAC , ORvent ürün gurubu ile aydınlatma ,Solar,endüstriyel uygulamalar sektörlerindeki değişim ve gelişimi görüp bu sektördeki üreticilerin ihtiyaç duyduğu tamamlayıcı ürünlerin dünya standartlarında ve teknolojisinde üreterek dışa bağımlılıklarını ortadan kaldırarak üreticilerimizin dünya pazarındaki rekabet gücünü arttırmaktadır.
- ORTAC ORvent basınç dengeleme sistemleri havalandırma nem rakorları ve tapalarını ürün gamına eklemiştir. Dış mekan led armatürleri çevre şartlarına dayanıklı olması gerekmektedir. Çevre şartlarına karşı dayanıklılığını arttırmak için etkili bir çözümü ORvent ventil rakor ve tapalar sunmaktadır. ORvent ventil rakor ve tapalar suz ve toz geçirmez olup geçirdiği hava ile armatür kasasında oluşan basıncı dengeler armatürün ömrünü uzatır Kolay pratik ve ekonomik çözüm sunar.
- Harici ortam sıcaklıklarındaki yağmur,kar ve buna bağlı ani ısı değişimleri basınç farklılıklarına sebep olur.basınç farklılıklarına neden olan bir diğer etken ise led armatür veya elektrik bağlantı kutularının açılış-kapanış ve hava,deniz yolu ile üretim yerinden montaj yerine ulaşımı esnasında kendi içinde gösterdiği sıcaklık değişimlerine bağlı basınç sapmalarıdır.
- Led armatür veya elektrik bağlantı kutularındaki basınç sabit tutma zorluğu ve buna önlem almak adına izole edilmeleri işçilik ve ekonomik açıdan pahalı bir çözüm olmaktadır. Tüm bu işlemler aynı zamanda ürünün toplam ağırlığını arttırır ve herhangi bir arıza durumunda tamir işlemini zorlaştırır.
- İklim farklılıkları beraberinde getirdiği hava değişimlerinden dolayı oluşan basınç farklılıkları led armatür ve elektrik bağlantı kutularının içinde bağıl neme bağlı yoğuşmaya sebep olur.ventil rakor ve tapa kullanılan ürünlerde oluşan nem hızlı bir şekilde tahliye edildiği için yoğuşma görülmemiştir.
- Orvent ventil rakor ve tapaları tüm bu zorlukları ortadan kaldırır ve ekonomik çözüm sunduğu gibi cihazın ömrünü uzatır.

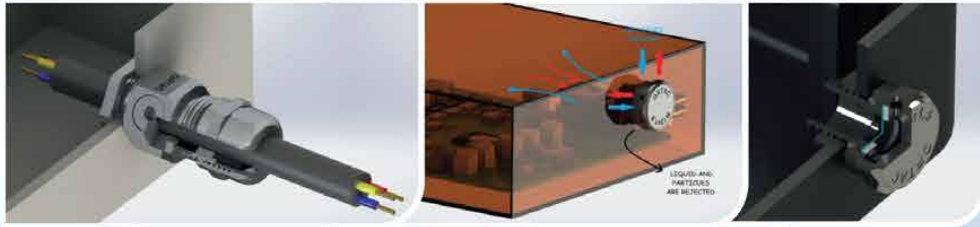

## ORvent BASINÇ Dengeleme BİLEŞENLERİ

- Cihazın içindeki basıncın artmasını engeller
- Hava sirkülasyonunu sağlayarak ısı yükselişini engeller
- Ortamdaki neme bağlı oluşabilecek olumsuz etkileri minimuma indirir hatta tamamen etkisizleştirir
- Havalandırma rakorları GAZ, BUHAR,HAVA gibi elementleri geçirgen olup SU ve Toz geçirmez.
- Aydınlatma ürünlerindeki neme bağlı yoğunlaşma ve buharlaşma sorununu ortadan kaldırarak periyodik temizlik maliyetlerini minimuma indirir ve ürün ömrünü uzatır

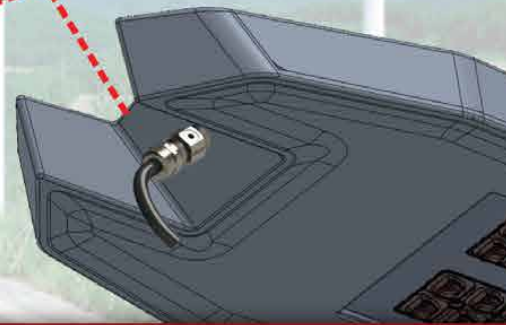
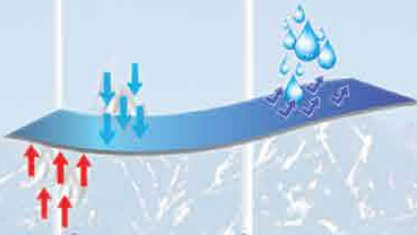

**PİRİNÇ NİKEL KAPLI KABLO RAKORLARI (Somunlu) ÖZEL UZUN DIŞ**
**PG Serisi**

Boy	Kod	Kutu Adedi	Montaj Çap/mm.	Diş Uzunluğu mm.	Sıkma Çapı mm.	Birim Fiyatı TL
PG 7	OPBGL 01	50	13	25	3-6,5	12,18
PG 9	OPBGL 02	50	16	25	4-8	15,35
PG 11	OPBGL 03	50	19	25	5-10	16,14
PG 13,5	OPBGL 04	50	21	25	6-12	18,45
PG 16	OPBGL 05	50	23	25	10-14	21,30
PG 21	OPBGL 06	50	29	25	13-18	36,37
PG 29	OPBGL 07	20	37,5	25	18-25	62,87

**Metrik Serisi**

M 12	OMBGL 01	50	12,5	25	3-6,5	12,38
M 16	OMBGL 02	50	16,5	25	4-8	15,62
M 20	OMBGL 03	50	20,5	25	6-12	19,49
M 25	OMBGL 04	50	25,5	25	10-14	25,67
M 25	OMBGL 04/06	50	25,5	25	13-18	36,37
M 32	OMBGL 05	20	32,5	25	13-18	43,15
M 40	OMBGL 06	15	40,5	25	18-25	81,79

**DÜZ / KELEPÇELİ TİP PİRİNÇ KABLO RAKORLARI (Somunlu)**
**Kaplamasız**

Boy	Düz Tip Kod	Kelepçeli Tip Kod	Kablo Çap/mm.	Montaj Çap mm.	Düz Tip Birim Fiyatı/ TL	Kelepçeli Tip Birim Fiyatı/ TL
PG 7	DOPR 01	OKPR 01	3-7	12,5	5,51	12,15
PG 9	DOPR 02	OKPR 02	6-9	15,5	6,42	13,28
PG 11	DOPR 03	OKPR 03	7-10	18,5	8,48	15,00
PG 13,5	DOPR 04	OKPR 04	8-11	20,5	10,43	18,76
PG 16	DOPR 05	OKPR 05	10-14	22,5	13,52	21,72
PG 21	DOPR 06	OKPR 06	14-19	28,5	20,13	29,68
PG Ø 25	DOPR Ø 25	OKPR Ø 25	18-24	32	32,00	42,64
PG 29	DOPR 07	OKPR 07	23-28	37,5	39,21	64,05
PG 36	DOPR 08	OKPR 08	28-34	47	63,17	91,02
PG 42	DOPR Ø 09	OKPR 09	35-41	55	80,33	105,00
PG 48	DOPR Ø 10	OKPR 10	38-44	60	110,00	144,50
Ø 55	DOPR Ø 55	OKPR Ø 55	43-48	65	137,00	153,00
Ø 60	DOPR Ø 60	OKPR Ø 60	47-54	70	184,65	203,00
Ø 70	DOPR Ø 70	OKPR Ø 70	55-63	80	234,00	267,00
Ø 80	DOPR Ø 80	OKPR Ø 80	64-72	90	301,67	325,00
Ø 90	DOPR Ø 90	OKPR Ø 90	74-82	100	500,00	538,00
Ø 100	DOPR Ø 100	OKPR Ø 100	85-91	110	552,00	655,00
Ø 125	DOPR Ø 125	OKPR Ø 125	92-109	135	1047,80	1183,00
Ø 150	DOPR Ø 150	OKPR Ø 150	115-130	170	1674,59	2029,69



\*Ürünler Kaplamasızdır. Kaplamalı Fiyatı İsteyiniz.

**PİRİNÇ KÖRTAPA (Nikelli)**
**PG Serisi**

Boy	Kod	Kutu Adedi	Montaj Çap/mm.	Birim Fiyat TL
PG 7	OPBK 01	100	13	3,38
PG 9	OPBK 02	50	16	3,84
PG 11	OPBK 03	50	19	4,37
PG 13,5	OPBK 04	50	21	5,41
PG 16	OPBK 05	50	23	6,64
PG 21	OPBK 06	25	29	8,03
PG 29	OPBK 07	20	37,5	12,40
PG 36	OPBK 08	10	47,5	23,42
PG 42	OPBK 09	5	54,5	29,51
PG 48	OPBK 10	5	60	34,77

**Metrik Serisi**

M 12	OMBK 01	100	12,5	3,06
M 16	OMBK 02	50	16,5	3,84
M 20	OMBK 03	50	20,5	4,71
M 25	OMBK 04	25	25,5	7,02
M 32	OMBK 05	20	32,5	10,22
M 40	OMBK 06	10	40,5	15,29
M 50	OMBK 07	5	50,5	24,37
M 63	OMBK 08	5	63,5	36,89

**PİRİNÇ SOMUN (Nikelli)**
**PG Serisi**

Boy	Kod	Kutu Adedi	Anahtar Ağız/mm.	Birim Fiyat TL
PG 7	OPBL 01	100	15	0,79
PG 9	OPBL 02	50	18	0,86
PG 11	OPBL 03	50	21	0,98
PG 13,5	OPBL 04	50	23	1,32
PG 16	OPBL 05	50	26	1,38
PG 21	OPBL 06	25	32	1,97
PG 29	OPBL 07	20	40	3,00
PG 36	OPBL 08	10	50	5,68
PG 42	OPBL 09	5	60	9,67
PG 48	OPBL 10	5	64	10,72

**Metrik Serisi**

M 12	OMBL 01	100	15	0,86
M 16	OMBL 02	50	19	1,32
M 20	OMBL 03	50	24	1,68
M 25	OMBL 04	25	30	2,10
M 32	OMBL 05	20	36	2,86
M 40	OMBL 06	10	45	5,16
M 50	OMBL 07	5	55	9,95
M 63	OMBL 08	5	68	12,57



# We Establish Safety Connection In Hazardous Areas



**ORTAC** **Ex**  
CABLE GLANDS & ACCESSORIES



## PART NUMBERING

W	Without Certification (Industrial)	
DCG	Name Of Gland	
B	Brass	
N	Nickel Plating	
Sa	AISI303 Stainless Steel	
Sb	AISI304 Stainless Steel	
Sc	AISI316L Stainless Steel	
A	Aluminium	
	TPV Seal (-30 / +100 °c)	
1	PA6 V0 Washer (-40 / +100 °c)	1a
	PA6 V0 Upper Washer (-40 / +100 °c)	
2	Nbr Seal (-30 / +100 °c)	
	PA6 V0 Washer (-40 / +100 °c)	2a
	PA6 V0 Upper Washer (-40 / +100 °c)	
3	Neoprene Seal (-40 / +100 °c)	
	PA6 V0 Washer (-40 / +100 °c)	3a 3a2
	PA6 V0 Upper Washer (-40 / +100 °c)	
4	Silicone Seal (-60 / +180 °c)	
	Silicone Washer (-60 / +180 °c)	4a
	Teflon Upper Silicone (-200 / +260 °c)	
*	Cable Dia.	
**	Thread Type	
K	Kit ( Earth Tag + Pvc Shroud)	
E	Earth Tag	
T	Tpv Shroud (halogen Free)	
P	Pvc Shroud	

Alternative Washer Options	
1a	Nbr Washer (-30 / +100 °c)
2a	Nbr Washer (-30 / +100 °c)
3a	Nbr Washer (-30 / +100 °c)
3a2	Neoprene Washer (-40 / +100 °c)
3b	Teflon Upper Washer (-200 / +260 °c)
4a	Teflon Upper Washer (-200 / +260 °c)

### Example Parts Numbering

DCGN1-32-M32	M32x1,5 Etna Serie Double Compression Brass Nickel Plated Ex Cable Glands
DCGN1-32-M32-K	M32x1,5 Etna Serie Double Compression Brass Nickel Plated Ex Cable Gland Kit
ACGSa2-32-M32	M32x1,5 Colima Serie Single Compression 303 Stainless Steel Ex Cable Glands
ACGSa2-32-M32-E	M32x1,5 Colima Serie Single Compression 303 Stainless Steel Ex Cable Glands + Earth Tag
DCGSc3-32-N1/2	NPT 1/2 Etna Serie Double Compression 316L Stainless Steel Ex Cable Glands + Shroud
DCGSc3-32-G1/2-t	GAS 1/2 Etna Serie Double Compression 316L Stainless Steel Ex Cable Glands + TPV Shroud
ACGSc3-32-P11s-Kt	PG11s Colima Serie Single Compression 316L Stainless Steel Ex Cable Glands + Kit (with TPV Shroud)

W	DCG	B	1	*	**	K	t
		N	2			E	p
		Sa	3				
		Sb	4				
		Sc					
		A					

WDCGN1-20-M20-t  
DCGN1-20-M20-t

DCGSc2-20-M20-K  
DCGSc2-20-M20-Kt

W D C G XX - X - X - X - X

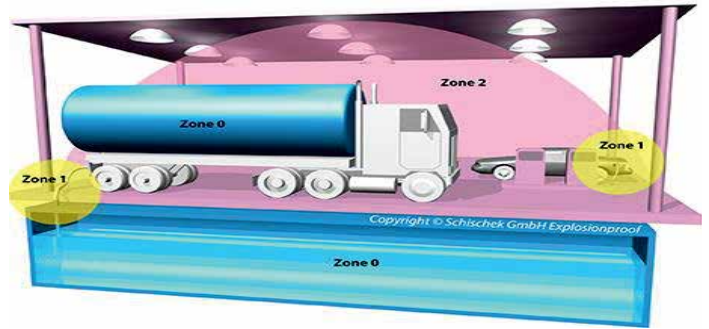
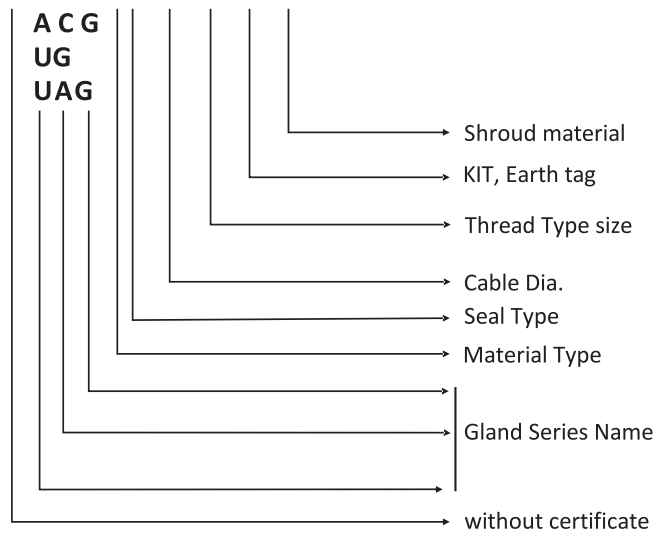



## DCG ÇİFT SIKMALI ZIRHLI KABLO RAKORLARI

### TECHNICAL DETAILS

Type	DCG (Double compression gland)
Protection Code	II 2G Exd/e IIC Gb II 1D Ex ta IIIC Da I M2 Exd/e I Mb
Certificate	IEP 14 ATEX 0216 U
Material	M558 Brass with or without nickel plated Stainless Steel AISI303 / 316L Aluminium
Standards	EN 60079-0:2009, 60079-1:2007, 60079-31:2009
Protection Class	EN60529 IP66 / 68
Temperature	-30 °C / +120 °C NBR -40 °C / +100 °C NEOPRENE -60 °C / +180 °C SILICONE -30 °C / +100 °C TPE/V
Application Area	ZONE1, ZONE2, ZONE21, ZONE22, Gas Groups IIA, IIB, IIC
Cable Type	SWA (Single Wire Armour)

## ETNA SERIES

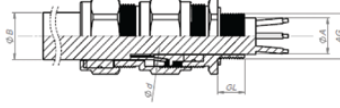

Product Size	Product Code	Standard AG	AG	AG	A		B		Ø d (Armour)		GL Min	Wrench
					Min	Max	Min	Max	Min	Max		
16	DCGXX/16/X	M16x1,5	1/2"	PG9	3,1	8,6	6,1	13,2	0,8	1,0	15	24
20ss	DCGXX/20ss/X	M20ssx1,5	1/2"	PG11ss	3,1	8,6	6,1	13,2	0,8	1,0	15	24
20s	DCGXX/20s/X	M20sx1,5	1/2"	PG11s	6,1	11,6	9,5	15,9	0,8	1,25	15	24
20	DCGXX/20/X	M20x1,5	1/2"	PG13,5	6,5	13,9	12,5	20,9	0,8	1,25	15	30
25s	DCGXX/25s/X	M25sx1,5	3/4"	PG21s	11,1	19,9	14	22	1,25	1,60	15	38
25	DCGXX/25/X	M25x1,5	3/4"	PG21	11,1	19,9	18,2	26,2	1,25	1,60	15	38
32	DCGXX/32/X	M32x1,5	1"	PG29	18,2	26,2	23,7	33,9	1,6	2,0	15	45
40	DCGXX/40/X	M40x1,5	1 1/4"	PG36s	23,7	33,9	27,9	40,4	1,6	2,0	15	55
50s	DCGXX/50s/X	M50sx1,5	1 1/2"	PG36	29,5	38,1	35,2	46,7	2,0	2,5	15	60
50	DCGXX/50/X	M50x1,5	2"	PG42	35,6	44,0	40,4	53,1	2,0	2,5	15	70
63s	DCGXX/63s/X	M63sx1,5	2"	PG48	40,1	49,9	45,6	59,4	2,0	2,5	15	75
63	DCGXX/63/X	M63x1,5	2 1/2"	-	47,2	55,9	54,6	65,9	2,0	2,5	15	80
75s	DCGXX/75s/X	M75sx1,5	2 1/2"	-	52,8	61,9	59	72,1	2,0	2,5	15	90
75	DCGXX/75/X	M75x1,5	3"	-	59,1	67,9	66,7	78,5	2,5	3,0	15	100
90	DCGXX/90/X	M90x2,0	3"	-	66,6	79,9	76,2	90,4	3,0	3,5	15	115
100	DCGXX/100/X	M100x2,0	-	-	76	90	86,1	101,5	3,15	4,0	15	123
115	DCGXX/115/X	M115x2,0	-	-	86	97,9	101,5	110,3	3,15	4,0	15	133
130	DCGXX/130/X	M130x2,0	-	-	97	114,9	114,2	123,3	3,15	4,0	15	146

## ACG TEK SIKMALI ZIRHLI KABLO RAKORLARI

### TECHNICAL DETAILS

Type	ACG (Armoured cable gland)
Protection Code	II 2G Exd/e IIC Gb II 1D Ex ta IIIC Da I M2 Exd/e I Mb
Certificate	IEP 14 ATEX 0215 U
Material	M558 Brass with or without nickel plated Stainless Steel AISI303 / 316L Aluminium
Standards	EN 60079-0:2009, 60079-1:2007, 60079-31:2009
Protection Class	EN60529 IP66 / 68
Temperature	-30 °C / +120 °C NBR -40 °C / +100 °C NEOPRENE -60 °C / +180 °C SILICONE -30 °C / +100 °C TPE/V
Application Area	ZONE1, ZONE2, ZONE21, ZONE22, Gas Groups IIA, IIB, IIC
Cable Type	SWA (Single Wire Armour)

## COLIMA SERIES

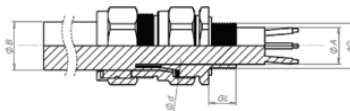

Product Size	Product Code	Standard AG	AG	AG	A		B	Ø d (Armour)		GL Min	Wrench
					Min	Min		Max	Min		
16	ACGXX/16/X	M16x1,5	1/2"	PG9	8,6	6,1	13,2	0,8	1,0	15	24
20ss	ACGXX/20ss/X	M20ssx1,5	1/2"	PG11ss	8,6	6,1	13,2	0,8	1,0	15	24
20s	ACGXX/20s/X	M20sx1,5	1/2"	PG11s	11,6	9,5	15,9	0,8	1,25	15	24
20	ACGXX/20/X	M20x1,5	1/2"	PG13,5	13,9	12,5	20,9	0,8	1,25	15	30
25s	ACGXX/25s/X	M25sx1,5	3/4"	PG21s	19,9	14	22	1,25	1,6	15	38
25	ACGXX/25/X	M25x1,5	3/4"	PG21	19,9	18,2	26,2	1,25	1,6	15	38
32	ACGXX/32/X	M32x1,5	1"	PG29	26,2	23,7	33,9	1,6	2,0	15	45
40	ACGXX/40/X	M40x1,5	1 1/4"	PG36s	33,9	27,9	40,4	1,6	2,0	15	55
50s	ACGXX/50s/X	M50sx1,5	1 1/2"	PG36	38,1	35,2	46,7	2,0	2,5	15	60
50	ACGXX/50/X	M50x1,5	2"	PG42	44,0	40,4	53,1	2,0	2,5	15	70
63s	ACGXX/63s/X	M63sx1,5	2"	PG48	49,9	45,6	59,4	2,0	2,5	15	75
63	ACGXX/63/X	M63x1,5	2 1/2"	-	55,9	54,6	65,9	2,0	2,5	15	80
75s	ACGXX/75s/X	M75sx1,5	2 1/2"	-	61,9	59	72,1	2,0	2,5	15	90
75	ACGXX/75/X	M75x1,5	3"	-	67,9	66,7	78,5	2,5	3,0	15	100
90	ACGXX/90/X	M90x2,0	3"	-	79,9	76,2	90,4	3,0	3,5	15	120
100	ACGXX/100/X	M100x2,0	-	-	90	86,1	101,5	3,15	4,0	15	130
115	ACGXX/115/X	M115x2,0	-	-	97,9	101,5	110,3	3,15	4,0	15	140
130	ACGXX/130/X	M130x2,0	-	-	114,9	114,2	123,3	3,15	4,0	15	150



## UAG ZIRHSIZ KABLO RAKORLARI



### TECHNICAL DETAILS

Type	UAG (Un-Ar) Armoured Gland
Protection Code	II 2G Exd/e IIC Gb II 1D Ex ta IIIC Da I M2 Exd/e I Mb
Certificate	IEP 14 ATEX 0217 U
Material	M58 Brass with or without nickel plated Stainless Steel AISI303 / 316L Aluminium
Standards	EN 60079-0:2009, 60079-1:2007, 60079-31:2009
Protection Class	EN60529 IP66 / 68
Temperature	-30 °C / +120 °C NBR -40 °C / +100 °C NEOPRENE -60 °C / +180 °C SILICONE -30 °C / +100 °C TPE/V
Application Area	ZONE1, ZONE2, ZONE21, ZONE22, Gas Groups IIA, IIB, IIC
Cable Type	Unarmoured

## MERAPI SERIES

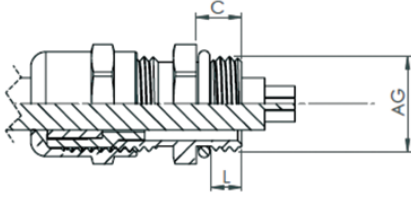

Product Size	Product Code	Standard AG	AG	GL min. mm	Clamping Range mm	 B mm C	
--------------	--------------	-------------	----	------------	-------------------	---	--

### Exd

12	UAGXX/12/X	M12x1,5	3/8"	15	3-6,5	14	14
16	UAGXX/16/X	M16x1,5	3/8"	15	4-8	18	17
20	UAGXX/20/X	M20x1,5	1/2"	15	6-12	22	22
25s	UAGXX/25s/X	M25x1,5	3/4"	15	10-14	27	24
25	UAGXX/25/X	M25x1,5	3/4"	15	13-18	30	30
32	UAGXX/32/X	M32x1,5	1"	15	13-18	34	30
40	UAGXX/40/X	M40x1,5	1 1/4"	15	18-25	43	40
50	UAGXX/50/X	M50x1,5	1 1/2"	15	22-32	55	50
63s	UAGXX/63s/X	M63x1,5	2"	15	33-44	68	64
63	UAGXX/63/X	M63x1,5	2"	15	45-50	70	75
75s	UAGXX/75s/X	M75x1,5	2 1/2"	20	45-55	85	75
75	UAGXX/75/X	M75x1,5	2 1/2"	20	50-63	90	90
80	UAGXX/80/X	M80x2,0	3"	20	50-63	90	90
90	UAGXX/90/X	M90x2,0	3"	20	60-70	100	100

### Exe

12	EUAGXX/12/X	M12x1,5	3/8"	6	3-6,5	14	14
16	EUAGXX/16/X	M16x1,5	3/8"	7	4-8	18	17
20	EUAGXX/20/X	M20x1,5	1/2"	8	6-12	22	22
25s	EUAGXX/25s/X	M25x1,5	3/4"	8	10-14	27	24
25	EUAGXX/25/X	M25x1,5	3/4"	8	13-18	30	30
32	EUAGXX/32/X	M32x1,5	1"	9	13-18	34	30
40	EUAGXX/40/X	M40x1,5	1 1/4"	9	18-25	43	40
50	EUAGXX/50/X	M50x1,5	1 1/2"	9	22-32	55	50
63s	EUAGXX/63s/X	M63x1,5	2"	14	33-44	68	64
63	EUAGXX/63/X	M63x1,5	2"	15	45-50	70	75
75s	EUAGXX/75s/X	M75x1,5	2 1/2"	20	45-55	85	75
75	EUAGXX/75/X	M75x1,5	2 1/2"	20	50-63	90	90
80	EUAGXX/80/X	M80x2,0	3"	20	50-63	90	90
90	EUAGXX/90/X	M90x2,0	3"	20	60-70	100	100

### TECHNICAL DETAILS

Type	UG (Un-Ar) Armoured Gland
Protection Code	II 2G Exd/e IIC Gb II 1D Ex ta IIIC Da IM2 Exd/e I Mb
Certificate	IEP 14 ATEX 0217 U
Material	M58 Brass with or without nickel plated Stainless Steel AISI303 / 316L Aluminium
Standards	EN 60079-0:2009 ,60079-1:2007,60079-31:2009
Protection Class	EN60529 IP66 / 68
Temperature	-30 °C / +120 °C NBR -40 °C / +100 °C NEOPRENE -60 °C / +180 °C SILICONE -30 °C / +100 °C TPE/V
Application Area	ZONE1, ZONE2, ZONE21, ZONE22, Gas Groups IIA, IIB, IIC
Cable Type	Unarmoured

## UG ZIRHSIZ KABLO RAKORLARI UNZEN SERIES

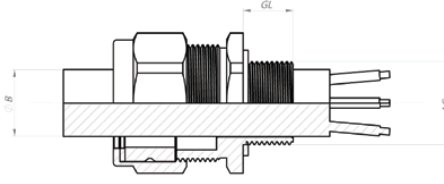

Product Size	Product Code	Standard AG	AG NPT	Min	B Max	GL	
16	UGXX/16/X	M16x1,5	1/2"	6,1	11,6	15	20-24
20s	UGXX/20s/X	M20sx1,5	1/2"	6,1	13,2	15	24
20	UGXX/20/X	M20x1,5	1/2"	9,5	15,9	15	24
25	UGXX/25/X	M25x1,5	3/4"	12,5	20,9	15	30
32	UGXX/32/X	M32x1,5	1"	18,2	26,2	15	38
40	UGXX/40/X	M40x1,5	1 1/4"	23,7	33,9	15	45
50	UGXX/50/X	M50x1,5	1 1/2"	27,9	40,4	15	55
63s	UGXX/63s/X	M63sx1,5	2"	40,4	51	15	70
63	UGXX/63/X	M63x1,5	2 1/2"	47,2	55,9	15	70-80
75s	UGXX/75s/X	M75sx1,5	2 1/2"	52,8	59	15	80
75	UGXX/75/X	M75x1,5	3"	59,1	67,9	15	90-100



## HARİCİ TİP KABLO TUTUCULU SİRAL RAKORU (Somunsuz)

Sabit Tip-IP67

PG Kod	Metrik Kod	Gas Kod	Siral Ölçü Dış Çap/mm.
Ex-MLSRP 1A	PG 9	10 - 1/4"	4-8
Ex-MLSRP 01	PG 11	13 - 3/8"	5-10
Ex-MLSRP 2A	PG 13,5	16 - 1/2"	6-12
Ex-MLSRP 02	PG 16	16 - 1/2"	10-14
Ex-MLSRP 03	PG 21	21 - 3/4"	13-18
Ex-MLSRP 04	PG 29	26 - 1"	18-25
Ex-MLSRP 05	PG 36	35 - 1 1/4"	22-32
Ex-MLSRP 06	PG 42	40 - 1 1/2"	30-38
Ex-MLSRP 07	PG 48	51 - 2"	34-44



### Metrik Dış

Ex-MLSRM	Metrik Kod	Gas Kod	Siral Ölçü Dış Çap/mm.
Ex-MLSRM 1A	M 16 X 1,5	10 - 1/4"	4-8
Ex-MLSRM01	M 16 X 1,5	13 - 3/8"	4-8
Ex-MLSRM 02	M 20 X 1,5	16 - 1/2"	6-12
Ex-MLSRM 03	M 25 X 1,5	21 - 3/4"	10-14
Ex-MLSRM 04	M 32 X 1,5	26 - 1"	13-18
Ex-MLSRM 05	M 40 X 1,5	35 - 1 1/4"	18-25
Ex-MLSRM 06	M 50 X 1,5	40 - 1 1/2"	22-32
Ex-MLSRM 07	M 63 X 1,5	51 - 2"	34-44

### TECHNICAL DETAILS

Type	MLS XX
Protection Code	II 2G Ex d IIC Gb / II 26 Ex e II C Gb II 1D Ex t6 III C Da IM2 Exd Imb & IM2 Exe I Mb
Certificate	IEP 15 ATEX 0355 X

### TOPRAKLAMA EKİPMANI

KOD	ÖLÇÜ
RTE-16	16
RTE-20	20
RTE-25	25
RTE-32	32
RTE-40	40
RTE-50	50
RTE-63	63
RTE-75	75
RTE-90	90
RTE-100	100
RTE-115	115
RTE-130	130



Material:

MS 58 with  
Nickel Plated  
Stainless Steel

### RAKOR KILIFI

KOD	ÖLÇÜ
PS-16	16/20ss/20s
PS-20	20
PS-25	25s/25
PS-32	32
PS-40	40
PS-50s	50s
PS-50	50
PS-63s	63s
PS-63	63
PS-75s	75s
PS-75	75
PS-90	90
PS-100	100
PS-115	115
PS-130	130



Material:

PVC / TPV



**TK SERİSİ** Körtapa



**TS SERİSİ** Körtapa



**TO SERİSİ** Körtapa



**TECHNICAL DETAILS**

Type	TK-XX / STOPPER PLUG
Protection Code	II 2G Exd/e IIC Gb II 1D Ex ta IIIC Da I M2 Ex d/e I Mb
Certificate	IEP 15 ATEX 0333 U

**TECHNICAL DETAILS**

Type	TS-XX / STOPPER PLUG
Protection Code	II 2G Exd/e IIC Gb II 1D Ex ta IIIC Da I M2 Ex d/e I Mb
Certificate	IEP 15 ATEX 0333 U

**TECHNICAL DETAILS**

Type	TO-XX / STOPPER PLUG
Protection Code	II 2G Exd/e IIC Gb II 1D Ex ta IIIC Da I M2 Ex d/e I Mb
Certificate	IEP 15 ATEX 0333 U

**KOD EBAT GL (mm)**

TK-XX/M12	M12 x 1,5	14
TK-XX/M16	M16 x 1,5	14
TK-XX/M20	M20 x 1,5	14
TK-XX/M25	M25 x 1,5	14
TK-XX/M32	M32 x 1,5	14
TK-XX/M40	M40 x 1,5	16
TK-XX/M50	M50 x 1,5	16
TK-XX/M63	M63 x 1,5	16
TK-XX/M75	M75 x 1,5	18
TK-XX/M90	M90 x 1,5	18
TK-XX/M110	M110 x 1,5	18
TK-XX/N14	NPT 1/4"	16
TK-XX/N38	NPT 3/8"	16
TK-XX/N12	NPT 1/2"	18
TK-XX/N34	NPT 3/4"	18
TK-XX/N100	NPT 1"	21
TK-XX/N114	NPT 1 1/4"	21
TK-XX/N112	NPT 1 1/2"	21
TK-XX/N200	NPT 2"	21
TK-XX/N212	NPT 2 1/2"	28
TK-XX/N300	NPT 3"	28
TK-XX/N400	NPT 4"	28
TK-XX/G14	G 1/4"	16
TK-XX/G38	G 3/8"	16
TK-XX/G12	G 1/2"	16
TK-XX/G34	G 3/4"	16
TK-XX/G100	G 1"	20
TK-XX/G114	G 1 1/4"	20
TK-XX/G112	G 1 1/2"	20
TK-XX/G200	G 2"	20
TK-XX/G212	G 2 1/2"	20
TK-XX/G300	G 3"	20
TK-XX/G400	G 4"	20
TK-XX/P7	PG7	15
TK-XX/P9	PG9	15
TK-XX/P11	PG 11	15
TK-XX/P13	PG 13,5	15
TK-XX/P16	PG16	15
TK-XX/P21	PG21	15
TK-XX/P29	PG29	15
TK-XX/P36	PG36	15
TK-XX/P42	PG42	15
TK-XX/P48	PG48	15

**KOD EBAT GL (mm)**

TS-XX-M12	M12 x 1,5	14
TS-XX-M16	M16 x 1,5	14
TS-XX-M20	M20 x 1,5	14
TS-XX-M25	M25 x 1,5	14
TS-XX-M32	M32 x 1,5	14
TS-XX-M40	M40 x 1,5	16
TS-XX-M50	M50 x 1,5	16
TS-XX-M63	M63 x 1,5	16
TS-XX-M75	M75 x 1,5	18
TS-XX-M90	M90 x 1,5	18
TS-XX-M110	M110 x 1,5	18
TS-XX-N14	NPT 1/4"	16
TS-XX-N38	NPT 3/8"	16
TS-XX-N12	NPT 1/2"	18
TS-XX-N34	NPT 3/4"	18
TS-XX-N100	NPT 1"	21
TS-XX-N114	NPT 1 1/4"	21
TS-XX-N112	NPT 1 1/2"	21
TS-XX-N200	NPT 2"	21
TS-XX-N212	NPT 2 1/2"	28
TS-XX-N300	NPT 3"	28
TS-XX-N400	NPT 4"	28
TS-XX-G14	G 1/4"	16
TS-XX-G38	G 3/8"	16
TS-XX-G12	G 1/2"	16
TS-XX-G34	G 3/4"	16
TS-XX-G100	G 1"	20
TS-XX-G114	G 1 1/4"	20
TS-XX-G112	G 1 1/2"	20
TS-XX-G200	G 2"	20
TS-XX-G212	G 2 1/2"	20
TS-XX-G300	G 3"	20
TS-XX-G400	G 4"	20
TS-XX-P7	PG7	15
TS-XX-P9	PG9	15
TS-XX-P11	PG 11	15
TS-XX-P13	PG 13,5	15
TS-XX-P16	PG16	15
TS-XX-P21	PG21	15
TS-XX-P29	PG29	15
TS-XX-P36	PG36	15
TS-XX-P42	PG42	15
TS-XX-P48	PG48	15

**KOD EBAT GL (mm) ALLEN**

TO-XX/M12	M12 x 1,5	15	6
TO-XX/M16	M16 x 1,5	15	8
TO-XX/M20	M20 x 1,5	15	10
TO-XX/M25	M25 x 1,5	15	10
TO-XX/M32	M32 x 1,5	15	10
TO-XX/M40	M40 x 1,5	15	10
TO-XX/M50	M50 x 1,5	15	10
TO-XX/M63	M63 x 1,5	15	12
TO-XX/M75	M75 x 1,5	15	12
TO-XX/M90	M90 x 1,5	15	12
TO-XX/M100	M100 x 1	15	12
TO-XX/N14	NPT 1/4"	15	6
TO-XX/N38	NPT 3/8"	15	8
TO-XX/N12	NPT 1/2"	15	10
TO-XX/N34	NPT 3/4"	15	10
TO-XX/N100	NPT 1"	15	10
TO-XX/N114	NPT 1 1/4"	15	10
TO-XX/N112	NPT 1 1/2"	15	10
TO-XX/N200	NPT 2"	15	12
TO-XX/N212	NPT 2 1/2"	15	12
TO-XX/N300	NPT 3"	15	12
TO-XX/N400	NPT 4"	15	12
TO-XX/G14	G 1/4"	15	6
TO-XX/G38	G 3/8"	15	8
TO-XX/G12	G 1/2"	15	10
TO-XX/G34	G 3/4"	15	10
TO-XX/G100	G 1"	15	10
TO-XX/G114	G 1 1/4"	15	10
TO-XX/G112	G 1 1/2"	15	10
TO-XX/G200	G 2"	15	12
TO-XX/G212	G 2 1/2"	15	12
TO-XX/G300	G 3"	15	12
TO-XX/G400	G 4"	15	12
TO-XX/P7	PG7	15	6
TO-XX/P9	PG9	15	8
TO-XX/P11	PG 11	15	10
TO-XX/P13	PG 13,5	15	10
TO-XX/P16	PG16	15	10
TO-XX/P21	PG21	15	10
TO-XX/P29	PG29	15	10
TO-XX/P36	PG36	15	12
TO-XX/P42	PG42	15	12
TO-XX/P48	PG48	15	12

**ATEX RC SERİSİ Redüksiyon** **ATEX RC SERİSİ Büyütücü Redüksiyon** **ATEX AP SERİSİ Adaptör**



**TECHNICAL DETAILS**

Type	RCXX / REDUCER
Protection Code	II 2G Exd/e IIC Gb II 1D Ex ta IIIC Da I M2 Ex d/e I Mb
Certificate	IEP 15 ATEX 0333 U
Application Area	ZONE1 , ZONE 2, ZONE 21 , ZONE 22 Gas groups IIA , IIB , IIC

**TECHNICAL DETAILS**

Type	RCXX / ENLARGER REDUCER
Protection Code	II 2G Exd/e IIC Gb II 1D Ex ta IIIC Da I M2 Ex d/e I Mb
Certificate	IEP 15 ATEX 0333 U
Application Area	ZONE1 , ZONE 2, ZONE 21 , ZONE 22 Gas groups IIA , IIB , IIC

**TECHNICAL DETAILS**

Type	APXX / ADAPTOR
Protection Code	II 2G Exd/e IIC Gb II 1D Ex ta IIIC Da I M2 Ex d/e I Mb
Certificate	IEP 15 ATEX 0333 U
Application Area	ZONE1 , ZONE 2, ZONE 21 , ZONE 22 Gas groups IIA , IIB , IIC

KOD	AG	IG
RCXX/M12m-M12f	M12 x 1,5	M12 x 1,5
RCXX/M12m-M16f	M12 x 1,5	M16 x 1,5
RCXX/M16m-M16f	M16 x 1,5	M16 x 1,5
RCXX/M12m-M20f	M12 x 1,5	M20 x 1,5
RCXX/M16m-M20f	M16 x 1,5	M20 x 1,5
RCXX/M20m-M20f	M20 x 1,5	M20 x 1,5
RCXX/M16m-M25f	M16 x 1,5	M25 x 1,5
RCXX/M20m-M25f	M20 x 1,5	M25 x 1,5
RCXX/M25m-M25f	M25 x 1,5	M25 x 1,5
RCXX/M20m-M32f	M20 x 1,5	M32 x 1,5
RCXX/M25m-M32f	M25 x 1,5	M32 x 1,5
RCXX/M32m-M32f	M32 x 1,5	M32 x 1,5
RCXX/M25m-M40f	M25 x 1,5	M40 x 1,5
RCXX/M32m-M40f	M32 x 1,5	M40 x 1,5
RCXX/M40m-M40f	M40 x 1,5	M40 x 1,5
RCXX/M32m-M50f	M32 x 1,5	M50 x 1,5
RCXX/M40m-M50f	M40 x 1,5	M50 x 1,5
RCXX/M50m-M50f	M50 x 1,5	M50 x 1,5
RCXX/M50m-M63f	M50 x 1,5	M63 x 1,5
RCXX/M63m-M63f	M63 x 1,5	M63 x 1,5
RCXX/M63m-M75f	M63 x 1,5	M75 x 1,5
RCXX/M75m-M75f	M75 x 1,5	M75 x 1,5
RCXX/M75m-M90f	M75 x 1,5	M90 x 1,5
RCXX/M90m-M90f	M90 x 1,5	M90 x 1,5
RCXX/M90m-M110f	M90 x 1,5	M110 x 1,5
RCXX/M110m-M110f	M110 x 1,5	M110 x 1,5
RCXX/N14m-N14f	NPT 1/4"	NPT 1/4"
RCXX/N14m-N38f	NPT 1/4"	NPT 3/8"
RCXX/N38m-N38f	NPT 3/8"	NPT 3/8"
RCXX/N38m-N12f	NPT 3/8"	NPT 1/2"
RCXX/N12m-N12f	NPT 1/2"	NPT 1/2"
RCXX/N12m-N34f	NPT 1/2"	NPT 3/4"
RCXX/N34m-N34f	NPT 3/4"	NPT 3/4"
RCXX/N34m-N100f	NPT 3/4"	NPT 1"
RCXX/N100m-N100f	NPT 1"	NPT 1"
RCXX/N100m-N114f	NPT 1"	NPT 1 1/4"
RCXX/N114m-N114f	NPT 1 1/4"	NPT 1 1/4"
RCXX/N114m-N112f	NPT 1 1/4"	NPT 1 1/2"
RCXX/N112m-N112f	NPT 1 1/2"	NPT 1 1/2"
RCXX/N112m-N200f	NPT 1 1/2"	NPT 2"
RCXX/N200m-N200f	NPT 2"	NPT 2"
RCXX/N200m-N212f	NPT 2"	NPT 2 1/2"
RCXX/N212m-N212f	NPT 2 1/2"	NPT 2 1/2"
RCXX/N212m-N300f	NPT 2 1/2"	NPT 3"
RCXX/N300m-N300f	NPT 3"	NPT 3"
RCXX/N300m-N400f	NPT 3"	NPT 4"
RCXX/N400m-N 400f	NPT 4"	NPT 4"

KOD	AG	IG
RCXX/M16m-M12f	M16 x 1,5	M12 X 1,5
RCXX/M20m-M12f	M20 x 1,5	M12 X 1,5
RCXX/M20m-M16f	M20 x 1,5	M16 X 1,5
RCXX/M25m-M16f	M25 x 1,5	M16 X 1,5
RCXX/M25m-M20f	M25 x 1,5	M20 X 1,5
RCXX/M32m-M20f	M32 x 1,5	M20 X 1,5
RCXX/M32m-M25f	M32 x 1,5	M25X 1,5
RCXX/M40m-M25f	M40 x 1,5	M25X 1,5
RCXX/M40m-M32f	M40 x 1,5	M32 X 1,5
RCXX/M50m-M32f	M50 x 1,5	M32 X 1,5
RCXX/M50m-M40f	M50 x 1,5	M40 X 1,5
RCXX/M63m-M40f	M63 x 1,5	M40 X 1,5
RCXX/M63m-M50f	M63 x 1,5	M50 X 1,5
RCXX/M75m-M50f	M75 x 1,5	M50 X 1,5
RCXX/M75m-M63f	M75 x 1,5	M63X 1,5
RCXX/M90m-M63f	M90 x 1,5	M63X 1,5
RCXX/M90m-M75f	M90 x 1,5	M75 X 1,5
RCXX/M110m-M75f	M110 x 1,5	M75 X 1,5
RCXX/M110m-M90f	M110 x 1,5	M90 X 1,5
RCXX/N38m-N14f	NPT 3/8"	NPT 1/4"
RCXX/N12m-N14f	NPT 1/2"	NPT 1/4"
RCXX/N12m-N38f	NPT 1/2"	NPT 3/8"
RCXX/N34m-N38f	NPT 3/4"	NPT 3/8"
RCXX/N34m-N12f	NPT 3/4"	NPT 1/2"
RCXX/N100m-N12f	NPT 1"	NPT 1/2"
RCXX/N100m-N34f	NPT 1"	NPT 3/4"
RCXX/N114m-N12f	NPT 1 1/4"	NPT 1/2"
RCXX/N114m-N34f	NPT 1 1/4"	NPT 3/4"
RCXX/N114m-N100f	NPT 1 1/4"	NPT 1"
RCXX/N112m-N12f	NPT 1 1/2"	NPT 1/2"
RCXX/N112m-N34f	NPT 1 1/2"	NPT 3/4"
RCXX/N112m-N100f	NPT 1 1/2"	NPT 1"
RCXX/N112m-N114f	NPT 1 1/2"	NPT 1 1/4"
RCXX/N200m-N114f	NPT 2"	NPT 1 1/4"
RCXX/N200m-N112f	NPT 2"	NPT 1 1/2"
RCXX/N212m-N112f	NPT 2 1/2"	NPT 1 1/2"
RCXX/N212m-N200f	NPT 2 1/2"	NPT 2"
RCXX/N300m-N200f	NPT 3"	NPT 2"
RCXX/N300m-N212f	NPT 3"	NPT 2 1/2"
RCXX/N400m-N212f	NPT 4"	NPT 2 1/2"
RCXX/N400m-N300f	NPT 4"	NPT 3"

KOD	AG (M)	IG (F)
APXX/M16m-N14f	M16 x 1,5	NPT 1/4"
APXX/M20m-N14f	M20 x 1,5	NPT 1/4"
APXX/M25m-N12f	M25 x 1,5	NPT 1/2"
APXX/M32m-N12f	M32 x 1,5	NPT 1/2"
APXX/M32m-N34f	M32 x 1,5	NPT 3/4"
APXX/M40m-N34f	M40 x 1,5	NPT 3/4"
APXX/M40m-N100f	M40 x 1,5	NPT 1"
APXX/M50m-N100f	M50 x 1,5	NPT 1"
APXX/M50m-N114f	M50 x 1,5	NPT 1 1/4"
APXX/M63m-N114f	M63 x 1,5	NPT 1 1/4"
APXX/M63m-N112f	M63 x 1,5	NPT 1 1/2"
APXX/M75m-N112f	M75 x 1,5	NPT 1 1/2"
APXX/M75m-N200f	M75 x 1,5	NPT 2"
APXX/M90m-N200f	M90 x 1,5	NPT 2"
APXX/M90m-N212f	M90 x 1,5	NPT 2 1/2"
APXX/M110m-N212f	M110 x 1,5	NPT 2 1/2"
APXX/M110m-N300f	M110 x 1,5	NPT 3"
APXX/N38m-M12f	NPT 3/8"	M12 x 1,5
APXX/N12m-M12f	NPT 1/2"	M12 x 1,5
APXX/N12m-M16f	NPT 1/2"	M16 x 1,5
APXX/N34m-M16f	NPT 3/4"	M16 x 1,5
APXX/N34m-M20f	NPT 3/4"	M20 x 1,5
APXX/N100m-M20f	NPT 1"	M20 x 1,5
APXX/N100m-M25f	NPT 1"	M25 x 1,5
APXX/N114m-M25f	NPT 1 1/4"	M25 x 1,5
APXX/N114m-M32f	NPT 1 1/4"	M32 x 1,5
APXX/N112m-M32f	NPT 1 1/2"	M32 x 1,5
APXX/N112m-M40f	NPT 1 1/2"	M40 x 1,5
APXX/N200m-M40f	NPT 2"	M40 x 1,5
APXX/N200m-M50f	NPT 2"	M50 x 1,5
APXX/N212m-M50f	NPT 2 1/2"	M50 x 1,5
APXX/N212m-M63f	NPT 2 1/2"	M63 x 1,5
APXX/N300m-M63f	NPT 3"	M63 x 1,5
APXX/N300m-M75f	NPT 3"	M75 x 1,5
APXX/N400m-M75f	NPT 4"	M75 x 1,5
APXX/N400m-M90f	NPT 4"	M90 x 1,5



**E1W TİP ZIRHLI PİRİNÇ KABLO RAKORLARI BS6121**

Anma Ölçüsü	Kod	C Standart Dış		D Dış Boyu mm.	A Kablo Çapı		B Kablo Çapı		Birim Fiyatı €
		Metrik	NPT		min.	max.	min.	max.	
16	E1W-M16	M16 x 1,5	1/2"	15	3.1	8.6	6.1	13.2	10,48
20ss	E1W-M20ss	M20 x 1,5	1/2"	15	3.1	8.6	6.1	13.2	10,48
20s	E1W-M20s	M20 x 1,5	1/2"	15	8.8	11.7	11.8	16	10,48
20	E1W-M20L	M20 x 1,5	1/2"	15	11.4	14	14	20	14,02
25s	E1W-M25s	M25 x 1,5	3/4"	15	13	16	18	24	21,20
25	E1W-M25L	M25 x 1,5	3/4"	15	17	20	20	27	21,20
32s	E1W-M32s	M32 x 1,5	1"	15	20	23	24.5	31	30,00
32	E1W-M32L	M32 x 1,5	1"	15	24	26	26	33	30,00
40s	E1W-M40s	M40 x 1,5	1 1/4"	15	26	29	30.4	36	43,00
40	E1W-M40L	M40 x 1,5	1 1/4"	15	29.5	32	33	40	43,00
50s	E1W-M50s	M50 x 1,5	1 1/2"	15	33	38	40	46	53,86
50	E1W-M50L	M50 x 1,5	2"	20	38	44	44	52.6	70,96
63s	E1W-M63s	M63 x 1,5	2"	20	44	50	50	59	82,42
63	E1W-M63L	M63 x 1,5	2 1/2"	20	50	56	56	66	99,39
75s	E1W-M75s	M75 x 1,5	2 1/2"	20	56	62	63.5	71	149,00
75	E1W-M75L	M75 x 1,5	3"	20	62	68	69	78	181,00
90	E1W-M90L	M90 x 1,5	3 1/2"	20	65	80	84	96	308,00
100	E1W-M100L	M100 x 1,5	4"	20	82	90	84	102	429,00

**CW TİP ZIRHLI PİRİNÇ KABLO RAKORLARI BS6121**

Anma Ölçüsü	Kod	C Standart Dış		D Dış Boyu mm.	A Kablo Çapı Max./mm.	B Kablo Çapı		Birim Fiyatı €
		Metrik	NPT			min.	max.	
16	CW-M16	M16 x 1,5	1/2"	10	8.6	6.1	13.2	10,27
20ss	CW-M20ss	M20ss x 1,5	1/2"	10	8.6	6.1	13.2	10,27
20s	CW-M20s	M20s x 1,5	1/2"	10	11	11	15	10,27
20	CW-M 20L	M20 x 1,5	1/2"	10	14	15	20	12,00
25s	CW-M 25S	M25s x 1,5	3/4"	10	16	18	24	18,11
25	CW-M 25L	M25 x 1,5	3/4"	12	19	20	27	18,11
32	CW-M 32L	M32 x 1,5	1"	12	25	26	33	26,80
40s	CW-M 40S	M40s x 1,5	1-1/4"	13	27	31,5	39,5	46,82
40	CW-M 40L	M40 x 1,5	1-1/4"	15	32	32	40	46,82
50s	CW-M 50s	M50s x 1,5	1-1/2"	15	38	38	46	50,74
50	CW-M 50L	M50 x 1,5	2"	15	43	44	53	70,22
63s	CW-M 63s	M63s x 1,5	2"	15	50	50	59	94,76
63	CW-M 63L	M63 x 1,5	2-1/2"	15	55	58	65	98,41
75s	CW-M 75s	M75s x 1,5	2-1/2"	16	62	62	71	118,94
75	CW-M 75L	M75 x 1,5	3"	16	68	68	78	143,00
90	CW-M 90L	M90 x 2	3-1/2"	18	80	80	91	Teklif İsteyiniz
100	CW-M 100L	M100s x 2	4"	20	90	86	99	Teklif İsteyiniz

**BWL TİP ZIRHLI PİRİNÇ KABLO RAKORLARI BS6121**

Anma Ölçüsü	Kod	C Standart Dış		D Dış Boyu mm.	A Kablo Çapı Max./mm.	B Kablo Çapı Max./mm.	Birim Fiyatı €
		Metrik	NPT				
20s	BWL-M20s	M20 x 1,5s	1/2"	10	11,5	15,5	8,22
20	BWL-M 20L	M20 x 1,5	1/2"	10	14	20,5	9,29
25s	BWL-M 25s	M25s x 1,5	3/4"	10	18	24	11,60
25	BWL-M 25L	M25 x 1,5	3/4"	10	20	27	12,24
32s	BWL-M 32s	M32s x 1,5	1"	10	26	33,5	16,26
32	BWL-M 32L	M32 x 1,5	1"	10	26	34	16,26
40	BWL-M 40L	M40 x 1,5	1-1/4"	13	32	40	23,32
50s	BWL-M 50s	M50 x 1,5s	1-1/2"	13	38	46	25,73
50	BWL-M 50L	M50 x 1,5	2"	13	44	52	29,46
63s	BWL-M 63s	M63 x 1,5s	2"	14	50	59	41,91
63	BWL-M 63L	M63 x 1,5	2-1/2"	14	56	65,3	64,29
75s	BWL-M 75s	M75 x 1,5s	2-1/2"	15	62	71	Teklif İsteyiniz
75	BWL-M 75L	M75 x 1,5	3"	15	68	78	Teklif İsteyiniz
90	BWL-M 90L	M90 x 2	3-1/2"	18	80	91	Teklif İsteyiniz



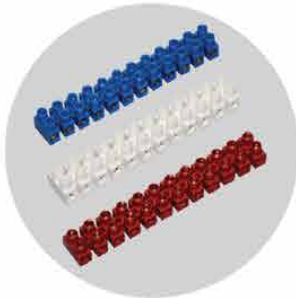
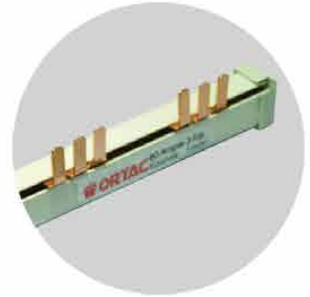
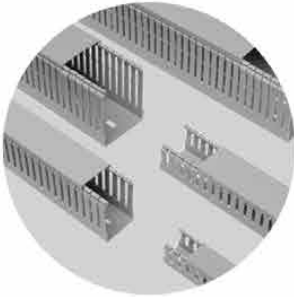

**YANMAZ SIRA KLEMENSLER (Beyaz / Kahverengi)**

Kod	Boy	Kablo Kesit mm.	Göz Adedi	Renk	Ambalaj Miktarı	Birim Fiyatı TL
YPLS 00	0 NO	1,5	12	BEYAZ	50	3,61
YPLS 01	1 NO	2,5-4	12	BEYAZ	50	3,86
YPLS 02	2 NO	4-6	12	BEYAZ	50	5,20
YPLS 03	3 NO	6-10	10	BEYAZ	50	6,90
YPLS 04	4 NO	10-16	6	BEYAZ	50	7,36
YPLS 05	5 NO	16-25	6	BEYAZ	50	9,01

**PLASTİK SIRA KLEMENSLER (Mavi / Siyah)**

PLS 01	1 NO	2,5-4	12	MAVİ	50	3,74
PLS 02	2 NO	4-6	12	MAVİ	50	4,97
PLS 03	3 NO	6-10	10	MAVİ	50	6,18
PLS 04	4 NO	10-16	6	MAVİ	50	6,52
PLS 05	5 NO	16-25	6	MAVİ	50	8,08

**SOKET KLEMENSLER**

SK 102	1 NO	2,5-4	1 - 2	BEYAZ	100	3,96
SK 103	1 NO	2,5-4	1 - 3	BEYAZ	100	6,58
SK 104	1 NO	2,5-4	1 - 4	BEYAZ	100	8,49
SK 120	1 NO	2,5-4	12	BEYAZ	30	22,30

**KAPAKLI 3'LÜ SOKET KLEMENS**

SK 103K	1 NO	2,5-4	1 - 2	SIYAH BEYAZ	100	9,76
---------	------	-------	-------	-------------	-----	------

**PORSELEN KLEMENSLER**

PK 12	1 NO 2	2,5	2	KREM	150	1,24
PK 13	1 NO 3	4,6	3	KREM	100	1,79
PK 22	2 NO 2	4,6	2	KREM	100	1,79
PK 23	2 NO 3	6,4	3	KREM	50	2,48
PK 32	3 NO 2	6,1	2	KREM	50	2,48
PK 33	3 NO 3	6,1	3	KREM	35	3,46

**GEÇMELİ BUAT KLEMENLSERİ**

Kod	Şeffaf Kod	Renk	Kutup Sayısı	Kablo Kesit	Ambalaj Miktarı	Birim Fiyatı TL
PC-252	PCS-252	2 (KIRMIZI)	2	2,5mm <sup>2</sup>	500	0,53
PC-253	PCS-253	3 (ORANJ)	3	2,5mm <sup>2</sup>	500	0,59
PC-254	PCS-254	4 (SARI)	4	2,5mm <sup>2</sup>	500	0,70
PC-255	PCS-255	5 (GRİ)	5	2,5mm <sup>2</sup>	500	0,79
PC-258	PCS-258	8 (SIYAH)	8	2,5mm <sup>2</sup>	500	1,85



**STANDART PANO İÇİ DELİKLİ KABLO KANALLARI (2 mt.) RAL 7030 GRİ**

ORTAC

Kod	Ölçü mm.	Slot Aralığı mm.	Ambalaj Miktarı / mt.	Birim Fiyatı TL / mt.
ODK2540	25x40	4/6/4	128	9,07
ODK2560	25x60	4/6/4	96	14,61
ODK2580	25x80	4/6/4	64	18,13
ODK4040	40x40	4/6/4	70	12,09
ODK4060	40x60	4/6/4	60	17,13
ODK4080	40x80	4/6/4	40	23,17
ODK4010	40x100	5/8/5	40	29,21
ODK6040	60x40	4/6/4	50	17,63
ODK6060	60x60	4/6/4	48	21,16
ODK6080	60x80	4/6/4	32	27,20
ODK6010	60x100	5/8/5	32	34,25
ODK8060	80x60	4/6/4	28	27,20
ODK8080	80x80	4/6/4	24	33,24
ODK8010	80x100	5/8/5	24	42,31
ODK1060	100x60	4/6/4	20	33,24
ODK1080	100x80	4/6/4	20	40,30
ODK1010	100x100	5/8/5	16	65,98
ODK1260	120x60	4/6/4	20	43,32
ODK1280	120x80	4/6/4	16	56,41



**KAPALI TİP KABLO KANALI (Beyaz)**

Kod	Genişlik (mm)	Yükseklik (mm)	Ambalaj Miktarı / mt.	Birim Fiyatı TL / mt.
OKK 1212	12	12	320	1,48
OKK 1510	15	10	300	1,69
OKK 2010	20	10	240	2,06
OKK 1616	16	16	180	1,98
OKK 2516	25	16	154	3,11
OKK 2525	25	25	96	3,93
OKK 4016	40	16	84	5,79
OKK 4025	40	25	80	5,50
OKK 4040	40	40	72	6,58
OKK 6040	60	40	48	10,18
OKK 6060	60	60	40	13,23
OKK 8040	80	40	36	14,55
OKK 8060	80	60	32	17,96
OKK 10040	100	40	28	16,77
OKK 10060	100	60	24	20,43

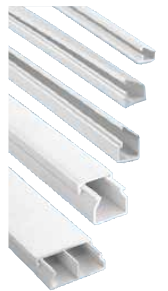

**YAPIŞKANLI KAPALI TİP KABLO KANALI (Beyaz)**

Kod	Genişlik (mm)	Yükseklik (mm)	Ambalaj Miktarı / mt.	Birim Fiyatı TL / mt.
OKKY 1212	12	12	320	1,78
OKKY 2010	20	10	240	2,59
OKKY 1616	16	16	180	2,36
OKKY 2516	25	16	154	3,80
OKKY 2525	25	25	96	4,61
OKKY 4016	40	16	84	6,92
OKKY 4025	40	25	80	6,87
OKKY 4040	40	40	72	7,12

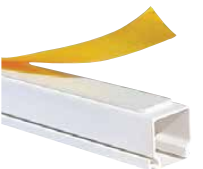

## MÜŞTEREK BARA SİSTEMLERİ



Kod	Cinsi	Kalınlık mm.	Modül	Kutu Adedi	Birim Fiyatı TL
<b>Trifaze Bara Sistemleri</b>					
TMB 10A	TRİFAZE	1	53 CM / 10	25	35,70
TMB 10B	TRİFAZE	1,5	53 CM / 10	25	53,55
TMB 110A	TRİFAZE	1	106 CM / 20	10	78,54
TMB 110B	TRİFAZE	1,5	106 CM / 20	10	117,81
<b>Monofaze Bara Sistemleri</b>					
MMB 10A	MONOFAZE	1	53 CM / 30	50	13,70
MMB 10B	MONOFAZE	1,5	53 CM / 30	50	21,00
MMB 110A	MONOFAZE	1	100 CM / 56	25	27,00
MMB 110B	MONOFAZE	1,5	100 CM / 56	25	42,00
<b>Nötr Topraklama Bara Sistemleri</b>					
NTK 31A	NÖTR TOPRAKLAMA	1,5	15x1mt.31 Vida	25	35,70
NTK 62A	NÖTR TOPRAKLAMA	1,5	15x1mt.61 Vida	25	40,00
BM 01	BARA MESNEDİ	-	-	100	1,21

## MONTAJ RAYLARI



Kod	Uzunluk	Genişlik/Derinlik mm.	Ürün Özelliği	Kutu İçeriği mt.	Birim Fiyatı TL
ODSR02	1 mt	35*7,5	Deliksiz Montaj Rayı	50	4,86
ODSR03	2 mt.	35*7,5	Deliksiz Montaj Rayı	100	9,70
ODSR04	3 mt.	35*7,5	Deliksiz Montaj Rayı	25	14,57
ODSR06	1 mt.	35*7,5	Delikli Montaj Rayı	50	5,23
ODSR07	2 mt.	35*7,5	Delikli Montaj Rayı	100	10,47
ODSR08	3 mt.	35*7,5	Delikli Montaj Rayı	25	15,67
RTS	-	Ray Taşıyıcı Ayak - Sac		50	1,96
RTA	-	Ray Taşıyıcı Ayak - Alüminyum		50	2,80

## KABLO TOPLAMA ÇORAPLARI



Kod	Minimum Tutma Çapı mm.	Maksimum Tutma Çapı mm.	Ambalaj Miktarı mt.	Birim Fiyatı €
OKC06	3	9	100	0,31
OKC08	5	16	100	0,43
OKC10	7	19	100	0,48
OKC12	12	24	50	0,60
OKC15	10	27	50	0,65
OKC20	14	30	50	0,86
OKC25	18	35	25	1,08
OKC30	20	50	25	1,45
OKC50	40	80	25	2,51

## HELEZON PANO SPİRALLERİ

Renkleri Mevcuttur



Kod	Boy	Uzunluk cm.	Ambalaj Miktarı	Birim Fiyatı TL
HPS 0	0 NO (4-6)	50	100	0,28
HPS 1	1 NO (6-8)	50	100	0,31
HPS 2	2 NO (8-10)	50	100	0,39
HPS 3	3 NO (11-13)	50	100	0,71
HPS 4	4 NO (14-16)	50	50	1,30
HPS 5	5 NO (16-18)	50	50	1,71

## HELEZON PANO SPİRALLERİ (Rulo Tip)

Renkleri Mevcuttur



Kod	Boy	Uzunluk cm.	Ambalaj Miktarı	Birim Fiyatı TL
HPSR 0	0 NO (4-6)	50	100	0,55
HPSR 1	1 NO (6-8)	50	100	0,62
HPSR 2	2 NO (8-10)	50	100	0,78
HPSR 3	3 NO (11-13)	50	100	1,42
HPSR 4	4 NO (14-16)	50	100	2,60
HPSR 5	5 NO (16-18)	50	50	3,43

**GAMAK TİPİ ORJİNAL MOTOR KLEMENSLERİ**

Kod	Boy	Boy mm.	En mm.	Vida	Renk	Kutu Adedi	Birim Fiyatı TL
MK 01	56 - 63	40	25	M 4	SİYAH	50	2,56
MK 02	71 - 80 - 90 - 100	50	30	M 4		50	2,98
MK 03	132	60	37	M 5		50	3,85
MK 04	160 - 180	72	44	M 6		40	5,60
MK 05	225 - 250	91	56	M 8		15	10,42
MK 06	280	115	70	M 10		6	18,43

**GAMAK TİPİ ORJİNAL CAM ELYAFLI MOTOR KLEMENSLERİ**

Kod	Boy	Boy mm.	En mm.	Vida	Renk	Kutu Adedi	Birim Fiyatı TL
MKE 01	56 - 63	40	25	M 4	KAHVE RENGİ	50	2,90
MKE 02	71 - 80 - 90 - 100	50	30	M 4		50	3,45
MKE 03	132	60	37	M 5		50	4,38
MKE 04	160 - 180	72	44	M 6		40	6,42
MKE 05	225 - 250	91	56	M 8		15	11,96
MKE 06	280	115	70	M 10		6	21,17

**GAMAK TİPİ ORJİNAL MOTOR PERVANELERİ**

Kod	Boy	Bağ Adedi	Renk	Birim Fiyatı TL
ORT 02	63	10	SİYAH	2,61
ORT 03	71	10		3,12
ORT 04	80	10		3,50
ORT 05	90	10		4,82
ORT 06	100 - 112	10		5,37
ORT 07	132	5		10,16
ORT 08	160	5		13,40
ORT 09	180	5		15,64
ORT 10	200 - 225 - 57	5		23,83
ORT 11	200 - 225 - 62	5		23,83

**KLEMENS KUTULARI**

Kod	Cinsi	Boy	Kutu Adedi	Birim Fiyatı TL
PMK 01	0 NO	56 - 63	10	4,32
PMK 02	1 NO	71 - 80 - 90	10	5,05
PMK 03	2 NO	100 - 112	10	7,31
PMK 04	3 NO	132	5	13,63
PMK 05	4 NO	160 - 180	5	27,00

**GAMAK TİPİ MOTOR TASLARI**

Kod	Boy	Birim Fiyatı TL
GT 01	71	
GT 02	80	
GT 03	90	
GT 04	100	
GT 05	112	
GT 06	132	
GT 07	160	
GT 08	180	
GT 09	200	
GT 10	225	
GT 11	250	
GT 12	280	
GT 13	315	
GT 14	355	

**WAT MOTOR PERVANELERİ**

Kod	Boy	Birim Fiyatı TL
WQS63	63	12,80
WQS71	71	13,45
WQS80	80	14,33
WQS-QU90	90	15,63
WQS-QU100	100	16,93
WQS-QU112	112	23,15
WQS132	132	27,00
WQU132M	132	30,00
WQU160	160	46,20
WQU180	180	46,20
WQU200/2-4-8	200	77,00
WQU225/2	225	77,00
WQU250	250	87,00



**AG MESNET İZOLATÖRLER**

	Kod	Cinsi	Kutu Adedi	Birim Fiyatı TL
<b>MİNİ İZOLATÖR</b>				
	BMI-M5 2C	M5 Mini İzolatör	250	1,52
	BMI-M5 1C+1S	M5 Mini İzolatör	250	1,85
	BMI-M5 2S	M5 Mini İzolatör	250	2,38
<b>ORTA BOY KONİK İZOLATÖR</b>				
	OBKI-M6 2C	M6 Orta Boy Konik İzolatör	100	2,40
	OBKI-M6 1C+1S	M6 Orta Boy Konik İzolatör	100	2,84
	OBKI-M6 2S	M6 Orta Boy Konik İzolatör	100	3,22
<b>ORTA BOY FIÇI İZOLATÖR</b>				
	OBMI-M6 2C	M6 Orta Boy Fıçı İzolatör	50	2,53
	OBMI-M6 1C+2S	M6 Orta Boy Fıçı İzolatör	50	3,01
	OBMI-M6 2S	M6 Orta Boy Fıçı İzolatör	50	3,37
	OBMI-M8 2C	M8 Orta Boy Fıçı İzolatör	50	3,14
	OBMI-M8 1C+2S	M8 Orta Boy Fıçı İzolatör	50	3,46
	OBMI-M8 2S	M8 Orta Boy Fıçı İzolatör	50	3,62
<b>40MM BÜYÜK BOY FIÇI İZOLATÖR (M8-M10)</b>				
	BBMI-M8 2C	M8 Büyük Boy Fıçı İzolatör	40	4,51
	BBMI-M8 1C+1S	M8 Büyük Boy Fıçı İzolatör	40	5,11
	BBMI-M8 2S	M8 Büyük Boy Fıçı İzolatör	40	5,49
	BBMI-M10 2C	M10 Büyük Boy Fıçı İzolatör	40	6,00
	BBMI-M10 1C+1S	M10 Büyük Boy Fıçı İzolatör	40	6,11
	BBMI-M10 2S	M10 Büyük Boy Fıçı İzolatör	40	6,22
<b>50MM BÜYÜK BOY FIÇI İZOLATÖR (M10)</b>				
	BMI-M 10 2C	M10 Büyük Boy Fıçı İzolatör	20	8,76
	BMI-M 10 1C+1S	M10 Büyük Boy Fıçı İzolatör	20	8,87
	BMI-M 10 2S	M10 Büyük Boy Fıçı İzolatör	20	9,74
<b>3X1 F TARAK İZOLATÖR</b>				
	3X1F	Tarak İzolatörü Kısa Tip	20	
	3X1F-U	Tarak İzolatörü Uzun Tip	40	7,19
				9,86
<b>3X2 F TARAK İZOLATÖR</b>				
	3X2F	Tarak İzolatörü	40	11,00
	3X1F+N	Tarak İzolatörü	40	11,60
	3X2F+N	Tarak İzolatörü	8	15,05
	3X1FS	Tarak İzolatörü (Siyah)	30	8,80
	3X2FS	Tarak İzolatörü (Siyah)	50	14,88
<b>1-500 İZOLATÖR</b>				
	1N 50010	M10 1n-500 Mesnet İzolatör	12	10,56
	1N 500102	M12 1n-500 Mesnet İzolatör	12	11,88
<b>1NK İZOLATÖR</b>				
	1 NK 50016	M16 1nk İzolatör	12	16,96
	BMS M8	M8 Bara Tutucu Serfil	50	4,14



2C : İki taraflı civatalı  
 1C + 1S : Bir taraflı civatalı bir taraflı kör somunlu  
 2S : İki taraflı kör somunlu

**ISIYLA DARALAN MAKARONLAR**

Kod	Ölçü mm.	Renk	Ambalaj Miktarı	Birim Fiyatı USD
IDM 1,5	1,5 / 0,75	SİYAH	200	0.094
IDM 1,6	1,6 / 1		200	0.094
IDM 2	2 / 1		200	0.098
IDM 2,4	2,4 / 1,5		200	0.101
IDM 2,5	2,5 / 1,25		200	0.108
IDM 3	3 / 1,5		200	0.127
IDM 3,2	3,2 / 1,75		200	0.127
IDM 3,5	3,5 / 1,75		100	0.132
IDM 4	4 / 2		100	0.158
IDM 4,5	4,5 / 2,25		100	0.166
IDM 4,8	4,8 / 2,6		100	0.166
IDM 5	5 / 2,50		100	0.187
IDM 6	6 / 3		100	0.216
IDM 6,4	6,4 / 3,5		100	0.216
IDM 7	7 / 3,5		100	0.259
IDM 8	8 / 4		100	0.266
IDM 10	10 / 5		100	0.288
IDM 9,5	9,5 / 5		100	0.274
IDM 12,7	12,7 / 6,5		100	0.331
IDM 13	13 / 6,5		100	0.360
IDM 16	16 / 8	100	0.576	
IDM 18	18 / 9	100	0.749	
IDM 19,1	19,1 / 10	100	0.756	
IDM 20	20 / 10	50	0.936	
IDM 22	22 / 11	50	1.152	
IDM 25,4	25,4 / 12	50	1.195	
IDM 30	30 / 15	50	1.872	
IDM 32	32 / 16,5	50	1.872	
IDM 35	35 / 17,5	25	2.376	
IDM 38	38 / 20	50	2.520	
IDM 40	40 / 20	25	2.592	
IDM 51	51 / 25	25	3.600	
IDM 60	60 / 30	25	5.040	
IDM 70	70 / 35	25	6.624	
IDM 80	80 / 40	25	7.632	
IDM 102	102 / 51	25	9.360	
IDM 120	120 / 60	15	13.680	

**ISIYLA DARALAN MAKARONLAR (Renkli)**

Kod	Ölçü mm.	Renk	Ambalaj Miktarı	Birim Fiyatı USD
IDMR 1,6 ...	2/1	ŞEFFAF BEYAZ KIRMIZI MAVİ YEŞİL GRİ	200	0.101
IDMR 2,4 ...	3/1,5		200	0.158
IDMR 3,2...	3,5/17,5		200	0.187
IDMR 4,8...	5,2/2,6		100	0.216
IDMR 6,4...	7/3,5		100	0.274
IDMR 9,5...	10/5		100	0.346
IDMR 12,7...	13/6,5		100	0.461
IDMR 16...	16,5/8		100	0.821
IDMR 19,1...	20,5/10		100	1.325
IDMR 25,4...	25,6/12		100	1.800
IDMR 32...	33/16,5		50	2.448
IDMR38...	40/20		50	3.816
IDMR51...	52,5/25		50	4.176
IDMR76...	80/40		25	8.208
IDMR102...	105/51		25	10.800



### PASLANMAZ ELİK KABLO BAęLARI- 304

Kod	Boy	En	Renk	Azami Sıkma apı	Aılma Mukavemet	Ambalaj Miktarı	304 Kalite B.Fiyat Usd
ST-46150S	150	4.6	METAL	44	55	100	0.236
ST-46200S	200		METAL	61	55	100	0.283
ST-46250S	250		METAL	81	55	100	0.303
ST-46300S	300		METAL	93	55	100	0.318
ST-46360S	360		METAL	112	55	100	0.384
ST-46500S	500		METAL	145	55	100	0.402
ST-46520S	520		METAL	163	55	100	0.425
ST-46680M	680		METAL	214	55	100	0.586
ST-46840M	840	METAL	65	55	100	0.711	
ST-79200S	200	7.9	METAL	62	120	100	0.377
ST-79300S	300		METAL	65	120	100	0.425
ST-79360S	360		METAL	112	120	100	0.474
ST-79500S	500		METAL	145	120	100	0.607
ST-79520S	520		METAL	163	120	100	0.628
ST-79680S	680		METAL	214	120	100	0.725
ST-79840S	840		METAL	265	120	100	0.907



### KAPLAMALI PASLANMAZ ELİK KABLO BAęLARI- 304

Kod	Boy	En	Renk	Azami Sıkma apı	Aılma Mukavemet	Ambalaj Miktarı	304 Kalite B.Fiyat Usd
STP- 46150S	150	4.6	SİYAH	44	55	100	0.293
STP-46200S	200		SİYAH	61	55	100	0.335
STP-46250S	250		SİYAH	81	55	100	0.356
STP-46300S	300		SİYAH	93	55	100	0.391
STP-46360S	360		SİYAH	112	55	100	0.419
STP-46520S	520		SİYAH	163	55	100	0.488
STP-46680M	680		SİYAH	214	55	100	0.711
STP-46840M	840		SİYAH	65	55	100	1.004
STP-79200S	200	7.9	SİYAH	62	120	100	0.419
STP-79300S	300		SİYAH	65	120	100	0.488
STP-79360S	360		SİYAH	112	120	100	0.544
STP-79520S	520		SİYAH	163	120	100	0.725
STP-79680S	680		SİYAH	214	120	100	0.879
STP-79840S	840		SİYAH	265	120	100	1.269



- Malzeme : 304-316 Paslanmaz elik  
 Kaplama Tipleri : Akrilik - Pvc  
 alıřma Sıcaklık : -80+500  
 Alev Yürümeme : UL94V-2  
 Su Emilimi : 0%  
 Uygulama Alanları : Tersane,Marin,Demirelik,Petro Kimya,Rüzgar ve Güneř Santralleri  
 Özellik : Kendiięinden kilitlebilir kafa tasarımı sayesinde montaj kolaylıęı  
 Kablo baęı gövdesi boyunca herhangi bir noktadan kilitlelenebilir.  
 Pürüzsüz yüzeyi ve yuvarlatılmıř uçları ile kabloyu ve alıřanı korur.  
 İ ve dıř mekanda uygulanabilir.  
 řebeke kablolarında en üst düzey desteęi saęlar  
 Ultraviyole dayanıklıdır.





**ORTAC**<sup>®</sup>

Kablo Baęlantı Elemanları



**tacflex**

**SPIRAL BORU & AKSESUARLARI**

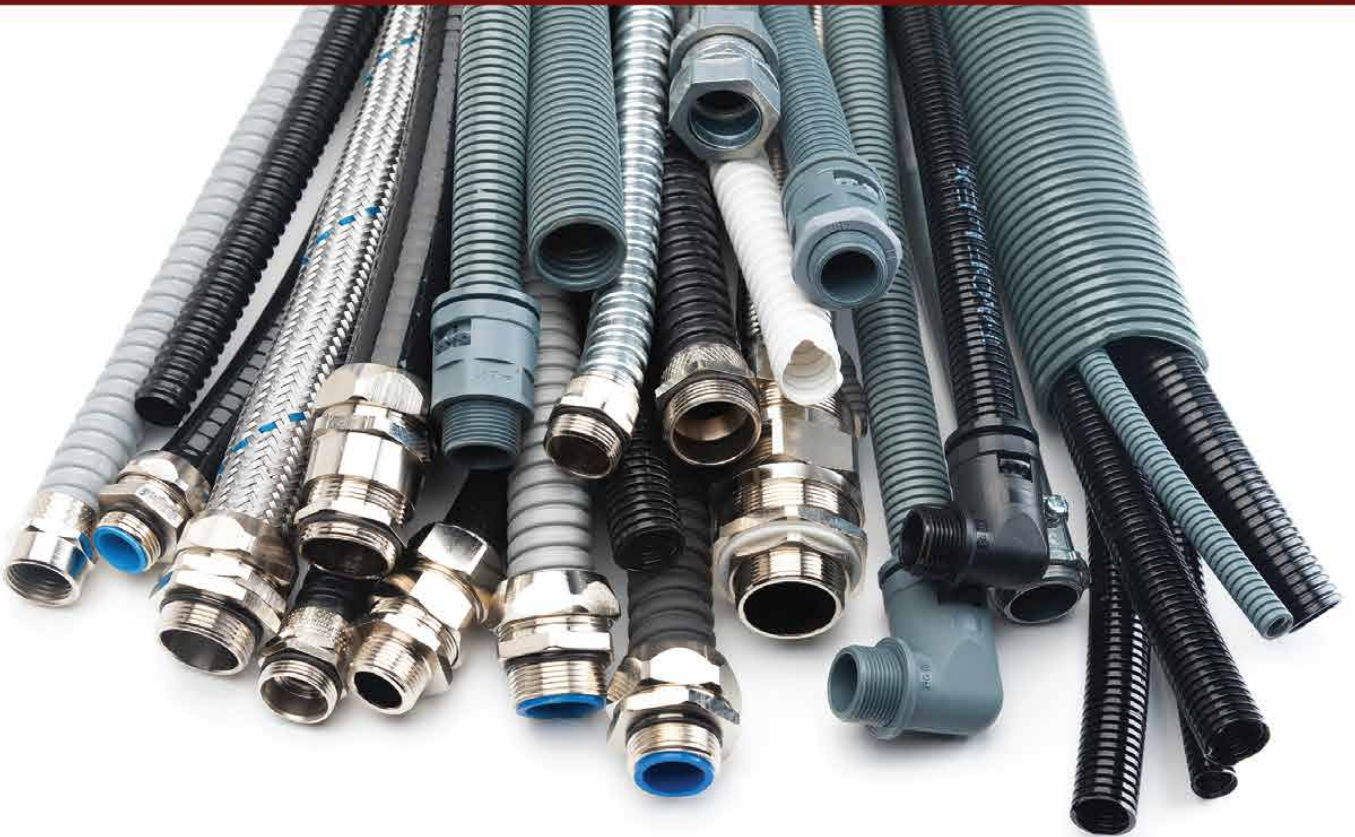

**KABLO KORUMA, TAŞIMA & SONLANDIRMA SİSTEMLERİ**

## POLYAMİD SİRİRAL BORULAR



Anma Çapı	Gri Kod	Siyah Kod	İç Çap mm.	Dış Çap mm.	Ambalaj Miktarı	Birim Fiyatı €
7	OGPA 7	OSPA 7	7	10	100	0,39
8,5	OGPA 8,5	OSPA 8,5	8,5	12	100	0,43
9	OGPA 9	OSPA 9	10	13	100	0,50
11	OGPA 11	OSPA 11	12	15,8	50	0,69
13,5	OGPA 13,5	OSPA 13,5	14,2	18,4	50	0,77
16	OGPA 16	OSPA 16	16,5	21,2	50	0,97
21	OGPA 21	OSPA 21	23,5	28,4	50	1,37
29	OGPA 29	OSPA 29	29	34,5	25	1,80
36	OGPA 36	OSPA 36	36	42,5	25	2,27
48	OGPA 48	OSPA 48	48	54,5	25	3,56

## POLİPROPİLEN SİRİRAL BORULAR



7	OGPP 7	OSPP 7	7	10	100	0,22
8,5	OGPP 8,5	OSPP 8,5	8,5	12	100	0,25
9	OGPP 9	OSPP 9	10	13	100	0,29
11	OGPP 11	OSPP 11	12	15,8	50	0,31
13,5	OGPP 13,5	OSPP 13,5	14,2	18,4	50	0,41
16	OGPP 16	OSPP 16	16,5	21,2	50	0,45
21	OGPP 21	OSPP 21	23,5	28,4	50	0,63
29	OGPP 29	OSPP 29	29	34,5	25	0,76
36	OGPP 36	OSPP 36	36	42,5	25	0,99
48	OGPP 48	OSPP 48	48	54,5	25	1,61

## POLYAMİD YARIKLI SİRİRAL BORULAR



7	OGPAY 7	OSPAY 7	7	10	100	0,48
8,5	OGPAY 8,5	OSPAY 8,5	8,5	12	100	0,54
9	OGPAY 9	OSPAY 9	10	13	100	0,63
11	OGPAY 11	OSPAY 11	12	15,8	50	0,90
13,5	OGPAY 13,5	OSPAY 13,5	14,2	18,4	50	0,96
16	OGPAY 16	OSPAY 16	16,5	21,2	50	1,21
21	OGPAY 21	OSPAY 21	23,5	28,4	50	1,71
29	OGPAY 29	OSPAY 29	29	34,5	25	2,25
36	OGPAY 36	OSPAY 36	36	42,5	25	2,84
48	OGPAY 48	OSPAY 48	48	54,5	25	4,67

## POLİPROPİLEN YARIKLI SİRİRAL BORULAR



7	OGPPY 7	OSPPY 7	7	10	100	0,28
8,5	OGPPY 8,5	OSPPY 8,5	8,5	12	100	0,32
9	OGPPY 9	OSPPY 9	10	13	100	0,37
11	OGPPY 11	OSPPY 11	12	15,8	50	0,39
13,5	OGPPY 13,5	OSPPY 13,5	14,2	18,4	50	0,52
16	OGPPY 16	OSPPY 16	16,5	21,2	50	0,56
21	OGPPY 21	OSPPY 21	23,5	28,4	50	0,79
29	OGPPY 29	OSPPY 29	29	34,5	25	0,95
36	OGPPY 36	OSPPY 36	36	42,5	25	1,24
48	OGPPY 48	OSPPY 48	48	54,5	25	2,01

## ÇELİK TEL ÖRGÜLÜ POLYAMİD SİRİRAL BORULAR



7	CTPAG 7	CTPAS 7	7	11	100	2,44
8,5	CTPAG 8,5	CTPAS 8,5	8,5	13	100	2,88
9	CTPAG 9	CTPAS 9	10	14	100	3,17
11	CTPAG 11	CTPAS 11	12	16,8	50	3,97
13,5	CTPAG 13,5	CTPAS 13,5	14,2	19,4	50	4,57
16	CTPAG 16	CTPAS 16	16,5	22,2	50	5,39
21	CTPAG 21	CTPAS 21	23,5	29,4	50	7,34
29	CTPAG 29	CTPAS 29	29	35,5	25	8,99
36	CTPAG 36	CTPAS 36	36	43,5	25	11,16
48	CTPAG 48	CTPAS 48	48	55,5	25	15,53

- İstenilen metraj tek parça halinde üretilebilir
- Paslanmaz tel örgü kaplanabilir



**PG DİŞ GEÇMELİ TİP RAKORLAR**

Gri Kod	Siyah Kod	Spiral Kod	Spiral Ölçü mm.	Kutu Adedi	Birim Fiyatı €
ODG10-PG7	ODB10-PG7	OGPA 7	6,5 x 10	100	0,38
ODG12-PG7	ODB12-PG7	OGPA 8,5	8,5 x 12	75	0,38
ODG13-PG9	ODB13-PG9	OGPA 9	10 x 13	50	0,39
ODG15-PG11	ODB15-PG11	OGPA 11	12 x 15,8	50	0,45
ODG18-PG13,5	ODB18-PG13,5	OGPA 13,5	14,2 x 18,4	75	0,52
ODG21-PG16	ODB21-PG16	OGPA 16	16,5 x 21,2	50	0,65
ODG28-PG21	ODB28-PG21	OGPA 21	23,5 x 28,4	25	1,05
ODG34-PG29	ODB34-PG29	OGPA 29	29 x 34,5	20	1,35
ODG42-PG36	ODB42-PG36	OGPA 36	36 x 42,5	15	1,86
ODG54-PG48	ODB54-PG48	OGPA 48	48 x 54,5	10	2,50

**ÖZEL BOY PG DİŞ GEÇMELİ TİP RAKORLAR**

ODG13-PG7	ODB13-PG7	OGPA 9	10 x 13	50	0,46
ODG13-PG11	ODB13-PG11	OGPA 9	10 x 13	50	0,48
ODG13-PG13,5	ODB13-PG13,5	OGPA 9	10 x 13	50	0,51
ODG15-PG9	ODB15-PG9	OGPA 11	12 x 15,8	50	0,58
ODG15-PG13,5	ODB15-PG13,5	OGPA 11	12 x 15,8	50	0,58
ODG18-PG9	ODB18-PG9	OGPA 13,5	14,2 x 18,4	75	0,67
ODG18-PG11	ODB18-PG11	OGPA 13,5	14,2 x 18,4	75	0,67
ODG21-PG13,5	ODB21-PG13,5	OGPA 16	16,5 x 21,2	50	0,77

**METRİK DİŞ GEÇMELİ TİP RAKORLAR**

Gri Kod	Siyah Kod	Spiral Kod	Spiral Ölçü mm.	Kutu Adedi	Birim Fiyatı €
ODG10-M12	ODB10-M12	OGPA 7	6,5 x 10	100	0,39
ODG12-M12	ODB12-M12	OGPA 8,5	8,5 x 12	75	0,39
ODG13-M16	ODB13-M16	OGPA 9	10 x 13	50	0,43
ODG15-M16	ODB15-M16	OGPA 11	12 x 15,8	50	0,51
ODG18-M20	ODB18-M20	OGPA 13,5	14,2 x 18,4	75	0,58
ODG21-M20	ODB21-M20	OGPA 16	16,5 x 21,2	50	0,76
ODG28-M25	ODB28-M25	OGPA 21	23,5 x 28,4	25	1,22
ODG34-M32	ODB34-M32	OGPA 29	29 x 34,5	20	2,05
ODG42-M40	ODB42-M40	OGPA 36	36 x 42,5	15	2,80
ODG54-M63	ODB54-M63	OGPA 48	48 x 54,5	10	3,70

**ÖZEL BOY METRİK DİŞ GEÇMELİ TİP RAKORLAR**

ODG13-M12	ODB13-M12	OGPA 9	10 x 13	50	0,46
ODG13-M20	ODB13-M20	OGPA 9	10 x 13	50	0,51
ODG18-M16	ODB18-M16	OGPA 13,5	14,2 x 18,4	75	0,58
ODG15-M20	ODB15-M20	OGPA 11	12 x 15,8	50	0,67
ODG21-M25	ODB21-M25	OGPA 16	16,5 x 21,2	50	0,77
ODG28-M32	ODB28-M32	OGPA 21	23,5 x 28,4	25	1,45
ODG34-M40	ODB34-M40	OGPA 29	29 x 34,5	20	2,25
ODG42-M50	ODB42-M50	OGPA 36	36 x 42,5	15	3,05
ODG54-M50	ODB54-M50	OGPA 48	48 x 54,5	10	3,85

**PG DİŞ GEÇMELİ TİP 90° DİRSEK RAKORLAR**

Gri Kod	Siyah Kod	Spiral Kod	Spiral Ölçü mm.	Kutu Adedi	Birim Fiyatı €
ODDG10-PG7	ODDB10-PG7	OGPA 7	6,5 x 10	75	1,50
ODDG13-PG9	ODDB13-PG9	OGPA 9	10 x 13	50	1,70
ODDG15-PG11	ODDB15-PG11	OGPA 11	12 x 15,8	50	1,84
ODDG18-PG13,5	ODDB18-PG13,5	OGPA 13,5	14,2 x 18,4	50	2,23
ODDG21-PG16	ODDB21-PG16	OGPA 16	16,5 x 21,2	40	2,60
ODDG28-PG21	ODDB28-PG21	OGPA 21	23,5 x 28,4	25	2,98
ODDG34-PG29	ODDB34-PG29	OGPA 29	29 x 34,5	15	6,35
ODDG42-PG36	ODDB42-PG36	OGPA 36	36 x 42,5	5	8,60
ODDG54-PG48	ODDB54-PG48	OGPA 48	48 x 54,5	5	10,72

**Metrik**

ODDG10-M12	ODDB10-M12	OGPA 7	6,5 x 10	75	1,50
ODDG13-M16	ODDB13-M16	OGPA 9	10 x 13	50	1,70
ODDG15-M16	ODDB15-M16	OGPA 11	12 x 15,8	50	1,84
ODDG18-M20	ODDB18-M20	OGPA 13,5	14,2 x 18,4	50	2,23
ODDG21-M20	ODDB21-M20	OGPA 16	16,5 x 21,2	40	2,60
ODDG28-M25	ODDB28-M25	OGPA 21	23,5 x 28,4	25	2,98

**PG DİŞ GEÇMELİ TİP KABLO TUTUCU RAKORLAR**

Siyah Kod	Spiral Kod	Sıkma Aralığı mm.	Kutu Adedi	Birim Fiyat €
ODBR10-PG7	OGPA 7	3,5-6	50	0,59
ODBR12-PG7	OGPA 8,5	3,5-6	50	0,59
ODBR13-PG9	OGPA 9	4,5-7	50	0,65
ODBR15-PG11	OGPA 11	6-9	50	0,78
ODBR18-PG13,5	OGPA 13,5	9-12	50	0,89
ODBR21-PG16	OGPA 16	11-14	50	1,10
ODBR28-PG21	OGPA 21	14-18	50	1,69
ODBR34-PG29	OGPA 29	18-25	25	2,33
ODBR42-PG36	OGPA 36	25-32	10	3,43

**POLYAMİD KAPAKLI KROŞELER**

Gri Kod	Siyah Kod	Spiral Kod	Spiral Ölçü mm.	Kutu Adedi	Birim Fiyat €
ODGK10	ODBK10	OGPA 7	10	50	0,25
ODGK13	ODBK13	OGPA 9	13	50	0,27
ODGK15	ODBK15	OGPA 11	15,8	50	0,28
ODGK18	ODBK18	OGPA 13,5	18,4	50	0,30
ODGK21	ODBK21	OGPA 16	21,2	50	0,32
ODGK28	ODBK28	OGPA 21	28,4	25	0,37
ODGK34	ODBK34	OGPA 29	34,5	25	0,65
ODGK42	ODBK42	OGPA 36	42,5	25	0,85
ODGK54	ODBK54	OGPA 48	54,5	10	0,97

**POLYAMİD T - Y DAĞITICI ELEMANLARI (HER YÖNE)**

Gri Kod	Siyah Kod	Spiral Ölçü mm.	Kutu Adedi	Birim Fiyat €
ODGYT101010	ODBYT101010	9/9/9	10	13,20
ODGYT121212	ODBYT121212	11/11/11	10	13,20
ODGYT121010	ODBYT121010	11/9/9	10	13,20
ODGYT171717	ODBYT171717	16/16/16	10	13,20
ODGYT171212	ODBYT171212	16/11/11	10	13,20
ODGYT171010	ODBYT171010	16/9/9	10	13,20
ODGYT231717	ODBYT231717	21/16/16	10	25,71

**POLYAMİD T DAĞITICI ELEMANLARI**

Siyah Kod	Spiral Ölçü mm.	Kutu Adedi	Birim Fiyat €
ODBT121212	9/9/9	10	6,51
ODBT161212	11/9/9	10	6,95
ODBT161216	11/9/11	10	6,95
ODBT161612	11/11/9	10	6,95
ODBT161616	11/11/11	10	6,95
ODBT201216	16/9/11	10	8,13
ODBT201616	16/11/11	10	8,13
ODBT201620	16/11/16	10	8,13
ODBT202016	16/16/11	10	8,13
ODBT202020	16/16/16	10	8,82
ODBT281620	21/11/16	10	12,01
ODBT282020	21/16/16	10	12,01
ODBT281628	21/11/21	10	12,01
ODBT282028	21/16/21	10	12,01
ODBT282828	21/21/21	10	12,01
ODBT321632	29/11/29	10	15,44
ODBT322032	29/16/29	10	15,44

**POLYAMİD Y DAĞITICI ELEMANLARI**

Siyah Kod	Spiral Ölçü mm.	Kutu Adedi	Birim Fiyat €
ODBY121212	9/9/9	10	6,59
ODBY161212	11/9/9	10	7,08
ODBY161208	11/9/6	10	7,08
ODBY161608	11/11/6	10	7,08
ODBY201212	16/9/9	10	8,48
ODBY201612	16/11/9	10	8,48
ODBY202012	16/16/9	10	8,48
ODBY202016	16/16/11	10	8,48
ODBY282012	21/16/9	10	12,26
ODBY282016	21/16/11	10	12,26
ODBY282812	21/21/9	10	12,26
ODBY282816	21/21/11	10	12,26
ODBY282828	21/21/21	10	12,26

**SENSÖR RAKORLARI**

Siyah Kod	Spiral Kod	Metrik Diş	Birim Fiyatı €
ODBS-10M08	OSPA7	M 8 x 1	6,83
ODBS-10M12	OSPA9	M 12 x 1	6,83
ODBS-10M18	OSPA9	M 18 x 1	6,83
ODBS-10M30	OSPA9	M 30 x 1,5	11,38

**FLANŞLI RAKORLAR**

Siyah Kod	Spiral Kod	Metrik Diş	Birim Fiyatı €
ODBF-16	OSPA16	10	6,37
ODBF-21	OSPA21	10	9,56
ODBF-29	OSPA29	10	14,33
ODBF-36	OSPA36	10	21,50
ODBF-48	OSPA48	10	29,58



**MATUFLESS PVC DIŞLI SİRAL BORU GRİ/SİYAH**

Gri Kod	İç Çap mm.	Dış Çap mm.	Ambalaj Miktarı	Birim Fiyatı €
GGX 8	8	12	03	0,76
GGX 10	10	14,5	30	0,83
GGX 12	12	16,3	30	0,87
GGX 14	14	18,6	30	0,91
GGX 16	16	20,5	30	1,00
GGX 20	20	24,7	30	1,34
GGX 22	22	27	30	1,53
GGX 25	25	30,3	30	1,90
GGX 28	28	33,2	30	2,29
GGX 32	32	37,5	30	2,65
GGX 35	35	40,5	30	2,83
GGX 38	38	44,1	30	3,28
GGX 40	40	46,2	30	4,68
GGX 50	50	57	30	5,27
GGX 60	60	67	30	7,39



**MATUFLESS PVC RAKORLARI**
**PG - Metrik Serisi**

PG Kod	Metrik Kod	PG	İç Çap Metrik	Ambalaj Miktarı	Birim Fiyatı €
RGP8-PG7	RGM8-M12	8	8	50	0,86
RGP10-PG7	-	10	-	50	0,86
RGP10-PG9	RGM10-M16	10	10	50	0,86
RGP12-PG9	-	12	-	50	0,86
RGP12-PG11	RGM12-M16	12	12	50	0,86
RGP12-PG13,5	-	12	-	50	0,86
RGP14-PG11	-	14	-	50	0,86
RGP14-PG13,5	RGM14-M20	14	14	50	1,21
RGP16-PG13,5	-	16	-	50	1,21
RGP16-PG16	RGM16-M20	16	16	50	1,41
RGP20-PG16	-	20	-	25	1,41
RGP20-PG21	RGM20-M25	20	20	25	1,50
RGP22-PG21	RGM22-M25	22	22	25	1,83
RGP25-PG29	RGM25-M32	25	25	25	2,18
RGP28-PG29	RGM28-M32	28	28	25	2,45
RGP32-PG36	RGM32-M40	32	32	10	3,23
RGP35-PG36	RGM35-M40	35	35	10	4,06
RGP40-PG42	RGM40-M50	40	40	10	4,89
RGP50-PG48	RGM50-M63	50	50	10	6,00



**GALVANİZ SPİRAL BORULAR**

Kod	Ölçü mm.	Ambalaj Miktarı mt.	Birim Fiyatı TL
OCGS 7	7 x 10,5	50	2,00
OCGS 9	9 x 12	50	2,00
OCGS 10	10 x 13 1/4"	50	2,30
OCGS 11	11 x 14	50	2,33
OCGS 13	13 x 16 3/8"	50	2,49
OCGS 14	14 x 17	50	2,49
OCGS 16	16 x 19 1/2"	50	2,78
OCGS 18	18 x 21	50	3,28
OCGS 21	21 x 24 3/4"	50	3,80
OCGS 26	26 x 29 1"	25	5,29
OCGS 29	29 x 33	25	5,60
OCGS 32	32 x 36	25	6,55
OCGS 35	35 x 39 1-1/4"	25	6,76
OCGS 37	37 x 41	25	7,12
OCGS 40	40 x 44 1-1/2"	25	7,74
OCGS 42	42 x 46	25	7,74
OCGS 45	45 x 49	25	9,23
OCGS 51	51 x 55 2"	25	10,50
OCGS 63	63 x 67 2-1/2"	25	Fiyat İsteyiniz
OCGS 75	75 x 80 3"	25	Fiyat İsteyiniz

**PVC KAPLI GALVANİZ SPİRAL BORULAR**

Kod	Ölçü mm.	Ambalaj Miktarı mt.	Birim Fiyatı TL
OPCGS 7	7 x 11,5	50	3,05
OPCGS 9	9 x 12,5	50	3,05
OPCGS 10	10 x 13 1/4"	50	3,40
OPCGS 11	11 x 15	50	3,44
OPCGS 13	13 x 17 3/8"	50	3,84
OPCGS 14	14 x 18	50	3,86
OPCGS 16	16 x 20 1/2"	50	4,24
OPCGS 18	18 x 22	50	4,73
OPCGS 21	21 x 25 3/4"	50	5,97
OPCGS 26	26 x 31 1"	25	6,76
OPCGS 29	29 x 34	25	8,26
OPCGS 32	32 x 37	25	8,58
OPCGS 35	35 x 40 1-1/4"	25	8,97
OPCGS 37	37 x 42	25	9,66
OPCGS 40	40 x 45 1-1/2"	25	10,31
OPCGS 42	42 x 47	25	11,50
OPCGS 45	45 x 50	25	13,46
OPCGS 51	51 x 56 2"	25	15,77
OPCGS 63	63 x 68 2-1/2"	15	Fiyat İsteyiniz
OPCGS 75	75 x 83 3"	15	Fiyat İsteyiniz

**AĞIR HİZMET PVC KAPLI ÇELİK SPİRAL BORULAR**

Kod	Ölçü mm.	Ambalaj Miktarı mt.	Birim Fiyatı USD
LGT 10	10 x 16 1/4"	30	3,22 \$
LGT 12	13 x 18 3/8"	30	3,40 \$
LGT 16	16 x 21 1/2"	30	3,53 \$
LGT 21	21 x 26 3/4"	30	4,86 \$
LGT 27	27 x 33 1"	25	8,21 \$
LGT 35	35 x 42 1-1/4"	15	10,88 \$
LGT 40	40 x 48 1-1/2"	15	13,50 \$
LGT 51	52 x 60 2"	15	17,81 \$
LGT 63	63 x 73 2-1/2"	7,5	20,67 \$
LGT 78	78 x 88 3"	7,5	38,48 \$
LGT 102	102 x 114 4"	7,5	48,00 \$

**TERMOPLASTİK TPV KAPLI GALVANİZ SİRİAL BORULAR**

\*1.000 m. ve üzeri üretim yapılabilir.

Kod	Ölçü mm.	Ambalaj Miktarı mt.	Birim Fiyatı TL	Halogen Free
OPCHF 7	7 x 10,5	1/4"	50	7,04
OPCHF 9	9 x 12,5	3/8"	50	7,90
OPCHF 11	11 x 15		50	8,80
OPCHF 14	14 x 18		50	9,77
OPCHF 16	16 x 20	1/2"	50	11,25
OPCHF 18	18 x 22		50	13,08
OPCHF 21	21 x 25	3/4"	50	20,90
OPCHF 26	26 x 31	1"	25	27,26
OPCHF 29	29 x 35		25	27,43
OPCHF 32	32 x 37		25	30,81
OPCHF 35	35 x 40	1-1/4"	25	34,37
OPCHF 37	37 x 42		25	41,91
OPCHF 40	40 x 45	1-1/2"	25	49,42
OPCHF 42	42 x 47		25	56,81
OPCHF 45	45 x 50		25	65,31
OPCHF 50	51 x 56	2"	25	

**KILAVUZ TELLİ GALVANİZ SİRİAL BORULAR**

Kod	Ölçü mm.	Ambalaj Miktarı mt.	Birim Fiyatı TL	TSE
OCGS11K	11 x 14	3/8"	50	2,87
OCGS14K	14 x 17		50	3,05
OCGS16K	16 x 19	1/2"	50	3,44
OCGS18K	18 x 21		50	4,04
OCGS21K	21 x 24	3/4"	50	4,73
OCGS26K	26 x 30	1"	25	6,52
OCGS29K	29 x 33		25	6,91
OCGS37K	37 x 41	1-1/4"	25	8,78
OCGS42K	42 x 46		25	9,54
OCGS51K	51 x 55	2"	25	12,99

**KILAVUZ TELLİ PVC KAPLI GALVANİZ SİRİAL BORULAR**

Kod	Ölçü mm.	Ambalaj Miktarı mt.	Birim Fiyatı TL	TSE
OPCGS11K	11 x 15	3/8"	50	4,24
OPCGS14K	14 x 18		50	4,74
OPCGS16K	16 x 20	1/2"	50	5,23
OPCGS18K	18 x 22		50	5,82
OPCGS21K	21 x 25	3/4"	50	7,36
OPCGS26K	26 x 31	1"	25	8,31
OPCGS29K	29 x 34		25	10,18
OPCGS37K	37 x 42	1-1/4"	25	11,90
OPCGS42K	42 x 47		25	14,17
OPCGS51K	51 x 56	2"	25	20,12

**ÇELİK TEL ÖRGÜLÜ GALVANİZ SİRİAL BORULAR**

Kod	Ölçü mm.	Ambalaj Miktarı mt.	Birim Fiyatı TL	TSE
CTS 10	10 x 15	1/4"	50	14,20
CTS 13	13 x 17,5	3/8"	50	15,84
CTS 16	16 x 21	1/2"	50	18,53
CTS 21	21 x 26	3/4"	50	23,36
CTS 26	26 x 31	1"	25	29,92
CTS 35	35 x 41	1-1/4"	25	39,69
CTS 40	40 x 46	1-1/2"	25	44,95
CTS 51	51 x 57	2"	25	57,47

**ÇELİK TEL ÖRGÜLÜ PVC KAPLI GALVANİZ SİRİAL BORULAR**

Kod	Ölçü mm.	Ambalaj Miktarı mt.	Birim Fiyatı TL	TSE
CTPS 10	10 x 16	1/4"	50	16,51
CTPS 13	13 x 18,5	3/8"	50	18,69
CTPS 16	16 x 22	1/2"	50	21,56
CTPS 21	21 x 27	3/4"	50	28,00
CTPS 26	26 x 32	1"	25	33,70
CTPS 35	35 x 42	1-1/4"	25	43,87
CTPS 40	40 x 47	1-1/2"	25	49,70
CTPS 51	51 x 58	2"	25	66,43



## PİRİNÇ SİRAL BORU RAKORLARI (SOMUNSUZ)

Sabit Tip-IP 55

PG Kod	PG Diş	Metrik Kod	Metrik Diş	Gas Kod	Gas Diş	Spiral Ölçü mm.	Birim Fiyatı TL
MPR 7	PG 7	MMR 12	M 12	MGR 14	1/4"	OPCS7	7,65
MPR 9	PG 9	MMR 16	M 16	MGR 38	3/8"	OPCS9	8,53
MPR 11	PG 11	MMR 116	M 16	MGR 138	3/8"	OPCS11	10,30
MPR 13,5	PG 13,5	MMR 20	M 20	MGR 12	1/2"	OPCS14	12,17
MPR 16	PG 16	MMR 120	M 20	MGR 122	1/2"	OPCS16	12,17
MPR 21	PG 21	MMR 25	M 25	MGR 34	3/4"	OPCS21	17,00
MPR 29	PG 29	MMR 32	M 32	MGR 100	1"	OPCS26	31,72
MPR 36	PG 36	MMR 40	M 40	MGR 114	1 1/4"	OPCS35	48,67
MPR 42	PG 42	MMR 50	M 50	MGR 112	1 1/2"	OPCS40	67,00
MPR 48	PG 48	MMR 63	M 63	MGR 200	2"	OPCS51	77,22
<b>Döner tip-IP 55</b>							
MDP 7	PG 7	MDM 12	M 12	MDG 14	1/4"	OPCS7	9,10
MDP 9	PG 9	MDM 16	M 16	MDG 38	3/8"	OPCS9	10,92
MDP 11	PG 11	MDM 116	M 16	MDG 138	3/8"	OPCS11	12,74
MDP 13,5	PG 13,5	MDM 20	M 20	MDG 12	1/2"	OPCS14	15,60
MDP 16	PG 16	MDM 120	M 20	MDG 122	1/2"	OPCS16	16,43
MDP 21	PG 21	MDM 25	M 25	MDG 34	3/4"	OPCS21	27,35
MDP 29	PG 29	MDM 32	M 32	MDG 100	1"	OPCS26	35,36
MDP 36	PG 36	MDM 40	M 40	MDG 114	1 1/4"	OPCS35	60,84
MDP 42	PG 42	MDM 50	M 50	MDG 112	1 1/2"	OPCS40	74,20
MDP 48	PG 48	MDM 63	M 63	MDG 200	2"	OPCS51	107,64

## HARİCİ TİP PİRİNÇ SİRAL BORU RAKORLARI (SOMUNSUZ)

Sabit Tip-IP67

PG Kod	PG Diş	Metrik Kod	Metrik Diş	NPT Kod	NPT Diş	Spiral Ölçü İç Çap/mm.	Birim Fiyatı TL
LSRP 00	PG 7	LSRM 00	12 x 1,5	LSRN 00	1/4"	LGT10	10,66
LSRP 01A	PG 9	LSRM 1A	16 x 1,5	LSRN 1A	3/8"	LGT10	12,74
LSRP 01	PG 11	LSRM 01	16 x 1,5	LSRN 01	3/8"	LGT13	12,74
LSRP 2A	PG 13,5	-	-	-	-	LGT16	14,25
LSRP 02	PG 16	LSRM 02	20 x 1,5	LSRN 02	1/2"	LGT16	14,25
LSRP 03	PG 21	LSRM 03	25 x 1,5	LSRN 03	3/4"	LGT21	20,18
LSRP 04	PG 29	LSRM 04	32 x 1,5	LSRN 04	1"	LGT26	31,98
LSRP 05	PG 36	LSRM 05	40 x 1,5	LSRN 05	1 1/4"	LGT35	47,06
LSRP 06	PG 42	LSRM 06	50 x 1,5	LSRN 06	1 1/2"	LGT40	68,95
LSRP 07	PG 48	LSRM 07	63 x 1,5	LSRN 07	2"	LGT51	128,38
<b>Döner Tip</b>							
LSRDP00	PG7	LSRDM 00	12 x 1,5	LSRDN00	1/4"	LGT 10	11,70
LSRDP 01A	PG 9	LSRDM 1A	16 x 1,5	LSRDN1A	1/4"	LGT 10	15,12
LSRDP 01	PG 11	LSRDM 01	16 x 1,5	LSRDN 01	3/8"	LGT 13	15,12
LSRP 2A	PG13,5	-	-	-	-	LGT 16	17,63
LSRDP 02	PG 16	LSRDM 02	20 x 1,5	LSRDN 02	1/2"	LGT 16	17,63
LSRDP 03	PG 21	LSRDM 03	25 x 1,5	LSRDN 03	3/4"	LGT 21	27,20
LSRDP 04	PG 29	LSRDM 04	32 x 1,5	LSRDN 04	1"	LGT 26	43,16
LSRDP 05	PG 36	LSRDM 05	40 x 1,5	LSRDN 05	1 1/4"	LGT 35	62,47
LSRDP 06	PG42	LSRDM 06	50 x 1,5	LSRDN 06	1 1/2"	LGT 40	75,71
LSRDP 07	PG48	LSRDM 07	50 x 1,5	LSRDN 07	2"	LGT 51	156,00

## HARİCİ TİP KABLO TUTUCULU SİRAL RAKORU (SOMUNSUZ)

Sabit Tip-IP67

PG Kod	Ölçü	Spiral Ölçüsü	Kablo Sıkma Aralığı	Birim Fiyatı TL
MLSRP 1A	PG 9	10 - 1/4"	4-8	
MLSRP 01	PG 11	13 - 3/8"	5-10	
MLSRP 2A	PG 13,5	16 - 1/2"	6-12	
MLSRP 02	PG 16	16 - 1/2"	10-14	
MLSRP 03	PG 21	21 - 3/4"	13-18	
MLSRP 04	PG 29	26 - 1"	18-25	
MLSRP 05	PG 36	35 - 1 1/4"	22-32	
MLSRP 06	PG 42	40 - 1 1/2"	30-38	
MLSRP 07	PG 48	51 - 2"	34-44	
<b>Metrik Kod</b>				
MLSRM 1A	M 16 X 1,5	10 - 1/4"	4-8	
MLSRM01	M 16 X 1,5	13 - 3/8"	4-8	
MLSRM 02	M 20 X 1,5	16 - 1/2"	6-12	
MLSRM 03	M 25 X 1,5	21 - 3/4"	10-14	
MLSRM 04	M 32 X 1,5	26 - 1"	13-18	
MLSRM 05	M 40 X 1,5	35 - 1 1/4"	18-25	
MLSRM 06	M 50 X 1,5	40 - 1 1/2"	22-32	
MLSRM 07	M 63 X 1,5	51 - 2"	34-44	



**ÇELİK TEL ÖRGÜLÜ POLYAMİD SİRAL RAKORLARI (Somunsuz)**

PG Kod	Metrik Kod	Spiral Ölçü Dış Çap/mm.	Birim Fiyatı TL
LSRPAG-13-PG9	LSRPAG-13-M16	13	
LSRPAG-15-PG11	LSRPAG-15-M16	15,8	
LSRPAG-18-PG13,5	LSRPAG-18-M20	18	
LSRPAG-21-PG16	LSRPAG-21-M20	21	
LSRPAG-28-PG21	LSRPAG-28-M25	28	
LSRPAG-34-PG29	LSRPAG-34-M32	34	
LSRPAG-42-PG36	LSRPAG-42-M40	42	
LSRPAG-54-PG48	LSRPAG-54-M63	54	

**Döner Tip**

LSRDPAG-13-PG9	LSRDPAG-13-M16	13	
LSRDPAG-15-PG11	LSRDPAG-15-M16	15,8	
LSRDPAG-18-PG13,5	LSRDPAG-18-M20	18	
LSRDPAG-21-PG16	LSRDPAG-21-M20	21	
LSRDPAG-28-PG21	LSRDPAG-28-M25	28	
LSRDPAG-34-PG29	LSRDPAG-34-M32	34	
LSRDPAG-42-PG36	LSRDPAG-42-M40	42	
LSRDPAG-54-PG48	LSRDPAG-54-M63	54	



- İstenilen ölçüde özel üretilebilir.

**PG SİRAL BORU RAKORLARI**

Kod	Ölçü	Uygun Spiral	Ambalaj Miktarı	Birim Fiyatı TL
OHG 01	PG 7	OPCS 9	400	0,75
OHG 02	PG 9	OPCS 11	300	0,80
OHG 03	PG 11	OPCS 14	200	0,98
OHG 04	PG 13,5	OPCS 16	150	1,09
OHG 05	PG 16	OPCS 18	125	1,17
OHG 06	PG 21	OPCS 23	75	1,73
OHG 07	PG 29	OPCS 32	40	2,27
OHG 08	PG 36	OPCS 40	30	3,63
OHG 09	PG 48	OPCS 51	15	4,95

**METRİK SİRAL BORU RAKORLARI**

M 12	MHG 01	OPCS 9	400	0,95
M 16K	MHG 02	OPCS 11	300	1,02
M 16	MHG 03	OPCS 14	200	1,28
M 20	MHG 04	OPCS 16	150	1,44
M 20K	MHG 05	OPCS 18	125	1,55
M 25	MHG 06	OPCS 23	75	2,31
M 40	MHG 07	OPCS 32	40	3,03
M 50	MHG 08	OPCS 40	30	5,59
M 63	MHG 09	OPCS 51	15	6,84

**PVC ENTÜL (Sonlandırıcı)**

KE 01	1/2"	50	1,17
KE 02	3/4"	50	1,26
KE 03	1"	50	1,40
KE 04	1 1/4"	25	1,65
KE 05	1 1/2"	25	1,91
KE 06	2"	25	4,07

**P KLİPSLER**

PKL 1	PG 7	OPCS 7	100	0,71
PKL 2	PG 9	OPCS 9	100	0,73
PKL 3	PG 11	OPCS 11	100	0,76
PKL 4	PG 13,5	OPCS 14	100	0,85
PKL 5	PG 16	OPCS 16	100	0,86
PKL 6	PG 21	OPCS 21	100	0,94
PKL 7	PG 29	OPCS 29	50	1,01
PKL 8	PG 36	OPCS 35	50	1,14
PKL 9	PG 48	OPCS 51	50	1,62



**HAREKETLİ KABLO KANALLARI**

Kod	A İç Yükseklik	B İç Genişlik	C Dış Yükseklik	D Dış Genişlik	R Kıvrılma Yarıçapı	Birim Fiyatı €
-----	-------------------	------------------	--------------------	-------------------	------------------------	-------------------

**7'lik AÇIK SERİ (SABİT ÇİTALİ)**

OK07 F 007 R018	7	7	10	12	18	13,02
OK07 F 016 R018	7	16	10	21	18	14,32
OK07 P 007	7x7 Ayak Bağlantı					3,91
OK07 P 016	7x16 Ayak Bağlantı					3,91

**10'luk AÇIK SERİ (SABİT ÇİTALİ)**

OK10 F 010 R018	10	10	14	16	18	13,02
OK10 F 020 R018	10	20	14	26	18	14,32
OK10 F 030 R018	10	30	14	36	18	15,62
OK10 P 010	10x10 Ayak Bağlantı					3,91
OK10 P 020	10x20 Ayak Bağlantı					3,91
OK10 P 030	10x30 Ayak Bağlantı					3,91

**15'lik AÇIK SERİ**

OK15 F 015 R..	15	15	20	23	25-35	13,02
OK15 F 020 R..	15	20	20	28	25-35	13,02
OK15 F 030 R..	15	30	20	38	25-35	14,32
OK15 F 040 R..	15	40	20	48	25-35	16,93
OK15 A 015 R..	15	15	20	23	25-35	18,23
OK15 B 015 R..	15	15	20	23	25-35	18,23
OK15 B 020 R..	15	20	20	28	25-35	18,23
OK15 B 030 R..	15	30	20	38	25-35	19,53
OK15 B 040 R..	15	40	20	48	25-35	20,83
OK15 P015	15X15 Plastik Ayak Bağlantı					3,91
OK15 P020	15X20 Plastik Ayak Bağlantı					3,91
OK15 P030	15X30 Plastik Ayak Bağlantı					3,91
OK15 P040	15X40 Plastik Ayak Bağlantı					5,21



AÇIK TİP

**20'lik AÇIK - YARI AÇIK SERİ**

OK20 A 025R040	20	25	26	37	40	15,62
OK20 Y 025R040	20	25	26	37	40	23,44
OK20 Y 040R040	20	40	26	52	40	26,04
OK20 Y 050R040	20	50	26	62	40	28,64
OK20 Y 060R040	20	60	26	72	40	31,25
OK20 P025	20X25 Plastik Ayak Bağlantı					5,21
OK20 P040	20X40 Plastik Ayak Bağlantı					5,21
OK20 P050	20X50 Plastik Ayak Bağlantı					6,51
OK20 P060	20X60 Plastik Ayak Bağlantı					6,51



YARI AÇIK TİP

**24'lük AÇIK SERİ**

OK24 A 025R..	24	25	32	39	40-75-100-125	28,64
OK24 A 040R..	24	40	32	54	40-75-100-125	31,25
OK24 A 050R..	24	50	32	64	40-75-100-125	33,85
OK24 A 060R..	24	60	32	74	40-75-100-125	36,46
OK24 B 060R..	24	60	32	74	40-75-100-125	36,46
OK24 P 025	24X25 Plastik Ayak Bağlantı					7,81
OK24 P 040	24X40 Plastik Ayak Bağlantı					7,81
OK24 P 050	24X50 Plastik Ayak Bağlantı					7,81
OK24 P 060	24X60 Plastik Ayak Bağlantı					7,81
OK24 SP	24 Separatör					0,26

**25'lik AÇIK SERİ**

OK25 A 040R..	25	40	42	62	40-75-100-125	37,76
OK25 A 050R..	25	50	42	72	40-75-100-125	39,06
OK25 A 060R..	25	60	42	82	40-75-100-125	40,36
OK25 A 080R..	25	80	42	102	40-75-100-125	42,97
OK25 A 0100R..	25	100	42	122	40-75-100-125	45,57
OK 25 P	25'lik Plastik Ayak Bağlantı					7,81
OK 25 M	25'lik Metal Ayak Bağlantı					11,72
OK 25 SPF	25'lik Separatör Sabitleyici					0,20
OK 25 SP	25'lik Separatör					0,26





**HAREKETLİ KANALLAR**

Kod	A İç Yükseklik	B İç Genişlik	C Dış Yükseklik	D Dış Genişlik	R Kıvrılma Yarıçapı	Birim Fiyatı €
-----	-------------------	------------------	--------------------	-------------------	------------------------	-------------------

**30'luk AÇIK SERİ**

OK30 A 040R..	30	40	47	62	50-75-100-150	41,66
OK30 A 050R..	30	50	47	72	50-75-100-150	42,97
OK30 A 060R..	30	60	47	82	50-75-100-150	44,27
OK30 A 080R..	30	80	47	102	50-75-100-150	46,87
OK30 A 100R..	30	100	47	122	50-75-100-150	49,48
OK 30 P		30'luk Plastik Ayak Bağlantı				9,11
OK 30 M		30'luk Metal Ayak Bağlantı				11,72
OK 30 SPF		30'luk Separatör Sabitleyici				0,20
OK 30 SP		30'luk Separatör				0,33

**AÇIK TİP**
**35'lik AÇIK SERİ**

OK35 A 040R..	35	40	52	64	50-75-100-150	41,66
OK35 A 050R..	35	50	52	74	50-75-100-150	42,97
OK35 A 060R..	35	60	52	84	50-75-100-150	44,27
OK35 A 080R..	35	80	52	104	50-75-100-150	46,87
OK35 A 100R..	35	100	52	124	50-75-100-150	49,48
OK35 A 120R..	35	120	52	144	50-75-100-150	52,08
OK35 A 125R..	35	125	52	149	50-75-100-150	54,68

**35'lik YARI AÇIK SERİ**

OK35 Y 040R..	35	40	52	64	100-150	44,27
OK35 Y 060R..	35	60	52	84	100-150	46,87
OK35 Y 080R..	35	80	52	104	100-150	49,48
OK35 Y 100R..	35	100	52	124	100-150	52,08
OK35 Y 125R..	35	125	52	149	100-150	54,68

**35'lik KAPALI SERİ**

OK35 K 040R..	35	40	52	64	100-150	44,27
OK35 K 060R..	35	60	52	84	100-150	46,87
OK35 K 080R..	35	80	52	104	100-150	49,48
OK35 K 100R..	35	100	52	124	100-150	52,08
OK35 K 125R..	35	125	52	149	100-150	54,68
OK35 P		35'lik Plastik Ayak Bağlantı				10,42
OK35 M		35'lik Metal Ayak Bağlantı				13,02
OK35 SP		35'lik Separatör				0,33

**YARI AÇIK TİP**
**40'lik AÇIK - YARI AÇIK - KAPALI SERİ**

OK40 A 080R..	40	80	62	108	75-100-125-150-200-300	67,70
OK40 A 100R..	40	100	62	128	75-100-125-150-200-300	70,31
OK40 A 120R..	40	120	62	148	75-100-125-150-200-300	72,91
OK40 A 140R..	40	140	62	168	75-100-125-150-200-300	75,52
OK40 A 160R..	40	160	62	188	75-100-125-150-200-300	78,12
OK40 A 180R..	40	180	62	208	75-100-125-150-200-300	80,72
OK40 A 200R..	40	200	62	228	75-100-125-150-200-300	83,33
OK40 K 100R..	40	100	62	128	125-150-200-250-300	91,14
OK40 Y 100R..	40	100	62	128	125-150-200-250-300	91,14

**ALÜMİNYUM ÇİTALİ**

OK40 AL 250R..	40	250	62	278	75-100-125-150-200-300	91,14
OK40 AL 300R..	40	300	62	328	75-100-125-150-200-300	96,35
OK40 AL 400R..	40	400	62	428	75-100-125-150-200-300	101,56
OK40 AL 500R..	40	500	62	528	75-100-125-150-200-300	106,76
OK40 P		40'lik Plastik Ayak Bağlantı				13,02
OK40 M		40'lik Metal Ayak Bağlantı				15,62
OK40 SP		40'lik Separatör				0,46



**HAREKETLİ KANALLAR**

Kod	A İç Yükseklik	B İç Genişlik	C Dış Yükseklik	D Dış Genişlik	R Kıvrılma Yarıçapı	Birim Fiyatı €
<b>42'lik AÇIK - YARI AÇIK - KAPALI SERİ</b>						
OK42 A 040R..	42	40	58	67	75-100-150-200	44,27
OK42 A 050R..	42	50	58	77	75-100-150-200	46,87
OK42 A 060R..	42	60	58	87	75-100-150-200	49,48
OK42 A 080R..	42	80	58	107	75-100-150-200	52,08
OK42 A 100R..	42	100	58	127	75-100-150-200	54,68
OK42 A 120R..	42	120	58	147	75-100-150-200	57,29
OK42 A 125R..	42	125	58	152	75-100-150-200	59,89
OK42 Y 050R..	42	50	58	77	100-150-200	52,08
OK42 Y 080R..	42	80	58	107	100-150-200	58,59
OK42 Y 100R..	42	100	58	127	100-150-200	58,59
OK42 Y 125R..	42	125	58	152	100-150-200	71,61
OK42 K 050R..	42	50	58	77	100-150-200	52,08
OK42 K 080R..	42	80	58	107	100-150-200	58,59
OK42 K 100R..	42	100	58	127	100-150-200	58,59
OK42 K 125R..	42	125	58	152	100-150-200	71,61
OK42 P	42'lik Plastik Ayak Bağlantı					11,72
OK42 M	42'lik Metal Ayak Bağlantı					14,32
OK42 SP	42'lik Separatör					0,39
<b>60'lik AÇIK - YARI AÇIK - KAPALI SERİ</b>						
OK60 A 080R..	60	80	82	112	100-150-200-250-300	80,72
OK60 A 100R..	60	100	82	132	100-150-200-250-300	83,33
OK60 A 120R..	60	120	82	152	100-150-200-250-300	85,93
OK60 A 140R..	60	140	82	172	100-150-200-250-300	88,54
OK60 A 160R..	60	160	82	192	100-150-200-250-300	91,14
OK60 A 180R..	60	160	82	212	100-150-200-250-300	93,74
OK60 A 200R..	60	200	82	232	100-150-200-250-300	96,35
OK60 K 100R..	60	100	82	132	150-200-250-300	104,16
OK60 K 140R..	60	140	82	172	150-200-250-300	117,18
OK60 K 200R..	60	200	82	232	150-200-250-300	130,20
OK60 Y 100R..	60	100	82	132	150-200-250-300	104,16
OK60 Y 140R..	60	140	82	172	150-200-250-300	117,18
OK60 Y 200R..	60	200	82	232	150-200-250-300	130,20
<b>ALÜMİNYUM ÇİTALI</b>						
OK60 AL 250R..	60	250	82	282	100-150-200-250-300	104,16
OK60 AL 300R..	60	300	82	332	100-150-200-250-300	109,37
OK60 AL 400R..	60	400	82	432	100-150-200-250-300	114,58
OK60 AL 500R..	60	500	82	532	100-150-200-250-300	119,78
OK60 P	60'lik Plastik Ayak Bağlantı					14,32
OK60 M	60'lik Metal Ayak Bağlantı					16,93
OK60SP	60'lik Separatör					0,52

**80'lik AÇIK SERİ**

OK80 A 080R..	80	80	102	112	150-200-250-300	93,74
OK80 A 100R..	80	100	102	132	150-200-250-300	96,35
OK80 A 120R..	80	120	102	152	150-200-250-300	98,95
OK80 A 140R..	80	140	102	172	150-200-250-300	101,56
OK80 A 160R..	80	160	102	192	150-200-250-300	104,16
OK80 A 180R..	80	180	102	212	150-200-250-300	106,76
OK80 A 200R..	80	200	102	232	150-200-250-300	109,37

**ALÜMİNYUM ÇİTALI**

OK80 AL 257R..	80	250	102	282	100-150-200-250-300	117,18
OK80 AL 340R..	80	300	102	332	100-150-200-250-300	122,39
OK80 AL 400R..	80	400	102	432	100-150-200-250-300	127,60
OK80 AL 500R..	80	500	102	532	100-150-200-250-300	132,80
OK80 M	80'lik Metal Ayak Bağlantı					19,53
OK80SP	80'lik Separatör					0,65

- L** Kullanılacak Miktar  
Calculation of the chain length
- HM** Hareket Mesafesi  
Movement Distance
- Y** Radius Mesafesi  
Radius Distance
- X** Montaj Yüksekliği  
Mounting Height
- H** Hatve  
Pitch

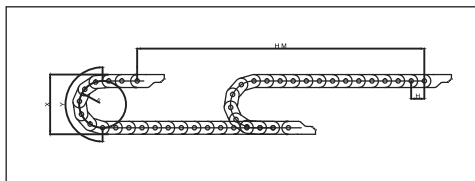

$$L = HM/2 + Y$$

$$X = R \times 2 + C$$

$$Y = R \times \pi$$

B ..... ÇİTALARI DIŞTAN AÇILIR  
F ..... SABİT ÇİTALI AÇILMAZ  
A ..... ÇİTASI İÇTEN AÇILIR

AL ..... ALÜMİNYUM ÇİTALI  
K ..... KOMPLE KAPALI KAPAK  
Y ..... ALTI KAPALI ÜSTÜ ÇİTALI



# ORTAC®

Kablo Baęlantı Elemanları



**EMT, IMC, RSC BORULAR & AKSESUARLARI**

*EMT, IMC, RSC CONDUITS & ACCESSORIES*

**EMT GALVANİZ BORULAR**
**ANSI C80.3 - UL 797**

Kod	Ölçü mm.	Dış Çap mm.	Et Kalınlık	Ağırlık	Ambalaj	Rulo Boyu m.	Birim Fiyatı mt. / USD
GB-050	1/2"	17,9	1,07	1,36	10	3,05	Teklif İsteyiniz
GB-075	3/4"	23,4	1,25	2,09	10	3,05	Teklif İsteyiniz
GB-100	1"	29,5	1,45	3,04	10	3,05	Teklif İsteyiniz
GB-125	1-1/4"	38,3	1,65	4,30	5	3,05	Teklif İsteyiniz
GB-150	1-1/2"	44,2	1,65	5,20	5	3,05	Teklif İsteyiniz
GB-200	2"	55,8	1,65	6,70	3	3,05	Teklif İsteyiniz

**VİDALI TİP EMT BORU - BUAT RAKORLARI**

Kod	Ölçü mm.	Kutu Adedi	Birim Fiyatı Adet / USD
VBR 050	1/2"	50	Teklif İsteyiniz
VBR 075	3/4"	50	Teklif İsteyiniz
VBR 100	1"	50	Teklif İsteyiniz
VBR 125	1-1/4"	50	Teklif İsteyiniz
VBR 150	1-1/2"	50	Teklif İsteyiniz
VBR 200	2"	50	Teklif İsteyiniz

**VİDALI TİP EMT BORU - BİRLEŞTİRME MUFU**

Kod	Ölçü mm.	Kutu Adedi	Birim Fiyatı Adet / USD
VBM 050	1/2"	50	Teklif İsteyiniz
VBM 075	3/4"	50	Teklif İsteyiniz
VBM 100	1"	50	Teklif İsteyiniz
VBM 125	1-1/4"	50	Teklif İsteyiniz
VBM 150	1-1/2"	50	Teklif İsteyiniz
VBM 200	2"	50	Teklif İsteyiniz

**SIKMALI TİP EMT BORU  
BUAT RAKORLARI BİRLEŞTİRME MUFLARI**

Kod	Ölçü mm.	Kutu Adedi	Birim Fiyatı Adet / USD
SBR 050	1/2"	50	Teklif İsteyiniz
SBR 075	3/4"	50	Teklif İsteyiniz
SBR 100	1"	50	Teklif İsteyiniz
SBR 125	1-1/4"	50	Teklif İsteyiniz
SBR 150	1-1/2"	50	Teklif İsteyiniz
SBR 200	2"	50	Teklif İsteyiniz

**SIKMALI TİP EMT BORU  
BİRLEŞTİRME MUFLARI**

Kod	Ölçü mm.	Kutu Adedi	Birim Fiyatı Adet / USD
SBM 050	1/2"	50	Teklif İsteyiniz
SBM 075	3/4"	50	Teklif İsteyiniz
SBM 100	1"	50	Teklif İsteyiniz
SBM 125	1-1/4"	50	Teklif İsteyiniz
SBM 150	1-1/2"	50	Teklif İsteyiniz
SBM 200	2"	50	Teklif İsteyiniz

**EMT TEK KULAK BORU KROŞELERİ**

Kod	Ölçü mm.	Kutu Adedi	Birim Fiyatı Adet / USD
TKK 050	1/2"	50	Teklif İsteyiniz
TKK 075	3/4"	50	Teklif İsteyiniz
TKK 100	1"	50	Teklif İsteyiniz
TKK 125	1-1/4"	50	Teklif İsteyiniz
TKK 150	1-1/2"	50	Teklif İsteyiniz
TKK 200	2"	50	Teklif İsteyiniz

**EMT ÇİFT KULAK BORU KROŞELERİ**

Kod	Ölçü mm.	Kutu Adedi	Birim Fiyatı Adet / USD
CKK 050	1/2"	50	Teklif İsteyiniz
CKK 075	3/4"	50	Teklif İsteyiniz
CKK 100	1"	50	Teklif İsteyiniz
CKK 125	1-1/4"	50	Teklif İsteyiniz
CKK 150	1-1/2"	50	Teklif İsteyiniz
CKK 200	2"	50	Teklif İsteyiniz

**EMT BORU ASMA KELEPÇESİ**

Kod	Ölçü mm.	Kutu Adedi	Birim Fiyatı Adet / USD
BAK 050	1/2"	50	Teklif İsteyiniz
BAK 075	3/4"	50	Teklif İsteyiniz
BAK 100	1"	50	Teklif İsteyiniz
BAK 125	1-1/4"	50	Teklif İsteyiniz
BAK 150	1-1/2"	50	Teklif İsteyiniz
BAK 200	2"	50	Teklif İsteyiniz

**EMT BORU - 90° DİRSEK**

Kod	Ölçü mm.	Kutu Adedi	Birim Fiyatı Adet / USD
DE90-050	1/2"	50	Teklif İsteyiniz
DE90-075	3/4"	50	Teklif İsteyiniz
DE90-100	1"	50	Teklif İsteyiniz
DE90-125	1-1/4"	50	Teklif İsteyiniz
DE90-150	1-1/2"	50	Teklif İsteyiniz
DE90-200	2"	50	Teklif İsteyiniz



**IMC DIŐLI GALVANİZ BORULAR**
**ANSI C80.6-1242-1983**

Kod	Ölçü mm.	Dış Çap mm.	Et Kalınlık	Ağırlık	Ambalaj	Rulo Boyu m.	Birim Fiyatı mt. / USD
GBI-050	1/2"	20,7	1,8	2,8	10	3,05	Teklif İsteyiniz
GBI-075	3/4"	26	1,9	3,8	5	3,05	Teklif İsteyiniz
GBI-100	1"	32,8	2,2	5,7	5	3,05	Teklif İsteyiniz
GBI-125	1-1/4"	41,6	2,3	7,3	3	3,05	Teklif İsteyiniz
GBI-150	1-1/2"	47,8	2,3	8,5	3	3,05	Teklif İsteyiniz
GBI-200	2"	59,9	2,4	11,4	3	3,05	Teklif İsteyiniz

**IMC PANO TİPİ RAKOR (HUB)**

Kod	Ölçü mm.	Kutu Adedi	Birim Fiyatı Adet / USD
HB-050	1/2"	50	Teklif İsteyiniz
HB-075	3/4"	50	Teklif İsteyiniz
HB-100	1"	50	Teklif İsteyiniz
HB-125	1-1/4"	50	Teklif İsteyiniz
HB-150	1-1/2"	50	Teklif İsteyiniz
HB-200	2"	50	Teklif İsteyiniz

**MANŐON**

Kod	Ölçü mm.	Kutu Adedi	Birim Fiyatı Adet / USD
MON-050	1/2"	25	Teklif İsteyiniz
MON-075	3/4"	25	Teklif İsteyiniz
MON-100	1"	25	Teklif İsteyiniz
MON-125	1-1/4"	10	Teklif İsteyiniz
MON-150	1-1/2"	10	Teklif İsteyiniz
MON-200	2"	10	Teklif İsteyiniz

**IMC TEK KULAK BORU KROŐELERİ**

Kod	Ölçü mm.	Kutu Adedi	Birim Fiyatı Adet / USD
TKKI 050	1/2"	100	Teklif İsteyiniz
TKKI 075	3/4"	50	Teklif İsteyiniz
TKKI 100	1"	50	Teklif İsteyiniz
TKKI 125	1-1/4"	50	Teklif İsteyiniz
TKKI 150	1-1/2"	50	Teklif İsteyiniz
TKKI 200	2"	50	Teklif İsteyiniz

**IMC ÇİFT KULAK BORU KROŐELERİ**

Kod	Ölçü mm.	Kutu Adedi	Birim Fiyatı Adet / USD
CKKI 050	1/2"	100	Teklif İsteyiniz
CKKI 075	3/4"	50	Teklif İsteyiniz
CKKI 100	1"	50	Teklif İsteyiniz
CKKI 125	1-1/4"	50	Teklif İsteyiniz
CKKI 150	1-1/2"	50	Teklif İsteyiniz
CKKI 200	2"	50	Teklif İsteyiniz

**IMC BORU - 90° DİRSEK**

Kod	Ölçü mm.	Kutu Adedi	Birim Fiyatı Adet / USD
DEI90-050	1/2"	25	Teklif İsteyiniz
DEI90-075	3/4"	25	Teklif İsteyiniz
DEI90-100	1"	25	Teklif İsteyiniz
DEI90-125	1-1/4"	10	Teklif İsteyiniz
DEI90-150	1-1/2"	10	Teklif İsteyiniz
DEI90-200	2"	10	Teklif İsteyiniz

**IMC METAL BUSHING**

Kod	Ölçü mm.	Kutu Adedi	Birim Fiyatı Adet / USD
MCB-050	1/2"	100	Teklif İsteyiniz
MCB-075	3/4"	100	Teklif İsteyiniz
MCB-100	1"	50	Teklif İsteyiniz
MCB-125	1-1/4"	50	Teklif İsteyiniz
MCB-150	1-1/2"	50	Teklif İsteyiniz
MCB-200	2"	20	Teklif İsteyiniz
MCB-250	2 1/2"	5	Teklif İsteyiniz
MCB-300	3"	5	Teklif İsteyiniz
MCB-400	4"	5	Teklif İsteyiniz

**IMC PLASTİK BUSHING**

Kod	Ölçü mm.	Kutu Adedi	Birim Fiyatı Adet / USD
PCB-050	1/2"	100	Teklif İsteyiniz
PCB-075	3/4"	100	Teklif İsteyiniz
PCB-100	1"	50	Teklif İsteyiniz
PCB-125	1-1/4"	50	Teklif İsteyiniz
PCB-150	1-1/2"	50	Teklif İsteyiniz
PCB-200	2"	20	Teklif İsteyiniz
PCB-250	2 1/2"	5	Teklif İsteyiniz
PCB-300	3"	5	Teklif İsteyiniz
PCB-400	4"	5	Teklif İsteyiniz

**KİLİTLEME SOMUNU**

Kod	Ölçü mm.	Kutu Adedi	Birim Fiyatı Adet / USD
GCS-050	1/2"	100	Teklif İsteyiniz
GCS-075	3/4"	50	Teklif İsteyiniz
GCS-100	1"	50	Teklif İsteyiniz
GCS-125	1-1/4"	50	Teklif İsteyiniz
GCS-150	1-1/2"	50	Teklif İsteyiniz
GCS-200	2"	50	Teklif İsteyiniz
GCS-250	2 1/2"	5	Teklif İsteyiniz
GCS-300	3"	5	Teklif İsteyiniz
GCS-400	4"	5	Teklif İsteyiniz



**DAHİLİ TİP SAÇ BUAT**

102 x 102 x 38

Kod	Ölçü mm.	Kutu Adedi	Birim Fiyatı Adet / USD
DB 01	1/2"	18x1/2-3x3/4	Teklif İsteyiniz
DB 02	3/4"	10x3/4-3x1/2	Teklif İsteyiniz
DB 03	1/2"-3/4"	11x1/2-6x3/4	Teklif İsteyiniz
DBK 01	Buat Kapağı		Teklif İsteyiniz

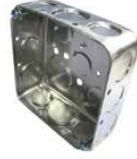
**DAHİLİ TİP SAÇ BUAT**

120 x 120 x 54

Kod	Ölçü mm.	Kutu Adedi	Birim Fiyatı Adet / USD
DB 11	1/2"	18x1/2-3x3/4	Teklif İsteyiniz
DB 13	3/4"	10x3/4-3x1/2	Teklif İsteyiniz
DB 14	1/2"-3/4"	11x1/2-6x3/4	Teklif İsteyiniz
DBK 02	Buat Kapağı		Teklif İsteyiniz

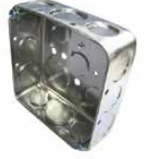
**ALÜMİNYUM DÖKÜM KONDULET**

LL-LB-LR-C

Kod	Ölçü mm.	Kutu Adedi	Birim Fiyatı Adet / USD
KON... 050	1/2"	50	Teklif İsteyiniz
KON... 075	3/4"	50	Teklif İsteyiniz
KON... 100	1"	50	Teklif İsteyiniz
KON... 125	1-1/4"	50	Teklif İsteyiniz
KON... 150	1-1/2"	50	Teklif İsteyiniz
KON... 200	2"	50	Teklif İsteyiniz

**ALÜMİNYUM DÖKÜM KONDULET**

T

Kod	Ölçü mm.	Kutu Adedi	Birim Fiyatı Adet / USD
KON T 050	1/2"	100	Teklif İsteyiniz
KON T 075	3/4"	50	Teklif İsteyiniz
KON T 100	1"	50	Teklif İsteyiniz
KON T 125	1-1/4"	50	Teklif İsteyiniz
KON T 150	1-1/2"	50	Teklif İsteyiniz
KON T 200	2"	50	Teklif İsteyiniz

**HARİCİ TİP SİRAL RAKORU-ERKEK**

Kod	Ölçü mm.	Kutu Adedi	Birim Fiyatı Adet / USD
HR-050	1/2"	50	Teklif İsteyiniz
HR-075	3/4"	50	Teklif İsteyiniz
HR-100	1"	50	Teklif İsteyiniz
HR-125	1-1/4"	30	Teklif İsteyiniz
HR-150	1-1/2"	20	Teklif İsteyiniz
HR-200	2"	10	Teklif İsteyiniz
HR-250	2 1/2"	5	Teklif İsteyiniz
HR-300	3"	5	Teklif İsteyiniz
HR-400	4"	5	Teklif İsteyiniz

**HARİCİ TİP SİRAL RAKORU-DİŞİ**

Kod	Ölçü mm.	Kutu Adedi	Birim Fiyatı Adet / USD
HRB-050	1/2"	50	Teklif İsteyiniz
HRB-075	3/4"	50	Teklif İsteyiniz
HRB-100	1"	50	Teklif İsteyiniz
HRB-125	1-1/4"	30	Teklif İsteyiniz
HRB-150	1-1/2"	20	Teklif İsteyiniz
HRB-200	2"	10	Teklif İsteyiniz
HRB-250	2 1/2"	5	Teklif İsteyiniz
HRB-300	3"	5	Teklif İsteyiniz
HRB-400	4"	5	Teklif İsteyiniz

**HARİCİ TİP 90° DİRSEK SİRAL RAKORU**

Kod	Ölçü mm.	Kutu Adedi	Birim Fiyatı Adet / USD
HRD-050	1/2"	50	Teklif İsteyiniz
HRD-075	3/4"	50	Teklif İsteyiniz
HRD-100	1"	50	Teklif İsteyiniz
HRD-125	1-1/4"	30	Teklif İsteyiniz
HRD-150	1-1/2"	20	Teklif İsteyiniz
HRD-200	2"	10	Teklif İsteyiniz
HRD-250	2 1/2"	5	Teklif İsteyiniz
HRD-300	3"	5	Teklif İsteyiniz
HRD-400	4"	5	Teklif İsteyiniz

**HARİCİ TİP EMT-FLEX BAĞLANTI RAKORU-VIDALI TİP**

Kod	Ölçü mm.	Kutu Adedi	Birim Fiyatı Adet / USD
VSEM 050	1/2"	50	Teklif İsteyiniz
VSEM 075	3/4"	50	Teklif İsteyiniz
VSEM 100	1"	50	Teklif İsteyiniz
VSEM 125	1-1/4"	30	Teklif İsteyiniz
VSEM 150	1-1/2"	20	Teklif İsteyiniz
VSEM 200	2"	10	Teklif İsteyiniz
VSEM 250	2 1/2"	5	Teklif İsteyiniz
VSEM 300	3"	5	Teklif İsteyiniz
VSEM 400	4"	5	Teklif İsteyiniz

**HARİCİ TİP EMT-FLEX BAĞLANTI RAKORU-SIKMALI TİP HARİCİ TİP FLEX-FLEX BAĞLANTI RAKORU-SIKMALI TİP**

Kod	Ölçü mm.	Kutu Adedi	Birim Fiyatı Adet / USD
HRFR 050	1/2"	50	Teklif İsteyiniz
HRFR 075	3/4"	50	Teklif İsteyiniz
HRFR 100	1"	50	Teklif İsteyiniz
HRFR 125	1-1/4"	30	Teklif İsteyiniz
HRFR 150	1-1/2"	20	Teklif İsteyiniz
HRFR 200	2"	10	Teklif İsteyiniz



Kod	Ölçü mm.	Kutu Adedi	Birim Fiyatı Adet / USD
HRF 050	1/2"	50	Teklif İsteyiniz
HRF 075	3/4"	50	Teklif İsteyiniz
HRF 100	1"	50	Teklif İsteyiniz
HRF 125	1-1/4"	30	Teklif İsteyiniz
HRF 150	1-1/2"	20	Teklif İsteyiniz
HRF 200	2"	10	Teklif İsteyiniz



**EMT BORU - SİRAL ADAPTÖRÜ**

Kod	Ölçü mm.	Kutu Adedi	Birim Fiyatı Adet / USD
VS0-050	1/2"	50	Teklif İsteyiniz
VS0-075	3/4"	50	Teklif İsteyiniz
VS0-100	1"	50	Teklif İsteyiniz

**VİDALI TİP SİRAL BUAT RAKORU**

Kod	Ölçü mm.	Kutu Adedi	Birim Fiyatı Adet / USD
VSR-050	1/2"	50	Teklif İsteyiniz
VSR-075	3/4"	50	Teklif İsteyiniz
VSR-100	1"	50	Teklif İsteyiniz

**U-BOLT (Galvaniz Çelik)**

Kod	Ölçü mm.	Kutu Adedi	Birim Fiyatı Adet / USD
UB 050	1/2"	10	Teklif İsteyiniz
UB 075	3/4"	10	Teklif İsteyiniz
UB 100	1"	10	Teklif İsteyiniz
UB 125	1-1/4"	10	Teklif İsteyiniz
UB 150	1-1/2"	10	Teklif İsteyiniz
UB 200	2"	10	Teklif İsteyiniz
UB 250	2 1/2"	10	Teklif İsteyiniz
UB 300	3"	10	Teklif İsteyiniz
UB 400	4"	10	Teklif İsteyiniz

**UZUN TRİFONLU KELEPÇE**

Kod	Ölçü mm.	Sıkma Aralığı	Birim Fiyatı Adet / USD
TK1-050	1/2"	20-25	Teklif İsteyiniz
TK1-075	3/4"	25-30	Teklif İsteyiniz
TK1-100	1"	31-38	Teklif İsteyiniz
TK1-125	1-1/4"	38-45	Teklif İsteyiniz
TK1-150	1-1/2"	45-52	Teklif İsteyiniz
TK1-200	2"	59-66	Teklif İsteyiniz
TK1-250	2 1/2"	75-84	Teklif İsteyiniz
TK1-300	3"	84-93	Teklif İsteyiniz
TK1-400	4"	110-119	Teklif İsteyiniz

**KISA TRİFONLU KELEPÇE**

Kod	Ölçü mm.	Sıkma Aralığı	Birim Fiyatı Adet / USD
TK-050	1/2"	20-25	Teklif İsteyiniz
TK-075	3/4"	25-30	Teklif İsteyiniz
TK-100	1"	31-38	Teklif İsteyiniz
TK-125	1-1/4"	38-45	Teklif İsteyiniz
TK-150	1-1/2"	45-52	Teklif İsteyiniz
TK-200	2"	59-66	Teklif İsteyiniz
TK-250	2 1/2"	75-84	Teklif İsteyiniz
TK-300	3"	84-93	Teklif İsteyiniz
TK-400	4"	110-119	Teklif İsteyiniz

**GALVANİZ REDÜKSİYON**

Kod	Ölçü mm.	Kutu Adedi	Birim Fiyatı Adet / USD
RB1	1/2"-3/8"	10	Teklif İsteyiniz
RB2	3/4"-1/2"	10	Teklif İsteyiniz
RB3	1"-1/2"	10	Teklif İsteyiniz
RB4	1"-3/4"	10	Teklif İsteyiniz
RB5	1 1/4"-1/2"	10	Teklif İsteyiniz
RB6	1 1/4"-3/4"	10	Teklif İsteyiniz
RB7	1 1/4"-1"	10	Teklif İsteyiniz
RB8	1 1/2"-1/2"	10	Teklif İsteyiniz
RB9	1 1/2"-3/4"	10	Teklif İsteyiniz
RB10	1 1/2"-1"	5	Teklif İsteyiniz
RB11	1 1/2"-1 1/4"	5	Teklif İsteyiniz
RB12	2"-1/2"	5	Teklif İsteyiniz
RB13	2"-3/4"	5	Teklif İsteyiniz

**SOMUNLU KELEPÇE**

Kod	Ölçü mm.	Sıkma Aralığı	Birim Fiyatı Adet / USD
SLK-050	1/2"	20-25	Teklif İsteyiniz
SLK-075	3/4"	25-30	Teklif İsteyiniz
SLK-100	1"	31-38	Teklif İsteyiniz
SLK-125	1-1/4"	38-45	Teklif İsteyiniz
SLK-150	1-1/2"	45-52	Teklif İsteyiniz
SLK-200	2"	59-66	Teklif İsteyiniz
SLK-250	2 1/2"	75-84	Teklif İsteyiniz
SLK-300	3"	84-93	Teklif İsteyiniz
SLK-400	4"	110-119	Teklif İsteyiniz

**90° DERECE MUFLU VİDALI DİRSEK**

Kod	Ölçü mm.	Kutu Adedi	Birim Fiyatı Adet / USD
ICE050	1/2"	50	Teklif İsteyiniz
ICE075	3/4"	50	Teklif İsteyiniz

**GALVANİZ KABLO ÇEKME ÇORABI**

Kod	Çekme Kapasitesi (ton)	Kablo Çapı	Birim Fiyatı Adet / USD
OCC01	1,0	3-10	Teklif İsteyiniz
OCC02	1,5	11-20	Teklif İsteyiniz
OCC03	2,0	21-30	Teklif İsteyiniz
OCC04	3,0	31-40	Teklif İsteyiniz
OCC05	5,0	41-60	Teklif İsteyiniz
OCC06	9,0	61-80	Teklif İsteyiniz
OCC07	9,0	81-100	Teklif İsteyiniz

**TIRNAKLI BORU KELEPÇESİ**

Kod	Ölçü mm.	Kutu Adedi	Birim Fiyatı Adet / USD
TBK 050	1/2"	50	Teklif İsteyiniz
TBK 075	3/4"	50	Teklif İsteyiniz
TBK 100	1"	50	Teklif İsteyiniz
TBK 125	1-1/4"	50	Teklif İsteyiniz
TBK 150	1-1/2"	50	Teklif İsteyiniz
TBK 200	2"	50	Teklif İsteyiniz



**EVF serisi EX-PROOF FLUORESAN ARMATÜRLERİ**
**EVF SERİSİ ARMATÜR**

Sertifika Kodu	Kullanım Sahası	Koruma Sınıfı	Sertifika No	Sıcaklık	Sınıflandırma	Gövde	Boya
II 2 G Ex ed IIB Gb II 2 D Ex IIIC IP 66 Db	Zone 1/2 Zone 21/22	IP 67	MP 11 ATEX 0084	T5-100 T4-180	Grup II - Kategori 2G/2D	Alüminyum	Elektrostatik Boya
Kod	Ampul Güç	Ampul Tipi	Duy Tipi	Giriş Diş Ölçü	Ölçü (mm)	Ağırlık (kg)	Birim Fiyatı
EVF 236	2X36W	T8	G13	2 x 1/2"	325 x 1300 x 130	16,30	Teklif İsteyiniz
EVF 218	2X18W	T8	G13	2 x 1/2"	325 x 700 x 130	9,80	Teklif İsteyiniz
EVF 136	1X36W	T8	G13	2 x 1/2"	325 x 1300 x 130	-	Teklif İsteyiniz
EVF 118	1X18W	T8	G13	2 x 1/2"	325 x 700 x 130	-	Teklif İsteyiniz
EVF 18	1X8W	T8	G13	2 x 1/2"	325 x 400 x 130	-	Teklif İsteyiniz

**EV SERİSİ EX-PROOF TAVANA MONTAJ TİPİ ARMATÜR**

Sertifika Kodu	Kullanım Sahası	Koruma Sınıfı	Sertifika No	Sıcaklık	Sınıflandırma	Gövde	Boya
II2 G/D Ex d II	Zone 1/2 Zone 21/22	IP 67	MP 11 ATEX 0077.X	T5-100 T4-180	Grup II - Kategori 2G/2D	NBR / Kafes Paslanmaz Çelik	Elektrostatik Boya
Kod	Ampul Güç	Ampul Tipi	Duy Tipi	Giriş Diş Ölçü	Ölçü (mm)	Ağırlık (kg)	Birim Fiyatı
EVC100	60W, 80W, 100W	T6	E 27	1/2" - 3/4"	330 x 180	4,88	Teklif İsteyiniz
EVC200	160W, 200W,	T6	E 27	1/2" - 3/4"	330 x 180	4,88	Teklif İsteyiniz
EVC250	250W	T6	E 40	1/2" - 3/4"	330 x 180	4,88	Teklif İsteyiniz
EVC300	300W	T6	E 40	1/2" - 3/4"	330 x 180	8,82	Teklif İsteyiniz

**EJB TERMİNAL KUTULARI / PANELLER**

Sertifika Kodu	Kullanım Sahası	Koruma Sınıfı	Sertifika No	Sınıflandırma	Gövde	Boya	Civata		
II 2 G Ex ed IIB Gb II 2 D Ex IIIC IP 66 Db	Zone 1/2 Zone 21/22	IP 67	MP 11 ATEX 0084	Grup II - Kategori 2G/2D	Alüminyum	Elektrostatik Boya	Paslanmaz Çelik		
Kod	Dış Ölçüler (mm)			İç Ölçüler (mm)				Ağırlık (kg)	Birim Fiyatı
	A	B	C	X	Y	Z	W		
EJB.1	210	175	140	140	95	100	85	-	Teklif İsteyiniz
EJB.2	270	220	180	195	140	140	117	-	Teklif İsteyiniz
EJB.3	285	215	190	215	145	135	105	-	Teklif İsteyiniz
EJB.4	470	330	235	390	245	180	140	-	Teklif İsteyiniz
EJB.5	540	325	280	440	235	170	145	-	Teklif İsteyiniz
EJB.6	670	420	330	560	320	260	225	-	Teklif İsteyiniz
EJB.7	750	450	330	655	350	260	230	-	Teklif İsteyiniz
EJB.8	1050	520	410	925	430	340	290	-	Teklif İsteyiniz

**EX-PROOF POLYESTER FLOURESAN ARMATÜR**

Sertifika Kodu	Kullanım Sahası	Koruma Sınıfı	Sıcaklık	Gövde				
Ex II 2 GD Ex deq IIC T4/Ex II2 D Extb NIC T80°C Db	Zone 1/ Zone 2 Zone 21/ Zone 22	IP 67	-20+55	Polyester gövdeli, tavan tipi ve elektronik balastlı				
BAY51-Q36x1X	1x36 / 40W	T8	G13	4xM25	220-240V - 50Hz	222x1380x134	11.3 kg	Teklif İsteyiniz
BAY51-Q36x2X	2x36 / 40W	T8	G13	4xM25	220-240V - 50Hz	222x1380x134	11.4 kg	Teklif İsteyiniz

**ALÜMİNYUM BUATLAR**
**IP 67**

Kod	Ölçü	Ambalaj	Birim Fiyat (TL)	Kod	Ölçü	Ambalaj	Birim Fiyat (TL)
ALMB 01	100 x 100 x 73	100	63,90	ALMB 10	80 x 80 x 60	100	50,00
ALMB 02	100 x 130 x 73	50	85,64	ALMB 11	80 x 130 x 60	65	65,64
ALMB 03	130 x 190 x 90	30	177,65	ALMB 12	130 x 230 x 90	14	206,00
ALMB 04	170 x 190 x 90	12	205,00	ALMB 13	160 x 160 x 90	20	178,00
ALMB 05	250 x 250 x 110	4	420,00	ALMB 14	65 x 65 x 40	30	35,00
ALMB 06	190 x 250 x 90	8	365,00	ALMB 15	65 x 100 x 40	20	44,00
ALMB 07	80 x 170 x 73	40	91,00	ALMB 16	80 x 80 x 73	80	54,00
ALMB 08	130 x 130 x 90	30	145,00	ALMB 17	160 x 160 x 90	20	215,00
ALMB 09	190 x 350 x 90	6	395,00	ALMB 18	180 x 180 x 100	10	178,00

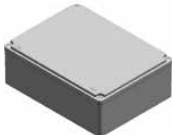



**SKP SIKMALI KABLO PAPUÇLARI**
**Standart Tip**

Kod	Kablo Kesiti mm.	Civata	Ambalaj Miktarı
SKPS 10	10	M 5	800
SKPS 16	16	M 6	500
SKPS 25	25	M 8	350
SKPS 35	35	M 8	200
SKPS 50	50	M 10	150
SKPS 70	70	M 10	100
SKPS 95	95	M 12	80
SKPS 120	120	M 12	70
SKPS 150	150	M 12	30
SKPS 185	185	M 16	30
SKPS 240	240	M 16	25
SKPS 300	300	M 16	20
SKPS 400	400	M 20	10
SKPS 500	500	M 20	10
SKPS 625	625	M 20	6

 ŞAFAK  
LİSTE  
FİYATI  
GEÇERLİDİR

**Eko Tip**

Kod	Kablo Kesiti mm.	Civata	Ambalaj Miktarı
SKPE 10	10	M 5	1200
SKPE 16	16	M 6	800
SKPE 25	25	M 8	400
SKPE 35	35	M 8	300
SKPE 50	50	M 10	200
SKPE 70	70	M 10	130
SKPE 95	95	M 12	100
SKPE 120	120	M 12	70
SKPE 150	150	M 12	50
SKPE 185	185	M 16	30
SKPE 240	240	M 16	30

 ŞAFAK  
LİSTE  
FİYATI  
GEÇERLİDİR

**DINTİP**

Kod	Kablo Kesiti mm.	Civata	Ambalaj Miktarı
SKPD 10	10	M 6	500
SKPD 16	16	M 6	250
SKPD 25	25	M 8	200
SKPD 35	35	M 10	120
SKPD 50	50	M 10	65
SKPD 70	70	M 10	50
SKPD 95	95	M 12	30
SKPD 120	120	M 12	30
SKPD 150	150	M 12	25
SKPD 185	185	M 12	18
SKPD 240	240	M 12	12
SKPD 300	300	M 16	10
SKPD 400	400	M 16	10
SKPD 500	500	M 20	-
SKPD 625	625	M 20	-

 ŞAFAK  
LİSTE  
FİYATI  
GEÇERLİDİR

**DAĞITICI ÜNİTELER**

Kod	Cinsi	Amper	A	B	C	L	Birim Fiyatı TL
DNT-207	2 KUTUP 7 DELİK	125 A	44,5	52,5	42	66	19,00
DNT-215	2 KUTUP 15 DELİK	125 A	44,5	52,5	42	133	32,00
DNT-407	4 KUTUP 7 DELİK	125 A	44,5	52,5	85	66	33,00
DNT-411	4 KUTUP 11 DELİK	125 A	44,5	52,5	85	101	50,00
DNT-415	4 KUTUP 15 DELİK	125 A	44,5	52,5	85	133	60,00



**STANDART KABLO BAřLARI (Beyaz/Siyah)**

Kod	Uzunluk mm.	En mm.	Renk	Bařlama apı mm	Ambalaj Miktarı		Birim Fiyatı
					Paket	Koli	
OKB 2,5 x 100	100	2,5	BEYAZ - SIYAH	18	1.000	70.000	ŞAFAK LİSTE FİYATI GEÇERLİDİR
OKB 2,5 x 150	150	2,5	BEYAZ - SIYAH	35	1.000	55.000	
OKB 2,5 x 160	160	2,5	BEYAZ - SIYAH	40	1.000	45.000	
OKB 2,5 x 200	200	2,5	BEYAZ - SIYAH	50	1.000	32.000	
OKB 3,6 x 150	150	3,6	BEYAZ - SIYAH	35	100	30.000	
OKB 3,6 x 200	200	3,6	BEYAZ - SIYAH	50	100	20.000	
OKB 3,6 x 250	250	3,6	BEYAZ - SIYAH	65	100	20.000	
OKB 3,6 x 300	300	3,6	BEYAZ - SIYAH	76	100	17.000	
OKB 3,6 x 370	370	3,6	BEYAZ - SIYAH	102	100	12.000	
OKB 4,8 x 200	200	4,8	BEYAZ - SIYAH	50	100	16.000	
OKB 4,8 x 250	250	4,8	BEYAZ - SIYAH	60	100	12.000	
OKB 4,8 x 300	300	4,8	BEYAZ - SIYAH	76	100	11.000	
OKB 4,8 x 370	370	4,8	BEYAZ - SIYAH	102	100	9.000	
OKB 4,8 x 430	430	4,8	BEYAZ - SIYAH	110	100	7.500	
OKB 7,6 x 300	300	7,6	BEYAZ - SIYAH	76	100	5.000	
OKB 7,6 x 370	370	7,6	BEYAZ - SIYAH	102	100	4.000	
OKB 7,6 x 430	430	7,6	BEYAZ - SIYAH	110	100	2.500	
OKB 7,6 x 530	530	7,6	BEYAZ - SIYAH	140	100	2.000	
OKB 9,0 x 780	780	9	BEYAZ - SIYAH	228	100	2.000	

**YAPIŞKAN KROŞELER**

Kod	Ölü mm.	Ambalaj Miktarı	Birim Fiyatı
OYK 1030	19 x 19	100	Şafak Liste
OYK 1031	28 x 28	100	Şafak Liste

**PASLANMAZ ELİK KABLO BAřLARI**

Kod	Boy	En	Aıklama Mukavemeti	Bařlama apı	Ambalaj Adeti	304 Kalite Birim Fiyatı	316 Kalite Birim Fiyatı
CKB-150C	150	4,6	65	44	100	Fiyat İsteyiniz	
CKB-200C	200	4,6	65	51	100		
CKB-250C	250	4,6	65	69	100		
CKB-300C	300	4,6	65	75	100		
CKB-350C	350	4,6	65	102	100		
CKB-550C	550	4,6	65	152	100		
CKB-700C	700	4,6	65	203	100		
CKB-850C	850	4,6	65	254	100		
CKB-200D	200	7,9	130	51	100		
CKB-300D	300	7,9	130	75	100		
CKB-370D	370	7,9	130	102	100		
CKB-520D	520	7,9	130	152	100		
CKB-680D	680	7,9	130	203	100		
CKB-850D	850	7,9	130	254	100		

**U KLEMENSLER (MS58 Pirin)**

Kod	Cinsi	Kutu Adedi	Birim Fiyatı TL
UK06	6 Lik U Klemens	150	2,25
UK10	10 Luk U Klemens	125	3,82
UK16	16 Lik U Klemens	100	5,76
UK25	25 Lik U Klemens	100	7,86
UK35	35 Lik U Klemens	75	8,78
UK50	50 Lik U Klemens	50	14,83
UK70	70 Lik U Klemens	40	17,54
UK95	95 Lik U Klemens	25	23,72
UK120	120 Lik U Klemens	20	26,93
UK150	150 Lik U Klemens	15	41,14

**İZOLELİ TEK GİRİŞLİ KABLO YÜKSÜKLERİ**

Kod	Kablo Kesit mm.	Ölçüler		Ambalaj Miktarı	Birim Fiyatı
		F	L		
IY 0,50/8	0,5	8	14	1.000	ŞAFAK LİSTE FİYATI GEÇERLİDİR
IY 0,75/8	0,75	8	14	1.000	
IY 1,0/8	1	8	14	1.000	
IY 1,50/8	1,5	8	14	1.000	
IY 2,50/8	2,5	8	14	500	
IY 4/8	4	8	17	500	
IY 6/12	6	12	20	250	
IY 10/12	10	12	22	100	
IY 16/12	16	12	24	100	
IY 25/16	25	16	30	50	
IY 35/16	35	16	30	50	
IY 50/20	50	20	36	25	
IY 70/21	70	21	37	25	

**İZOLESİZ TEK GİRİŞLİ KABLO YÜKSÜKLERİ**

Kod	Kablo Kesit mm.	Ölçüler		Ambalaj Miktarı	Birim Fiyatı
		F	L		
KY 0,50/10	0,5	10	10	1.000	ŞAFAK LİSTE FİYATI GEÇERLİDİR
KY 0,75/10	0,75	10	10	1.000	
KY 1,0/10	1	10	10	1.000	
KY 1,50/10	1,5	10	10	1.000	
KY 2,50/12	2,5	12	12	1.000	
KY 4/12	4	12	12	1.000	
KY 6/12	6	12	12	1.000	
KY 10/15	10	15	15	500	
KY 16/15	16	15	15	200	
KY 25/16	25	16	16	200	
KY 35/16	35	16	16	100	
KY 50/22	50	22	22	50	

**İZOLELİ ÇİFT GİRİŞLİ KABLO YÜKSÜKLERİ**

Kod	Kablo Kesit mm.	Ölçüler		Ambalaj Miktarı	Birim Fiyatı
		F	L		
CY 0,50/8	2 x 0,5	8	14	1.000	ŞAFAK LİSTE FİYATI GEÇERLİDİR
CY 0,75/8	2 x 0,75	8	14	500	
CY 1,0/8	2 x 1,0	8	14	500	
CY 1,50/8	2 x 1,5	8	14	500	
CY 2,50/10	2 x 2,5	10	14	250	
CY 4/12	2 x 4	12	17	200	
CY 6/14	2 x 6	14	20	100	
CY 10/14	2 x 10	14	21	100	
CY 16/14	2 x 16	14	31	50	

**İZOLELİ YUVARLAK KABLO UÇLARI**

Kod	Kablo Kesit mm.	Metrik Ölçü	Renk	Ambalaj Miktarı	Birim Fiyatı
YU 401	4	200			
YU 501	5	200			
YU 601	6	200			
YU 801	8	200			
YU 302	1,5 - 2,5	3	MAVİ	200	
YU 402		4		100	
YU 502		5		100	
YU 602		6		200	
YU 802		8		200	
YU 1002		10		100	
YU 1202		12		100	
YU 406	4 - 6	4	SARI	100	
YU 506		5		100	
YU 606		6		100	
YU 806		8		100	
YU 1006		10		100	
YU 1206		12		100	



**İZOLELİ ÇATAL TİP KABLO UÇLARI**

Kod	Kablo Kesit mm.	Metrik Ölçü	Renk	Ambalaj Miktarı	Birim Fiyatı TL
ÇU 3001	0,5 - 1,5	3	KIRMIZI	200	ŞAFAK LİSTE FİYATI GEÇERLİDİR
ÇU 4001		4		200	
ÇU 5001		5		200	
ÇU 6001		6		200	
ÇU 3002	1,5 - 2,5	3	MAVİ	200	
ÇU 4002		4		200	
ÇU 5002		5		200	
ÇU 6002		6		200	
ÇU 4006	4 - 6	4	SARI	100	
ÇU 5006		5		100	
ÇU 6006		6		100	
ÇU 8006		8		100	

**İZOLELİ FATSON DIŞI KABLO UÇLARI**

FD 1288	0,5 - 1,5	2,8	KIRMIZI	200	ŞAFAK LİSTE FİYATI GEÇERLİDİR
FD 1488		4,8		200	
FD 1638		6,3		200	
FD 2288	1,5 - 2,5	2,8	MAVİ	200	
FD 1488		4,8		200	
FD 1638		6,3		200	
FD 5638	4 - 6	6,3	SARI	100	

**İZOLELİ FATSON ERKEK KABLO UÇLARI**

FE 1288	0,5 - 1,5	2,8	KIRMIZI	200	ŞAFAK LİSTE FİYATI GEÇERLİDİR
FE 1488		4,8		200	
FE 1638		6,3		200	
FE 2488	1,5 - 2,5	2,8	MAVİ	200	
FE 1638		4,8		200	
FE 5638	4 - 6	6,3	SARI	100	

**TAM İZOLELİ FATSON DIŞI KABLO UÇLARI**

FFD 1488	0,5 - 1,5	4,8	KIRMIZI	200	ŞAFAK LİSTE FİYATI GEÇERLİDİR
FFD 1638		6,3		200	
FFD 2488		4,8		200	
FFD 2688	1,5 - 2,5	6,3	MAVİ	200	
FFD 5638	4 - 6	6,3	SARI	200	



**YAYLI START - STOP BUTON SERİSİ**
**Metal Serisi**

Kod	Kontakt	Renk	Ambalaj Miktarı	Birim Fiyatı USD
LAY5 - BA21	1 N/A	SİYAH	20	1,79
LAY5 - BA31	1 N/A	YEŞİL	20	1,79
LAY5 - BA51	1 N/A	SARI	20	1,79
LAY5 - BA61	1 N/A	MAVİ	20	1,79
LAY5 - BA42	1 N/K	KIRMIZI	20	1,79

**YAYLI İŞARETLİ START - STOP BUTON SERİSİ**

LAY5 - BA3311	1 N/A	YEŞİL	20	1,97
LAY5 - BA3341	1 N/A	BEYAZ	20	1,97
LAY5 - BA3351	1 N/A	SİYAH	20	1,97
LAY5 - BA3322	1 N/A	KIRMIZI	20	1,97
LAY5 - BA3342	1 N/K	KIRMIZI	20	1,97

**MANTAR KAFA KALICI**

Kod	Ölçü	Kontakt	Renk	Ambalaj Miktarı	Birim Fiyatı USD
LAY5 - BS542	Ø 40	1 N/K	KIRMIZI	20	2,41
LAY5 - BS642	Ø 60	1 N/K	KIRMIZI	20	2,54

**MANTAR KAFA ANAHTARLI KALICI**

LAY5 - BS142	Ø 40	1 N/K	KIRMIZI	20	5,90
--------------	------	-------	---------	----	------

**MANTAR KAFA YAYLI**

LAY5 - BC42	Ø 40	1 N/K	KIRMIZI	20	2,63
LAY5 - BR42	Ø 60	1 N/K	KIRMIZI	20	2,70

**ANAHTARLI BUTON**

Kod	Operasyon	Kontakt	Renk	Ambalaj Miktarı	Birim Fiyatı USD
LAY5 - BG21	TEK TARAF KALICI [0-1]	1 N/A	SİYAH	20	3,59
LAY5 - BA33	SAĞ - SOL KALICI [1-0-2]	1 N/A	SİYAH	20	3,59

**KISA MANDAL BUTON**

LAY5 - BD21	TEK TARAF KALICI [0-1]	1 N/A	SİYAH	20	1,88
LAY5 - BD33	SAĞ - SOL KALICI [1-0-2]	2 N/A	SİYAH	20	2,41
LAY5 - BD41	TEK TARAF YAYLI [0-(1)]	1 N/A	SİYAH	20	1,88
LAY5 - BD53	SAĞ - SOL YAYLI [1]-0-[2]	2 N/A	SİYAH	20	2,41

**UZUN MANDAL BUTON**

LAY5 - BJ21	TEK TARAF KALICI [0-1]	1 N/A	SİYAH	20	3,08
LAY5 - BJ33	SAĞ - SOL KALICI [1-0-2]	2 N/A	SİYAH	20	3,08
LAY5 - BJ41	TEK TARAF YAYLI [0-(1)]	1 N/A	SİYAH	20	2,41
LAY5 - BJ53	SAĞ - SOL YAYLI [1]-0-[2]	2 N/A	SİYAH	20	2,41

**YAYLI İKİZ BUTONLARI**

LAY5 - BL8425	1 N/A + 1 N/K	YEŞİL + KIRMIZI	20	3,49
LAY5 - BW8475	1 N/A + 1 N/K	YEŞİL + KIRMIZI	20	5,25

**YAYLI START - STOP BUTON SERİSİ - LEDLİ**

LAY5 - BW3371	1 N/A 01	YEŞİL	20	3,68
LAY5 - BW3472	1 N/A 01	KIRMIZI	20	3,68

**TEK TARAFLI KALICI 2 KONTAKLI MANDAL BUTON - LEDLİ**

LAY5 - BK2365	1 N/A + 1 N/K 0-1	YEŞİL	20	4,38
LAY5 - BK2375	1 N/A + 1 N/K 0-1	KIRMIZI	20	4,38

**YAYLI START - STOP BUTON SERİSİ**

Plastik Serisi

Kod	Kontakt	Renk	Ambalaj Miktarı	Birim Fiyatı USD
LAY5 - EA31	1 N/A	YEŞİL	20	1,18
LAY5 - EA51	1 N/A	SARI	20	1,27
LAY5 - EA42	1 N/K	KIRMIZI	20	1,18
LAY5 - EA21	1 N/K	SIYAH	20	1,27

**YAYLI İŞARETLİ START - STOP BUTON SERİSİ**

LAY5 - EA3311	1 N/A	YEŞİL	20	1,40
LAY5 - EA3341	1 N/A	BEYAZ	20	1,40
LAY5 - EA3351	1 N/A	SIYAH	20	1,40
LAY5 - EA3322	1 N/K	KIRMIZI	20	1,40
LAY5 - EA3342	1 N/A	KIRMIZI	20	1,40

**MANTAR KAFA YAYLI BUTON**

LAY5 - EC42	1 N/K	KIRMIZI	20	1,88
-------------	-------	---------	----	------

**MANTAR KAFA KALICI BUTON**

Kod	Ölçü/Operasyon	Kontakt	Renk	Ambalaj Miktarı	Birim Fiyatı USD
LAY5 - ES542	Ø 40	1 N/K	KIRMIZI	20	1,88
LAY5 - ES642	Ø 60	1 N/K	KIRMIZI	20	1,88

**KISA MANDAL BUTON**

LAY5 - ED21	TEK TARAF KALICI (0-1)	1 N/A	SIYAH	20	1,36
LAY5 - ED33	SAĞ - SOL KALICI (1-0-2)	2 N/A	SIYAH	20	1,93
LAY5 - ED41	TEK TARAF YAYLI (0-(1))	1 N/A	SIYAH	20	1,36
LAY5 - ED53	SAĞ - SOL YAYLI (1)-0-(2)	2 N/A	SIYAH	20	1,93

**ANAHTARLI BUTON**

LAY5 - EG21	TEK TARAF KALICI (0-1)	1 N/A	SIYAH	20	2,54
LAY5 - EG33	SAĞ SOL KALICI (1-0-2)	2 N/A	SIYAH	20	3,06

**YAYLI İKİZ BUTON**

LAY5 - EL8325	1 N/A + 1N/K	YEŞİL + KIRMIZI	20	3,06
---------------	--------------	-----------------	----	------

**LEDLİ SİNYAL LAMBASI - Ø 22**

TB5 - AD22K	220 V/50 HZ	KIRMIZI	10	1,16
TB5 - AD22Y	220 V/50 HZ	YESİL	10	1,16
TB5 - AD22S	220 V/50 HZ	SARI	10	1,16
TB5 - AD22M	220 V/50 HZ	MAVI	10	1,58
TB5 - AD22B	220 V/50 HZ	BEYAZ	10	1,58

220 V



24 V

TB5 - AD24K	24 V/AC/DC	KIRMIZI	10	1,16
TB5 - AD24Y	24 V/AC/DC	YESİL	10	1,16
TB5 - AD24S	24 V/AC/DC	SARI	10	1,16
TB5 - AD24M	24 V/AC/DC	MAVI	10	1,58
TB5 - AD24B	24 V/AC/DC	BEYAZ	10	1,58



220 V

**LEDLİ SİNYAL LAMBASI - Ø 16**

TB5 - AD16B22K	220 V/50 HZ	KIRMIZI	10	1,16
TB5 - AD16B22Y	220 V/50 HZ	YESİL	10	1,16
TB5 - AD16B22S	220 V/50 HZ	SARI	10	1,16

24 V



TB5 - AD16B24K	24 V/AC/DC	KIRMIZI	10	1,35
TB5 - AD16B24Y	24 V/AC/DC	YESİL	10	1,35
TB5 - AD16B24S	24 V/AC/DC	SARI	10	1,35



220 V

**LEDLİ BUZZERLAR - Ø 16**

TB5 - AD22BZI	220 V/50 HZ-İŞIKLI		10	3,05
TB5 - AD24BZI	24 V/AC/DC-İŞIKLI		10	3,05



**REVİZYON KUTUSU (Mıknatıslı)**

Kod	Operasyon	Ambalaj Miktarı	Birim Fiyatı USD
LAY5-DJBOS444	<b>METAL</b> YUKARI - AŞAĞIMANDAL - MANTAR	20	15,75
LAY5-DJBOS444P	<b>PLASTİK</b> YUKARI - AŞAĞIMANDAL - MANTAR	20	14,13

**İKİLİ MANDALLI VE ACİL STOP KUMANDA KUTUSU**

XALB132H129	START-STOP	1	3,50
XALB164H129	STOP	1	3,50

**KUMANDA KUTUSU BOŞ SİYAH - BEYAZ**

Kod	Buton Sayısı	Ambalaj Miktarı	Birim Fiyatı USD
HC91G	1	1	1,44
HC92G	2	1	2,05
HC93G	3	1	2,45
HC94G	4	1	3,15

**KUMANDA KUTUSU BOŞ SİYAH - SARI**

Kod	Buton Sayısı	Ambalaj Miktarı	Birim Fiyatı USD
HC91S	1	1	1,44
HC92S	2	1	2,05
HC93S	3	1	2,45
HC94S	4	1	3,15

**YAYLI START - STOP KUMANDA KUTUSU**

Kod	Etiket	Ambalaj Miktarı	Birim Fiyatı USD
XALB103	START	1	3,17
XALB114	STOP	1	3,17

**İKİLİ START - STOP KUMANDA KUTUSU**

Kod	Etiket	Ambalaj Miktarı	Birim Fiyatı USD
XALB215	START-STOP	1	4,16
XALB366	START-STOP	1	7,04

**JOYSTICK BUTON**

XD2PA12	2 POZİSYON N/A	1	5,50
XD2PA14	4 POZİSYON N/A	1	10,30

**VİNÇ KUMANDA KUTUSU**

COB61	2'li	1	3,28
COB62	4'lü	1	6,34
COB62A	6'li	1	6,34

**METAL AYAK PEDALI**

Kod	Kontak	Renk	Ambalaj Miktarı	Birim Fiyatı USD
FS3	1 N/A + 1 N/K	GRİ	1	6,39
LT4SMFP	1 N/A + 1 N/K	GRİ	1	17,50

**KONTAK BLOĞU**

Kod	Kontak	Renk	Ambalaj Miktarı	Birim Fiyatı USD
ZB2BE101	1 N/A	YEŞİL	20	0,63
ZB2BE102	1 N/K	KIRMIZI	20	0,63





## ORTAC WATERPROOF & SUPERSEAL CONNECTORS

### ORTAC CUSTOMIZED CONNECTORS

#### LED WATERPROOF CONNECTORS

##### TECHNICAL DETAILS

Contact	: Brass nickel plated
Current Rating	: 2pin:5A - 4pin:3A
Voltage Rating	: 220V AC
Contact Resistance	: <10M $\Omega$
Insulation Resistance	: 1000M $\Omega$ at DC 500 V.
Breakdown Voltage	: 1,5KV / 1 min.
Temperature Rate	: -30~85°C
Durability (Plug/Unplug)	: 3000 times
Waterproof Rating	: IP67
Cable Max. Dia.	: 2pin/4pin: $\varnothing$ 6mm.
Pins Range	: 2,4 pin
Certificate	: CE; RoHS



#### Waterproof Connector

**Available Cable Sizes:** 2x0,75, 4x0,50

**Available pin Sizes:** 2,4

**Application Area:** LED technologies, Superior industrial machines and equipments, power&signal control components.

### ORTAC CUSTOMIZED CONNECTORS

#### SUPERSEAL CONNECTORS

##### TECHNICAL DETAILS

Material	: Housing and secondary lock: polyamide 6.6 glass filled,
Resistant to	: Ozone, salts (CACI2-NACL), gasoline, diesel fuel, brake fluid detergents, anti-freeze coolant, transmission gear lubricant, motor oil.
Waterproof Rating	: IP67
Temperature Rate	: -40°C +125°C
Insulation Resistance	: min. 200 M $\Omega$
Dielectric with standing Voltage	: 1500 Vrms
Temperature Rise	: see fig. 1 diagram
TAB	:
Material	: Brass tin plated laceless contact
Wire size range	: 20-16 AWG
Current Rating	: 14 Amp maximum
Insertion force	: max. 8 N
Contact resistance	: max. 3 m $\Omega$ (test current 10 mA)









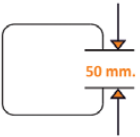

#### Superseal Connectors

**Available Cable Sizes:** 2x0,50,2x0,75, 2x1 / 3x0,50,3x0,75,3x1 / 4x0,50,4x0,75,4x1

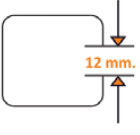
**Available pin Sizes:** 2,3,4

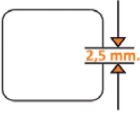
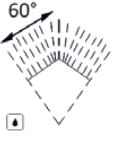
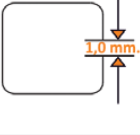
**Application Area:** Automotive & Lighting Industries to connect cables with safety way.

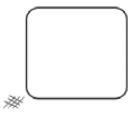
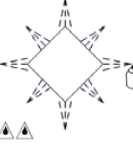
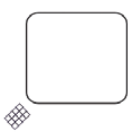
IP 68 = IP AÇILIMI ..... IP  
 1. HANE ..... 6  
 2. HANE ..... 8

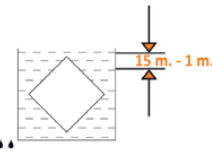
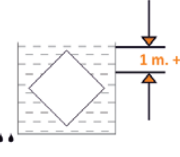
1. HANE	Katı Cisimlere Karşı Koruma Değerleri	2. HANE	Sıvı Maddelere Karşı Koruma Değerleri
0	Korumasız	0	Korumasız
1	 50 mm'den büyük katı cisimlere karşı	1	 Damlayan suya karşı korumalı
2	 12 mm'den büyük katı cisimlere karşı	2	 15 dereceye kadar damlayan su
3	 2,5 mm'den büyük katı cisimlere karşı	3	 60 dereceye kadar damlayan su
4	 1,0 mm'den büyük katı cisimlere karşı	4	 Sıçrayan suya karşı korumalı
5	 Toza karşı korumalı	5	 Su püskürtmesi
6	 Toz geçirmez	6	 Şiddetli deniz dalgası
		7	 1,5 m. - 1 m. Suya daldırma
		8	 1 m. + Su altında bırakma

# TÜRKİYE GENELİ & 5 KITADA 40 FARKLI ÜLKEDE 100'ÜN ÜZERİNDE SATIŞ AĞI





 **ORTAC**<sup>®</sup>  
Kablo Baęlantı Elemanları



**ORTAÇLAR ELEKTRİK SAN. ve TİC. LTD. ŞTİ.**  
**Adres:** Hadımköy Mah. İbni Sina Cad. No: 9 Arnavutköy/İstanbul  
**T. +90 212 858 19 00 F. +90 212 858 19 59**

[www.ortac.com.tr](http://www.ortac.com.tr)